



Designation: E2126 – 11 (Reapproved 2018)

Standard Test Methods for Cyclic (Reversed) Load Test for Shear Resistance of Vertical Elements of the Lateral Force Resisting Systems for Buildings¹

This standard is issued under the fixed designation E2126; the number immediately following the designation indicates the year of original adoption or, in the case of revision, the year of last revision. A number in parentheses indicates the year of last reapproval. A superscript epsilon (ϵ) indicates an editorial change since the last revision or reapproval.

1. Scope

1.1 These test methods cover the evaluation of the shear stiffness, shear strength, and ductility of the vertical elements of lateral force resisting systems, including applicable shear connections and hold-down connections, under quasi-static cyclic (reversed) load conditions.

1.2 These test methods are intended for specimens constructed from wood or metal framing braced with solid sheathing or other methods or structural insulated panels.

1.3 The values stated in inch-pound units are to be regarded as standard. The values given in parentheses are mathematical conversions to SI units that are provided for information only and are not considered standard.

1.4 *This standard does not purport to address all of the safety concerns, if any, associated with its use. It is the responsibility of the user of this standard to establish appropriate safety, health, and environmental practices and determine the applicability of regulatory limitations prior to use.*

1.5 *This international standard was developed in accordance with internationally recognized principles on standardization established in the Decision on Principles for the Development of International Standards, Guides and Recommendations issued by the World Trade Organization Technical Barriers to Trade (TBT) Committee.*

2. Referenced Documents

2.1 *ASTM Standards:*²

D2395 Test Methods for Density and Specific Gravity (Relative Density) of Wood and Wood-Based Materials

¹ These test methods are under the jurisdiction of ASTM Committee E06 on Performance of Buildings and are the direct responsibility of Subcommittee E06.11 on Horizontal and Vertical Structures/Structural Performance of Completed Structures.

Current edition approved July 1, 2018. Published July 2018. Originally approved in 2001. Last previous edition approved in 2011 as E2126 – 11. DOI: 10.1520/E2126-11R18.

² For referenced ASTM standards, visit the ASTM website, www.astm.org, or contact ASTM Customer Service at service@astm.org. For *Annual Book of ASTM Standards* volume information, refer to the standard's Document Summary page on the ASTM website.

D4442 Test Methods for Direct Moisture Content Measurement of Wood and Wood-Based Materials

D4444 Test Method for Laboratory Standardization and Calibration of Hand-Held Moisture Meters

E564 Practice for Static Load Test for Shear Resistance of Framed Walls for Buildings

E575 Practice for Reporting Data from Structural Tests of Building Constructions, Elements, Connections, and Assemblies

E631 Terminology of Building Constructions

2.2 *ISO Standard:*³

ISO 16670 Timber Structures—Joints Made with Mechanical Fasteners—Quasi-static Reversed-cyclic Test Method

2.3 *Other Standards:*⁴

ANSI/AF&PA NDS National Design Specification for Wood Construction

3. Terminology

3.1 For definitions of terms used in this standard, see Terminology E631.

3.2 *Definitions of Terms Specific to This Standard:*¹⁸

3.2.1 *ductility ratio, cyclic (D), n*—the ratio of the ultimate displacement (Δ_u) and the yield displacement (Δ_{yield}) of a specimen observed in cyclic test.

3.2.2 *elastic shear stiffness (K_e)* (see 9.1.4, Fig. 1), *n*—the resistance to deformation of a specimen in the elastic range before the first major event (FME) is achieved, which can be expressed as a slope measured by the ratio of the resisted shear load to the corresponding displacement.

3.2.3 *envelope curve* (see Fig. 2), *n*—the locus of extremities of the load-displacement hysteresis loops, which contains the peak loads from the first cycle of each phase of the cyclic loading and neglects points on the hysteresis loops where the absolute value of the displacement at the peak load is less than that in the previous phase.

³ Available from International Organization for Standardization (ISO), ISO Central Secretariat, BIBC II, Chemin de Blandonnet 8, CP 401, 1214 Vernier, Geneva, Switzerland, http://www.iso.org.

⁴ Available from American Forest & Paper Association (AF&PA), 1101 K St., NW, Suite 700, Washington, DC 20005, http://www.afandpa.org.

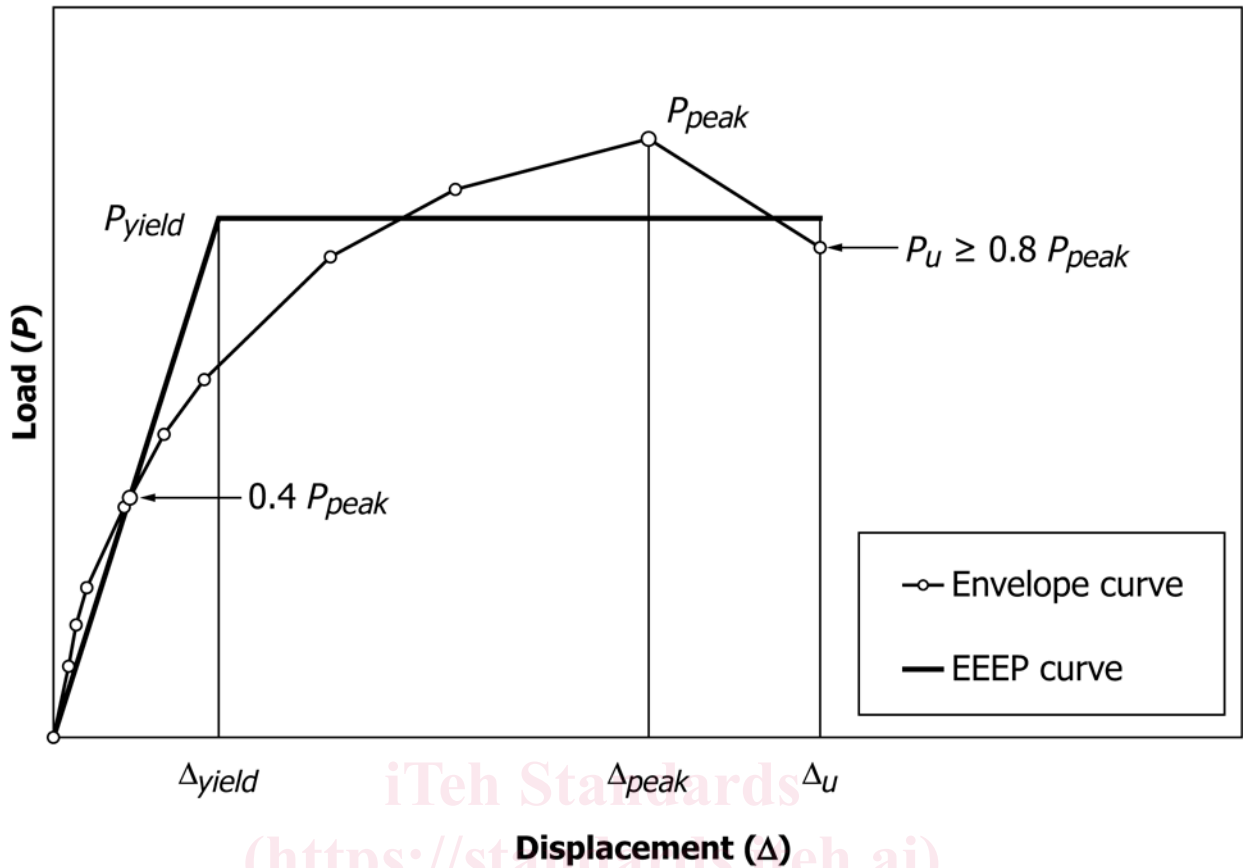

FIG. 1 Performance Parameters of Specimen: (A) Last Point at $P_u \geq 0.8 P_{peak}$

3.2.3.1 *Discussion*—Specimen displacement in the positive direction produces a positive envelope curve; the negative specimen displacement produces a negative envelope curve. The positive direction is based on outward movement of the hydraulic actuator.

3.2.4 *envelope curve, average* (see Fig. 3), n —envelope curve obtained by averaging the absolute values of load and displacement of the corresponding positive and the negative envelope points for each cycle.

3.2.5 *equivalent energy elastic-plastic (EEEEP) curve* (see 9.1.4, Fig. 1), n —an ideal elastic-plastic curve circumscribing an area equal to the area enclosed by the envelope curve between the origin, the ultimate displacement, and the displacement axis. For monotonic tests, the observed load-displacement curve is used to calculate the EEEP curve.

3.2.6 *failure limit state, n* —the point on the envelope curve corresponding to the last data point with the absolute load equal or greater than $0.8 P_{peak}$, as illustrated in Fig. 1.

3.2.7 *failure load (P_u)*, n —the load corresponding to the failure limit state.

3.2.8 *first major event (FME)*, n —the first significant limit state to occur (see *limit state*).

3.2.9 *limit state, n* —an event that demarks the two behavior states, at which time some structural behavior of the specimen is altered significantly.

3.2.10 *specimen, n* —the vertical element of the lateral force resisting system to be tested. Example of specimens are walls, structural insulated panels, portal frames, etc. A specimen can be a single element or an entire line of resistance within a lateral force resisting system.

3.2.11 *stabilized response, n* —load resistance that differs not more than 5 % between two successive cycles at the same amplitude.

3.2.12 *strength limit state* (see Fig. 1), n —the point on the envelope curve corresponding to the maximum absolute displacement Δ_{peak} at the maximum absolute load (P_{peak}) resisted by the specimen.

3.2.13 *ultimate displacement, cyclic (Δ_u)*, n —the displacement corresponding to the failure limit state in cyclic test.

3.2.14 *ultimate displacement, monotonic (Δ_m)*, n —the displacement corresponding to the failure limit state in monotonic test.

3.2.15 *yield limit state, n* —the point in the load-displacement relationship where the elastic shear stiffness of

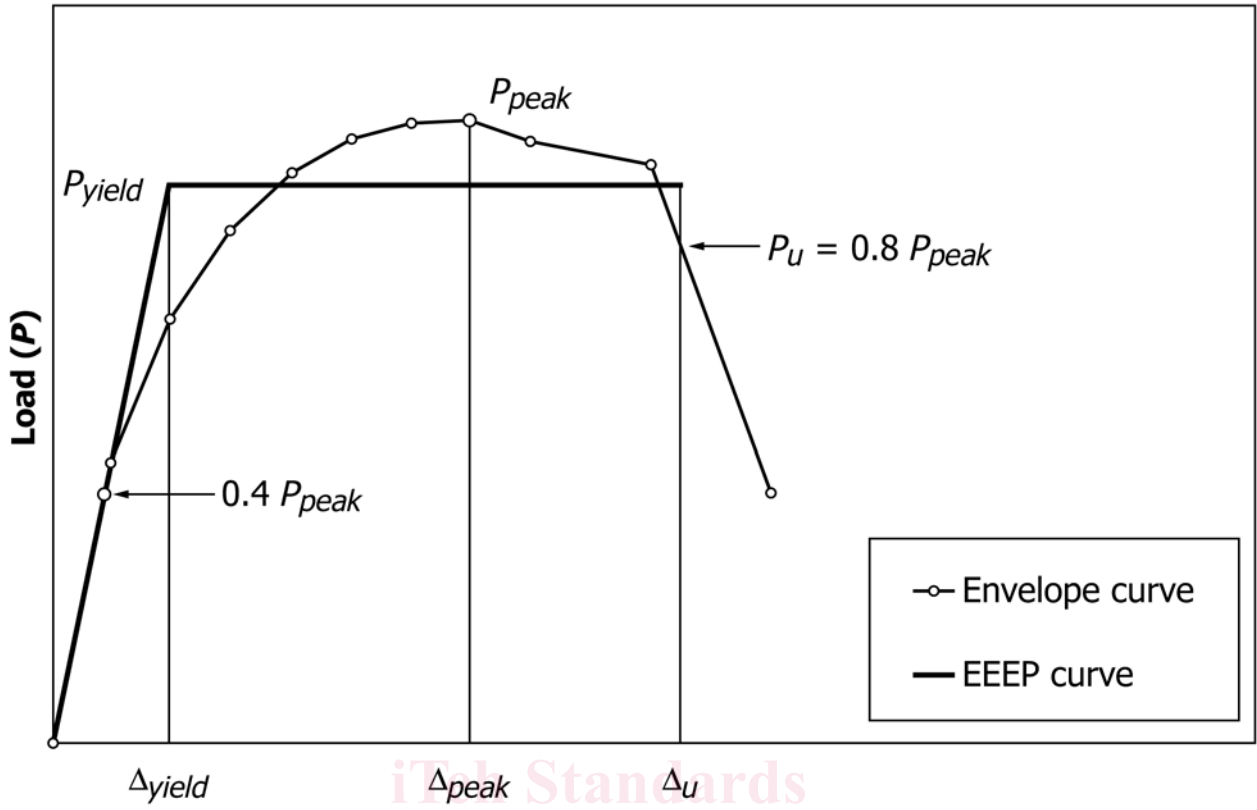

FIG. 1 Performance Parameters of Specimen: (B) Last Point at $P_u = 0.8 P_{peak}$ (continued)

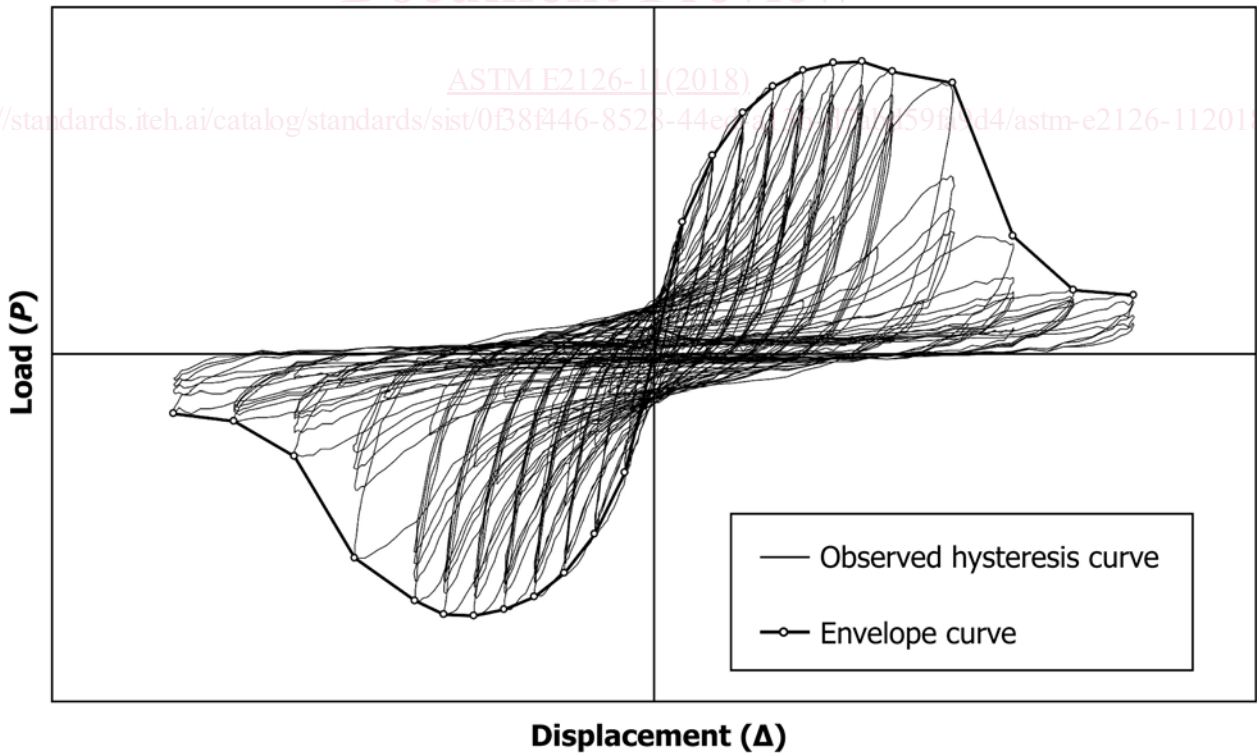

FIG. 2 Examples of Observed Hysteresis Curve and Envelope Curves for Test Method A

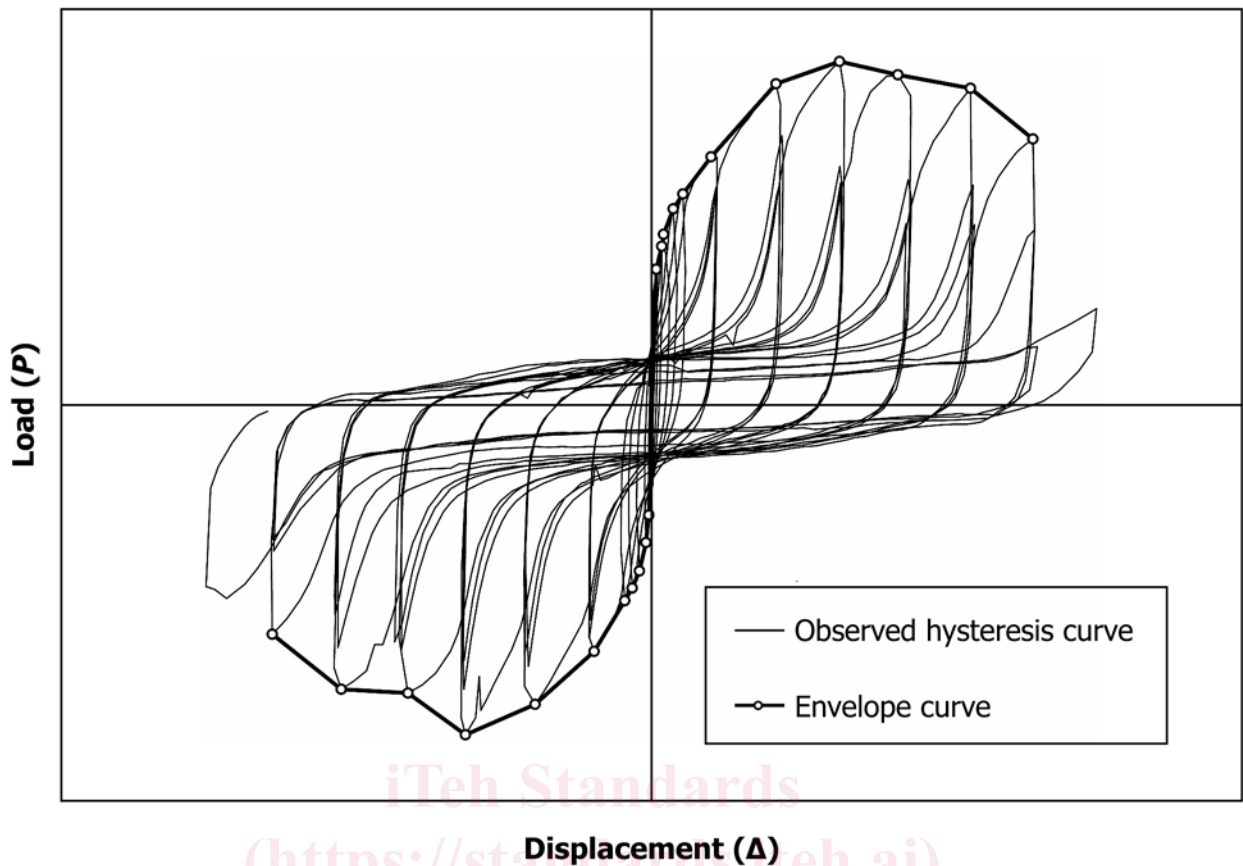

FIG. 2 Examples of Observed Hysteresis Curve and Envelope Curves for Test Method B (continued)

the assembly decreases 5 % or more. For specimens with nonlinear ductile elastic response, the yield point ($\Delta_{yield}, P_{yield}$) is permitted to be determined using the EEEP curve (see 9.1.4).

4. Summary of Test Method

4.1 The elastic shear stiffness, shear strength and ductility of specimens are determined by subjecting a specimen to full-reversal cyclic racking shear loads. This is accomplished by anchoring the bottom edge of the specimen to a test base simulating intended end-use applications and applying a force parallel to the top of the specimen. The specimen is allowed to displace in its plane. Sheathing panels that are a component of a specimen shall be positioned such that they do not bear on the test frame during testing. (See Note 1.) As the specimen is racked to specified displacement increments, the racking (shear) load and displacements are continuously measured (see 8.7).

NOTE 1—If the end-use applications require sheathing panels bear directly on the sill plate, such as most structural insulated panels, the specimen may be tested with sheathing panels that bear on the sill plate.

5. Significance and Use

5.1 These test methods are intended to measure the performance of vertical elements of the lateral force resisting system subjected to earthquake loads. Since these loads are cyclic, the loading process simulates the actions and their effects on the specimens.

6. Specimen

6.1 *General*—The typical specimen consists of a frame, bracing elements, such as panel sheathing, diagonal bracing, etc., and fastenings. The bracing is attached on one side of the frame unless the purpose of the test requires bracing on both sides. The elements of the specimen shall be fastened to the frame in a manner to conform to 6.2. Elements used to construct specimens may be varied to permit anticipated failure of selected elements. All detailing shall be clearly identified in the report in accordance with Section 10.

6.2 *Connections*—The performance of specimens is influenced by the type, spacing, and edge distance of fasteners attaching sheathing to framing and spacing of the shear connections and hold-down connectors, if applicable, and the tightness of the fasteners holding the specimen to the test base.

6.2.1 *Sheathing Panel Attachments*—All panel attachments shall be consistent with the types used in actual building construction. Structural details, such as fastener schedules, fastener edge distance, and the gap between panels, shall be reported in accordance with Section 10.

6.2.2 *Attachment to the Test Base*—Specimen shall be attached to the test base with fasteners in a manner representing field conditions. For intended use requirements over a non-rigid foundation, a mock-up flexible base shall be constructed to simulate field conditions. Consideration shall be given to the orientation and type of floor joists relative to the orientation of

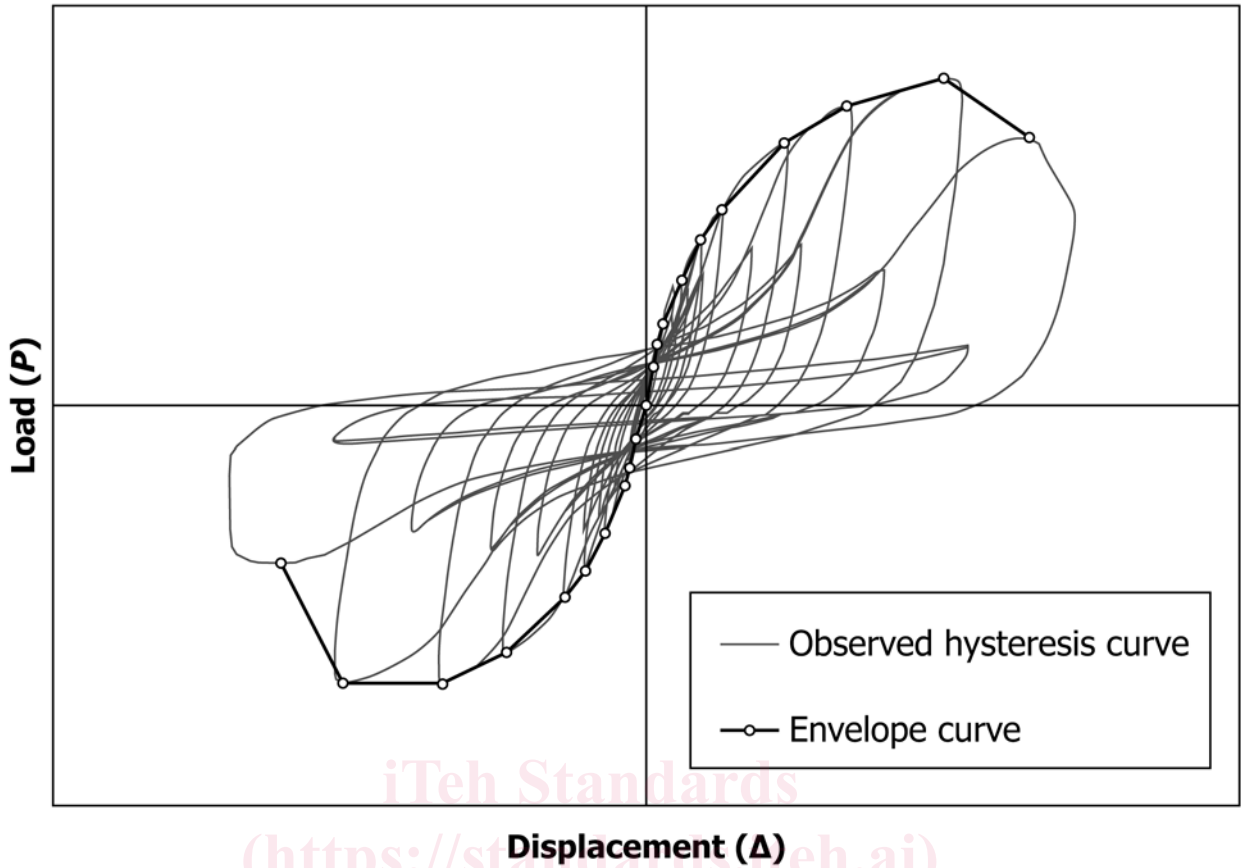

FIG. 2 Examples of Observed Hysteresis Curve and Envelope Curves for Test Method C (continued)

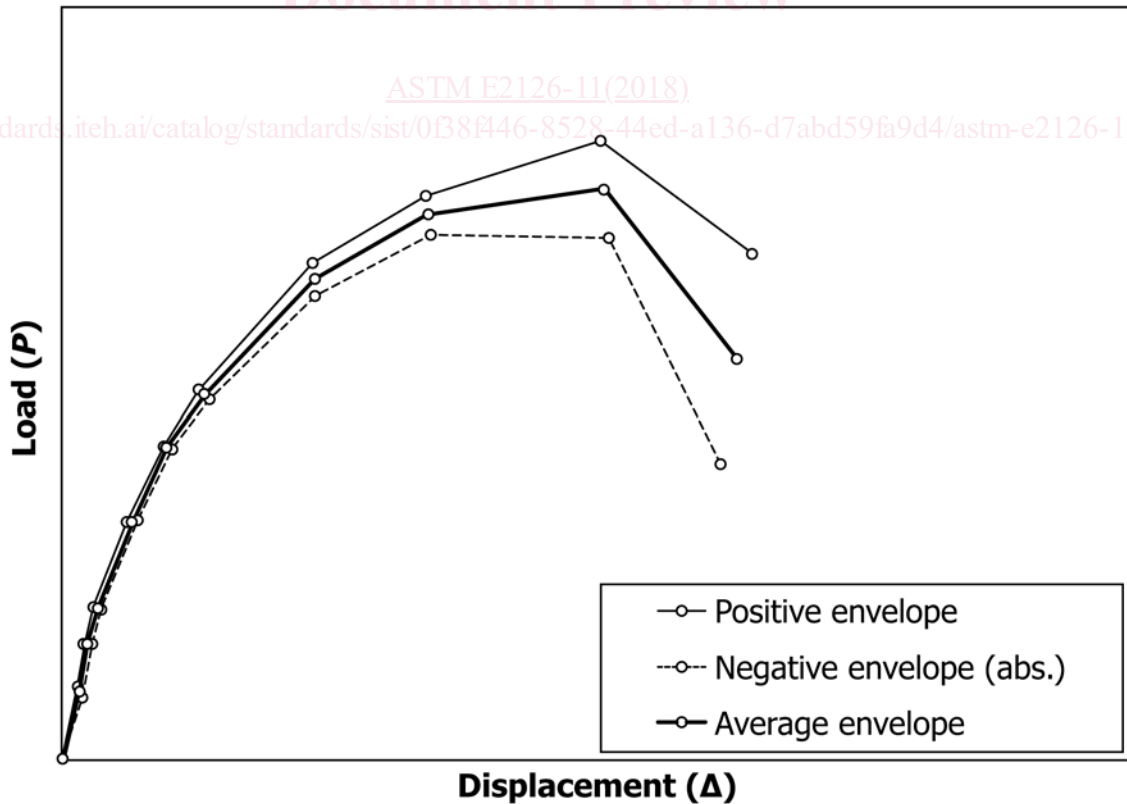

FIG. 3 Example of Average Envelope Curve (see Fig. 2, Test Method C)

the wall assembly. When strap connections are used, they shall be installed (that is, inside/outside the sheathing, etc.) without pre-tension in a configuration that simulates the field application. The test report shall include details regarding this attachment.

6.2.3 *Anchor and Hold-Down Bolts*—When the specimen frame is made of solid wood or wood-based composites, the anchor bolts shall be tightened to no more than finger tight plus a 1/8 turn, provided that the design value of stress perpendicular to the grain is not exceeded (see Note 2). The hold-down bolts shall be tightened consistently between replicates in accordance with hold-down manufacturer’s recommendation. The assembly test shall not start within 10 min of the anchor bolt tightening to allow for stress relaxation of the anchor.

NOTE 2—Since solid wood and wood-based composites relax over time as well as potentially shrink due to changing moisture content, the intent of the finger tight plus a 1/8 turn is to avoid any significant pre-tension on the anchor bolts, which may affect the test results. It is the committee judgment that the maximum bolt tension should not be more than 300 lbf (1.33 kN) for the purpose of ensuring the bolt is not caught on a thread or not seated fully. It should be noted that, however, the bolt tension depends on wood species and density, bolt thread pitch (or bolt diameter), and plate washer size. A general rule of thumb is to finger-tight plus 1/8 turn, which will result in a nut displacement of approximately 0.01 in. (0.254 mm) for 1/2 and 5/8-in.-diameter (12.7 and 15.9-mm-diameter) UNC bolts. A torque of about 50 lbf-in. (5.65 kN-mm) without bolt lubrication would normally produce 300 lbf (1.33 kN) of bolt tension.

6.3 *Frame Requirements*—The frame of the specimen shall consist of materials representative of those to be used in the

actual building construction. The connections of these members shall be consistent with those intended in actual building construction.

6.3.1 For wood framing members, record the species and grade of lumber used (or the relevant product identification information for structural composite lumber framing); moisture content of the framing members at the time of the specimen fabrication and testing, if more than 24 h passes between these operations (see Test Methods D4442, Test Methods A or B; or D4444, Test Methods A or B); and specific gravity of the framing members (see Test Methods D2395, Test Method A). The specific gravity of the framing members shall be representative of the published specific gravity for the product with no individual member exceeding the published value by more than 10 % (see ANSI/AF&PA NDS for example).

6.3.2 For steel or other metal framing members, record the material specifications and thickness.

6.4 *Structural Insulated Panel*—The panel is prefabricated assembly consisting of an insulating core of 1.5 in. (38 mm) minimum sandwiched between two facings. The assembly is constructed by attaching panels together and to top and bottom plates or tracks.

6.5 *Specimen Size*—The specimen shall have a height and length or aspect (height/length) ratio that is consistent with intended use requirements in actual building construction (see Fig. 4).

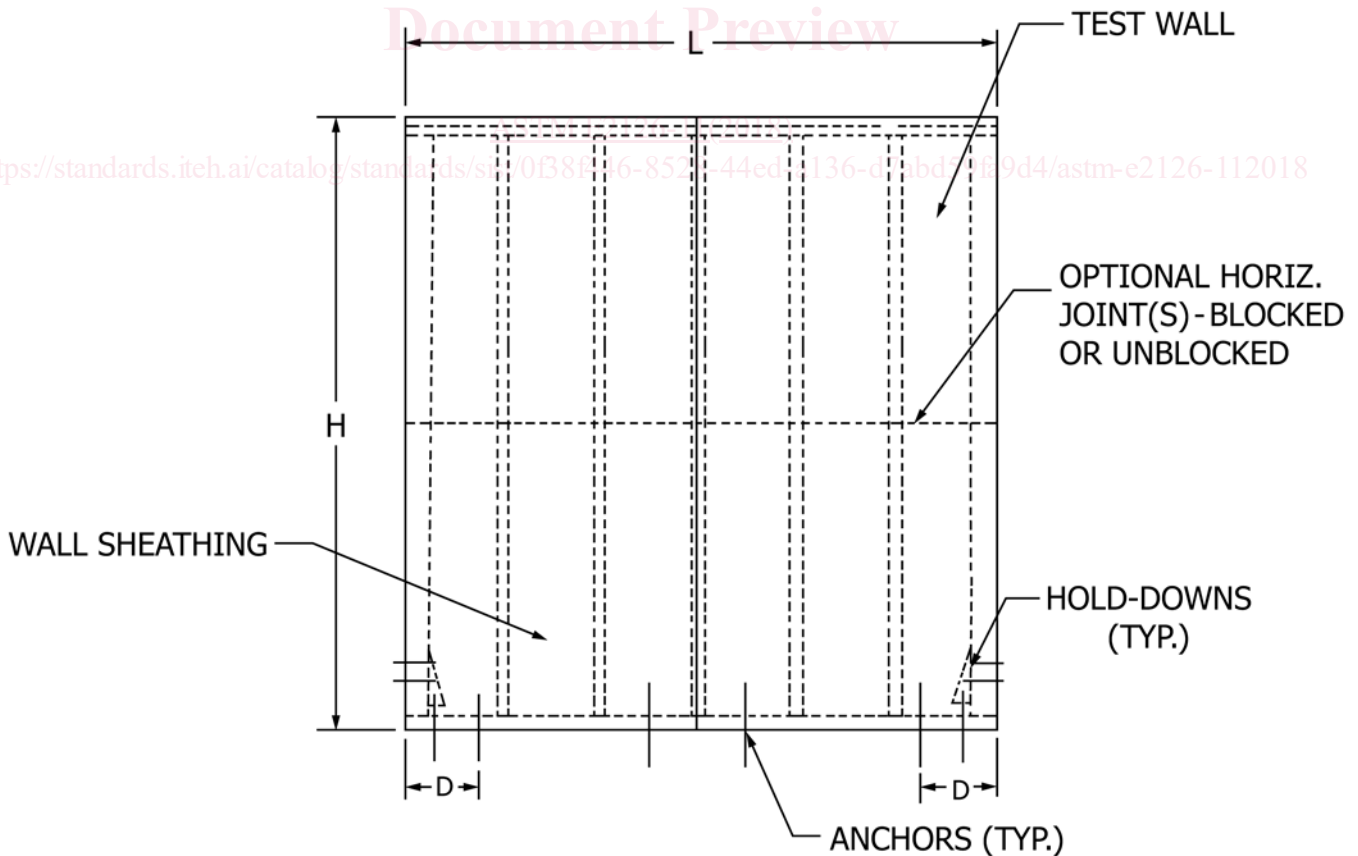

FIG. 4 An Example of Shear Wall Specimen