



Designation: **D5236—18 D5236 – 18a**

## Standard Test Method for Distillation of Heavy Hydrocarbon Mixtures (Vacuum Potstill Method)<sup>1</sup>

This standard is issued under the fixed designation D5236; the number immediately following the designation indicates the year of original adoption or, in the case of revision, the year of last revision. A number in parentheses indicates the year of last reapproval. A superscript epsilon ( $\epsilon$ ) indicates an editorial change since the last revision or reapproval.

### 1. Scope\*

1.1 This test method covers the procedure for distillation of heavy hydrocarbon mixtures having initial boiling points greater than 150 °C (300 °F), such as heavy crude oils, petroleum distillates, residues, and synthetic mixtures. It employs a potstill with a low pressure drop entrainment separator operated under total takeoff conditions. Distillation conditions and equipment performance criteria are specified and typical apparatus is illustrated.

1.2 This test method details the procedures for the production of distillate fractions of standardized quality in the gas oil and lubricating oil range as well as the production of standard residue. In addition, it provides for the determination of standard distillation curves to the highest atmospheric equivalent temperature possible by conventional distillation.

1.3 The maximum achievable atmospheric equivalent temperature (AET) is dependent upon the heat tolerance of the charge. For most samples, a temperature up to 565 °C (1050 °F) can be attained. This maximum will be significantly lower for heat sensitive samples (for example, heavy residues) and might be somewhat higher for nonheat sensitive samples.

1.4 The recommended distillation method for crude oils up to cutpoint 400 °C (752 °F) AET is Test Method **D2892**. This test method can be used for heavy crude oils with initial boiling points greater than 150 °C (302 °F). However, distillation curves and fraction qualities obtained by these methods are not comparable.

1.5 This test method contains the following annexes:

1.5.1 **Annex A1**—Test Method for Determination of Temperature Response Time,

1.5.2 **Annex A2**—Practice for Calibration of Sensors,

1.5.3 **Annex A3**—Test Method for Dehydration of a Wet Sample of Oil,

1.5.4 **Annex A4**—Practice for Conversion of Observed Vapor Temperature to Atmospheric Equivalent Temperature (AET), and

1.5.5 **Annex A5**—Test Method for Determination of Wettage.

1.6 The values stated in SI units are to be regarded as standard. The values given in parentheses after SI units are provided for information only and are not considered standard.

1.7 *This standard does not purport to address all of the safety concerns, if any, associated with its use. It is the responsibility of the user of this standard to establish appropriate safety, health, and environmental practices and determine the applicability of regulatory limitations prior to use.* For specific warnings, see **6.5.4.2**, **6.5.6.3**, **6.9.3**, **9.5**, **9.7**, and **A2.3.1.3**.

1.8 **WARNING**—Mercury has been designated by many regulatory agencies as a hazardous material substance that can cause central nervous system, kidney, and liver damage, serious medical issues. Mercury, or its vapor, may have been demonstrated to be hazardous to health and corrosive to materials. Caution should be taken—Use Caution when handling mercury and mercury containing mercury-containing products. See the applicable product Material Safety Data Sheet (MSDS) for details and EPA's website—<http://www.epa.gov/mercury/faq.htm>—for additional information. Users should be aware (SDS) for additional information. The potential exists that selling mercury and/or mercury containing products into your state or country may be prohibited by law, or mercury-containing products, or both, is prohibited by local or national law. Users must determine legality of sales in their location.

1.9 *This international standard was developed in accordance with internationally recognized principles on standardization established in the Decision on Principles for the Development of International Standards, Guides and Recommendations issued by the World Trade Organization Technical Barriers to Trade (TBT) Committee.*

<sup>1</sup> This test method is under the jurisdiction of ASTM Committee **D02** on Petroleum Products, Liquid Fuels, and Lubricants and is the direct responsibility of Subcommittee **D02.08** on Volatility.

Current edition approved April 1, 2018/July 1, 2018. Published April 2018/July 2018. Originally approved in 1992. Last previous edition approved in 2017/2018 as D5236-17-18. DOI: [10.1520/D5236-18](https://doi.org/10.1520/D5236-18); [10.1520/D5236-18A](https://doi.org/10.1520/D5236-18A).

\*A Summary of Changes section appears at the end of this standard

## 2. Referenced Documents

### 2.1 ASTM Standards:<sup>2</sup>

- D941 Test Method for Density and Relative Density (Specific Gravity) of Liquids by Lipkin Bicapillary Pycnometer (Withdrawn 1993)<sup>3</sup>
- D1217 Test Method for Density and Relative Density (Specific Gravity) of Liquids by Bingham Pycnometer
- D1250 Guide for Use of the Petroleum Measurement Tables
- D1298 Test Method for Density, Relative Density, or API Gravity of Crude Petroleum and Liquid Petroleum Products by Hydrometer Method
- D1480 Test Method for Density and Relative Density (Specific Gravity) of Viscous Materials by Bingham Pycnometer
- D2892 Test Method for Distillation of Crude Petroleum (15-Theoretical Plate Column)
- D4057 Practice for Manual Sampling of Petroleum and Petroleum Products
- D4177 Practice for Automatic Sampling of Petroleum and Petroleum Products
- D5002 Test Method for Density and Relative Density of Crude Oils by Digital Density Analyzer

## 3. Terminology

### 3.1 Definitions of Terms Specific to This Standard:

- 3.1.1 *boil-up rate, n*—the quantity of vapor entering the distillation head per unit time.

---

<sup>2</sup> For referenced ASTM standards, visit the ASTM website, [www.astm.org](http://www.astm.org), or contact ASTM Customer Service at [service@astm.org](mailto:service@astm.org). For *Annual Book of ASTM Standards* volume information, refer to the standard's Document Summary page on the ASTM website.

<sup>3</sup> The last approved version of this historical standard is referenced on [www.astm.org](http://www.astm.org).

#### 3.1.1.1 Discussion—

It is approximately equal to the takeoff rate, differing only by the parasitic heat losses. It is expressed in millilitres per hour for a head of any given internal diameter or millilitres per hour per square centimetre of cross-sectional area of the throat for comparative purposes.

- 3.1.2 *condenser, n*—the apparatus connected to the outlet of the distillation head in which condensation of the product occurs.
- 3.1.3 *distillation flask, n*—the flask, of glass or metal, in which the charge is boiled.

#### 3.1.3.1 Discussion—

The flask is sometimes called a kettle or pot.

- 3.1.4 *distillation head, n*—the section immediately above the distillation flask containing the entrainment separator.
- 3.1.5 *distillation pressure (or operating pressure), n*—the pressure measured in the distillation head just before the outlet to the recovery system.
- 3.1.6 *distillation temperature (or vapor temperature), n*—the temperature of the vapors in the distillation head at the point of measurement.
- 3.1.7 *loading, n*—the volume of charge relative to the cross-sectional area of the neck.
- 3.1.8 *pressure drop, n*—the difference between the operating pressure and the pressure measured in the distillation flask.

#### 3.1.8.1 Discussion—

It is a result of the friction developed by driving the vapors through the system expressed in kilopascals (mm Hg).

- 3.1.9 *spillover point, n*—the lowest point in the head above the entrainment separator over which the vapors can flow to the condensing region.
- 3.1.10 *static hold-up (or wettag), n*—the amount of liquid material remaining on the inside of the walls of the apparatus after the distillation has been completed.

#### 3.1.10.1 Discussion—

In this test method, it includes wettag of the distillation flask in the case of the steel flasks, but not in the case of glass flasks that are removed for weighing after the distillation is completed.

- 3.1.11 *takeoff rate, n*—the quantity of product removed per unit time.

### 3.1.11.1 Discussion—

It is approximately equal to the boil-up rate differing only by parasitic heat losses.

## 4. Summary of Test Method

4.1 A weighed volume of sample is distilled at absolute pressures between 6.6 kPa and 0.013 kPa (50 mm Hg and 0.1 mm Hg) at specified distillation rates. Cuts are taken at preselected temperatures. Records of vapor temperature, operating pressure, and other variables are made at intervals, including at each cutpoint.

4.2 The mass of each fraction is obtained. Distillation yields by mass are calculated from the mass of each fraction relative to the total mass recovery.

4.3 The density of each fraction is obtained. Distillation yields by volume are calculated from the volume computed for each fraction at 15 °C (59 °F) relative to the total recovery.

4.4 Distillation curves of temperature versus mass or volume percent, or both, are drawn using the data from 4.2 and 4.3.

## 5. Significance and Use

5.1 This test method is one of a number of tests conducted on heavy hydrocarbon mixtures to characterize these materials for a refiner or a purchaser. It provides an estimate of the yields of fractions of various boiling ranges.

5.2 The fractions made by this test method can be used alone or in combination with other fractions to produce samples for analytical studies and quality evaluations.

5.3 Residues to be used in the manufacture of asphalt can also be made but may not always be suitable. The long heat soaking that occurs in this test method may alter some of the properties.

NOTE 1—While the practice of reblending distillates with residue can be done to produce a lighter residue, it is not recommended because it produces blends with irregular properties.

5.4 Details of cutpoints must be mutually agreed upon before the test begins.

5.5 This is a complex procedure involving many interacting variables. It is most important that at the time of first use of a new apparatus, its components be checked as detailed in Annex A1 and Annex A2 and that the location of the vapor temperature sensor be verified as detailed in 6.5.3 and Fig. 1.

## 6. Apparatus

6.1 Four sizes of apparatus, based upon the internal diameter of the distillation head (25 mm, 36 mm, 50 mm, and 70 mm), are allowed.<sup>4</sup> The apparatus (see Fig. 2) consists of a flask with heating mantles, an upper compensator, and a head containing an entrainment separator. Attached to the head are the vapor temperature sensor, a connection for the vacuum gauge, a condenser, a rundown line, a product receiver(s), and a vacuum pumping line with pump. The parts are connected by vacuum-tight joints to facilitate servicing.

### 6.2 Distillation Flask:

6.2.1 The sizes specified for flasks are at least 50 % larger than the size of the charge to provide space for suppression of foam and for bubble breaking. The size of the charge for each size of still is determined from the loading factor. The recommended loading factor is between 200 mL and 400 mL of charge per square centimetre of cross-sectional area in the neck of the head. Table 1 shows the range of charge volume that is recommended with each size of apparatus.

6.2.2 Flasks are made of borosilicate glass except those larger than 10 L, which are made of stainless steel for reasons of safety.

6.2.3 The flask is fitted with a thermowell reaching to within 6 mm of the bottom and offset from the center to avoid a stirring bar. In the case of glass flasks, the bottom shall be slightly flattened or slightly concave, but not perfectly flat to facilitate the rotation of the magnetic stirrer. Steel flasks can have a cooling coil for rapid quenching of the distillation in an emergency. Fig. 3 shows a typical example.

6.3 *Stirring System*—A magnetically driven stirring bar approximately 3 mm diameter and 20 mm long shall be provided for the glass flasks, or 6 mm diameter by 50 mm long for the steel flasks. The edges shall be rounded to minimize grinding the wall of the flask. The external magnetic drive must be capable of rotating the bar in the flask when located directly below and touching the mantle. The drive can be used to support the apparatus above. An adjustable jacking mechanism is recommended for raising and lowering the stirrer.

### 6.4 Heating System:

6.4.1 The flask shall be heated by means of a nickel-reinforced quartz fabric heating mantle on the lower half so that boiling rates of up to 150 mL/h per cm<sup>2</sup> of the cross-sectional area of the neck can be maintained. A heat density of 0.5 W/cm<sup>2</sup> is adequate. Usually two or more circuits are used to improve heat control by applying automatic heat to the bottom circuit.

<sup>4</sup> Cooke, *Industrial and Engineering Chemistry*, Vol 55, 1963, p. 36.

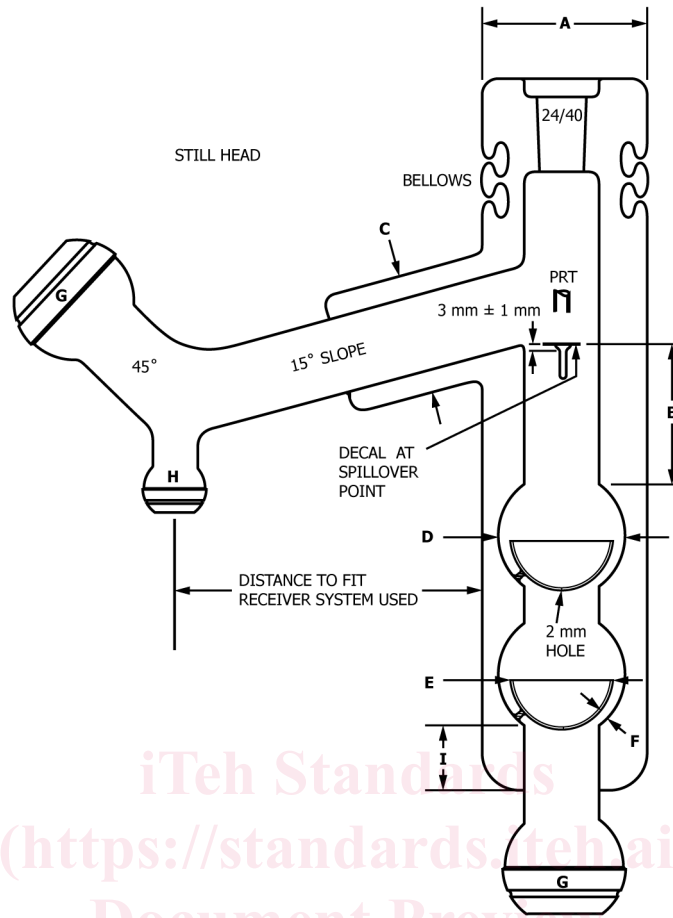

STILL HEAD DIMENSION CHART

Size	A	B	C	D	E	F	G	H	I
25 mm	85 mm	75 mm	64 mm	47 mm ID	40 mm OD	4–5 mm	35/25	28/15	35 mm
36 mm	90 mm	75 mm	64 mm	68 mm ID	57 mm OD	5–6 mm	65/40	35/25	35 mm
50 mm	110 mm	100 mm	75 mm	94 mm ID	79 mm OD	7–9 mm	75/50	35/25	45 mm
70 mm	140 mm	100 mm	100 mm	131 mm ID	111 mm OD	10–11 mm	102/75	50/30	70 mm

FIG. 1 Distillation Head

6.4.2 A temperature sensor shall be located between the wall of the flask and the mantle for control of the skin temperature.

6.4.3 The upper half of the flask shall be covered with a mantle to compensate for heat losses. A heat density of 0.2 W/cm<sup>2</sup> is adequate.

6.5 Distilling Head:

6.5.1 The head shall conform to the details shown in Fig. 1. It shall be made of borosilicate glass and be totally enclosed in a silvered glass vacuum jacket having a permanent vacuum of less than 0.0001 kPa (0.00075 mm Hg).

6.5.2 The head shall be enclosed in a heat-insulating system such as a glass fabric mantle capable of maintaining the outer wall of the glass vacuum jacket at a temperature 5 °C below the internal vapor temperature in the head. For this purpose, the vacuum jacket shall have a temperature sensor fastened to the outer wall of the jacket at a point level with the vapor temperature sensor and opposite to the outlet arm of the head.

6.5.3 The head shall be fitted with an adapter to support the vapor temperature sensor so that it is held centered in the neck with the top of the sensing tip 3 mm ± 1 mm below the spillover point. This dimension can be checked by removing the temperature sensor and inserting in its place a copper wire having a short right angle bend at the bottom. By feeling for the spillover point, the distance from the top joint of the adaptor can be found. Laying the wire on the temperature sensor will then permit checking of this dimension.

6.5.4 The vapor temperature sensor shall be either a platinum resistance thermometer, a thermocouple with the junction head fused to the lower tip of the well, or any other device which meets the requirements in 6.5.4 and 6.5.4.1. It shall have a response time of less than 60 s as described in Annex A1.

6.5.4.1 The vapor temperature measuring device shall have an accuracy of 0.5 °C or better and be measured with a resolution of 0.1 °C or better.

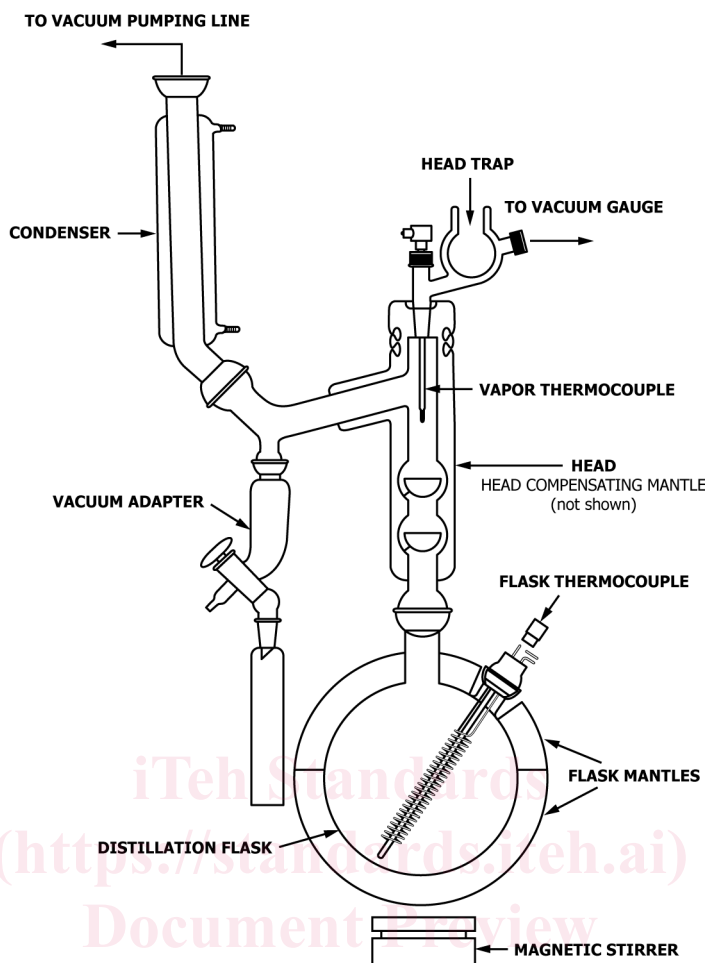

FIG. 2 Apparatus

TABLE 1 Standard Charge and Flask Size

Inside Diameter, mm	Throat Cross-Sectional Area, cm <sup>2</sup>	Charge, L	Flask, L
25	5	1–2	2–3
36	10	2–4	3–6
50	20	4–8	6–12
70	40	8–16	12–24

6.5.4.2 The vapor temperature measuring device shall be calibrated over the full range of useful temperatures in combination with its associated instrument at the time of first use and at least once per year thereafter as described in A2.2.2. Alternatively, certified sensors may be used, provided the calibration of the sensor and its associated recording instrument can be traced back to a primary temperature standard. Recalibrate when either the sensor or the instrument is repaired or serviced. (**Warning**—Vapor temperature measurement is one of the two major sources of error in distillation data.)

6.5.4.3 Verification of the calibration of the vapor temperature measuring devices is to be made on a regular basis. Verification at least once a month is recommended. Verification of the calibration of the sensors can be accomplished potentiometrically by the use of standard precision resistance or by distilling a pure compound with accurately known boiling point, as described in A2.2.3.

6.5.5 A head trap as illustrated in Fig. 4 shall be fitted to the adapter described in 6.5.3 for connection to the vacuum sensor. It shall be kept filled with crushed dry ice at all times while in service.

6.5.6 A vacuum sensor shall be connected to the sidarm of the trap. The sensor shall be capable of reading the pressure with a precision equal to or better than 0.00133 kPa (0.01 mm Hg), whichever is greater. A non-tilting McLeod gauge or other primary reference device can achieve this accuracy when properly used, but a mercury manometer will permit this accuracy only down to a pressure of about 1 kPa and then only when read with a good cathetometer (an instrument based on a telescope mounted on a vernier scale to determine levels very accurately). Also, electronic sensors of the diaphragm type have been found satisfactory. Vacuum gauges based on hot wires, radiation, or conductivity detectors are not recommended.

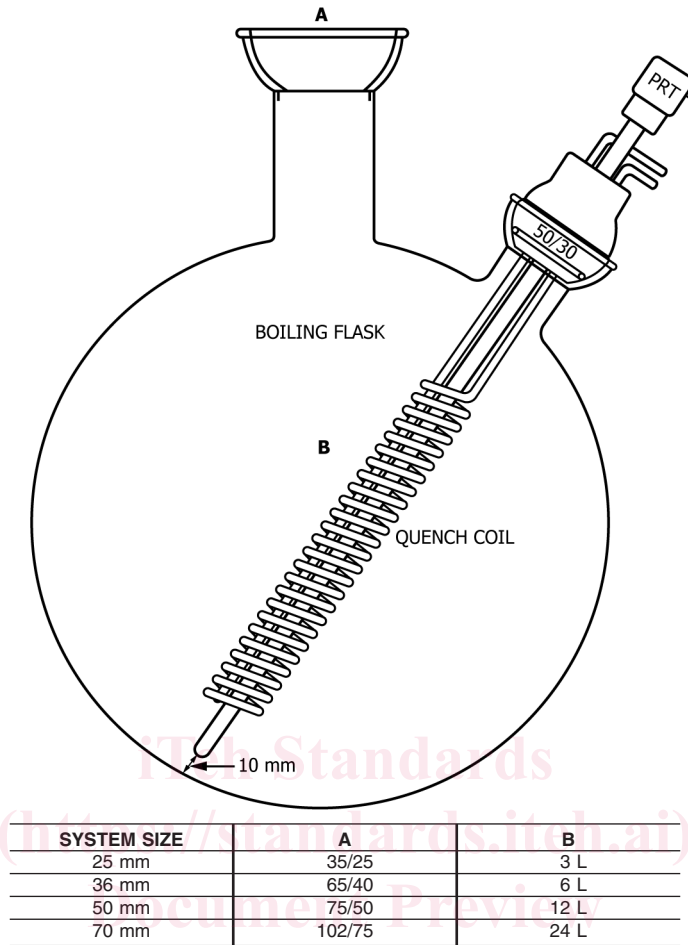

FIG. 3 Distillation Flask

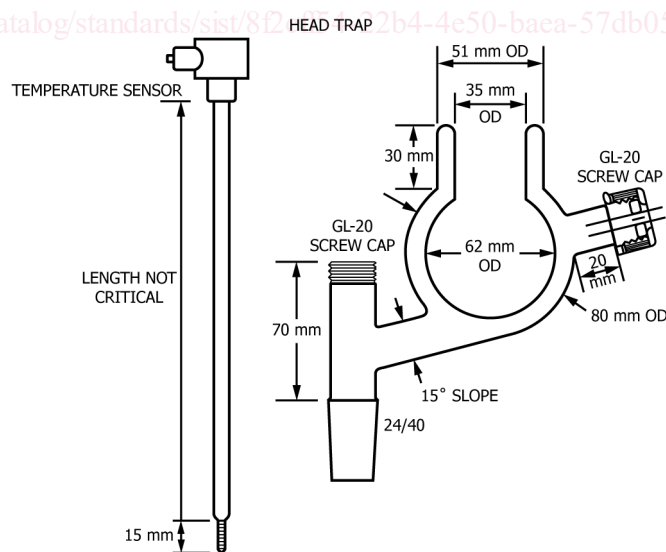
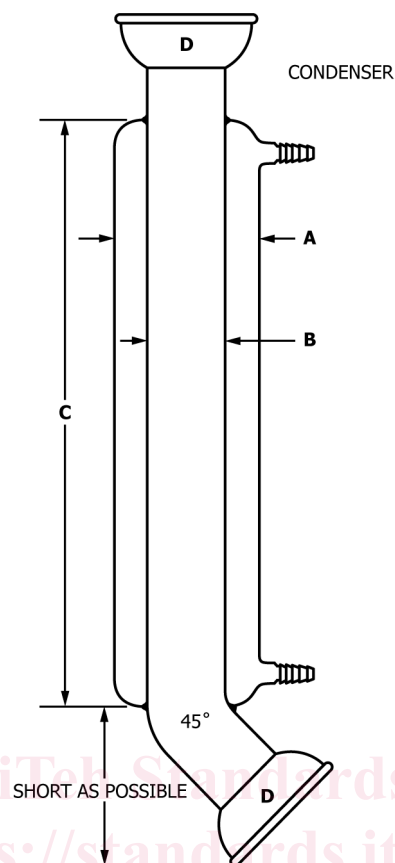

FIG. 4 Head Trap and Temperature Sensor

6.5.6.1 Primary standards, such as the non-tilting McLeod gauge, mercury manometer, or other analogous primary standard pressure devices, can be used without calibration when properly used and maintained. Alternatively, a tensimeter or certified electronic sensors may be used, provided the calibration of the sensor and its associated recording instrument can be traced back to a primary pressure standard.



CONDENSER DIMENSION CHART

System Size	A	B	C	D
25 mm	51 mm	28 mm	300 mm	35/25
36 mm	75 mm	45 mm	300 mm	65/40
50 mm	80 mm	54 mm	400 mm	75/50
70 mm	120 mm	80 mm	400 mm	102/75

FIG. 5 Condenser

6.5.6.2 Noncertified gauges shall be calibrated from a non-tilting McLeod gauge, another primary reference device, or a secondary electronic standard traceable to a primary standard. A basic calibration procedure is described in A2.3. Recalibrate when either the sensor or the instrument is repaired or serviced.

6.5.6.3 Verification of the calibration of pressure sensors is to be made on a regular basis. A frequency of at least once a week is recommended. Verification of the calibration of the sensors can be accomplished using the procedures described in A2.3 or against a certified reference system. (**Warning**—Measurement of vacuum (operating pressure) is one of the two major sources of error in the distillation procedure. It is therefore of prime importance that the instructions on calibration and verification be followed with great care and on a routine basis.)

6.6 *Condenser*—A condenser made of borosilicate glass shall be connected to the outlet arm of the head (see Fig. 5). It shall have sufficient capacity to condense essentially all vapors and capable of operating at coolant temperatures up to 70 °C to prevent wax buildup.

6.7 *Pumping Line:*

6.7.1 A pumping line shall be connected from the outlet of the condenser to the vacuum pump. The pumping line can be made of heavy-walled rubber or light metal tubing, but its inside diameter must be greater than half the inside diameter of the outlet of the condenser and less than 2 m long.

6.7.2 A surge tank of a size at least equal to the capacity of the flask shall be inserted in the pumping line adjacent to the pump.

6.7.3 An isolation valve of a diameter at least equal to the diameter of the pumping line shall be connected between the surge tank and the vacuum pump.

6.7.4 A dewar-type trap made of borosilicate glass, such as that illustrated in Fig. 54, shall be placed between the top of the distillation head and the vacuum sensor. It shall be kept filled with crushed dry ice at all times during the distillation to protect the vacuum system from contamination with residual vapors.

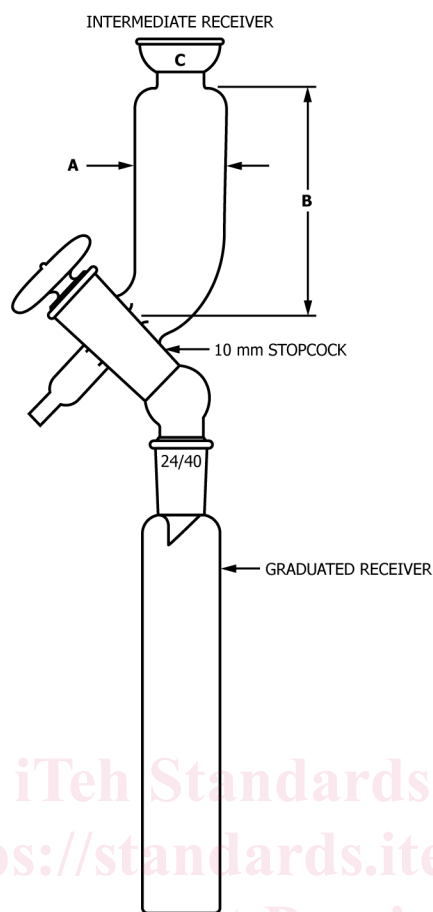

INTERMEDIATE RECEIVER DIMENSION CHART

System Size	A	B	C
25 mm	45 mm	120 mm	35/25
36 mm	51 mm	120 mm	35/25
50 mm	64 mm	150 mm	50/30
70 mm	75 mm	150 mm	50/30

FIG. 6 Receiver System

6.8 *Vacuum Source*—A single-stage mechanical vacuum pump capable of maintaining a steady pressure in the system at all operating pressures shall be connected to the pumping line. Automatic or manual control can be used.

6.9 *Recovery System:*

6.9.1 The recovery system is connected to the lower outlet of the product condenser and consists of a vacuum adapter to permit removal of distillate receivers without disturbing the pressure in the system. A suitable manual device is illustrated in Fig. 6.

6.9.2 Alternatively, either automatic or manual devices can be used to collect part or all of the fractions within the system without disturbing the operating pressure until the end of the run. Heating must be provided when needed to maintain the product in the liquid state.

6.9.3 The product receivers shall be made of borosilicate glass and large enough for the size of the fractions to be collected. They shall be calibrated to the nearest 1 % from the bottom. (**Warning**—This apparatus operates under high vacuum and high temperature. It is recommended that these stills be kept in an enclosure to ensure that in case of an implosion, the operator and others nearby are protected from flying debris, but that the front, at least, be transparent and removable for access to controls and so forth. Automated stills, which are left unattended for long periods, should be equipped with an automatic fire extinguisher, automatic quench, and alarm.)

7. **Sampling**

7.1 Obtain the sample for distillation in accordance with instructions given in Practice D4057 or Practice D4177. The sample can also be a residue from Test Method D2892.

7.2 The sample must be in a closed container when received and show no evidence of leakage.



**TABLE 2 Operating Pressures and Distillation Rates**

Operating Pressure, kPa (mm Hg)	Boil-Up Rate, mL/(h·x·cm <sup>2</sup> )	Take-Off Rate, mL/h			
		25 mm	36 mm	50 mm	70 mm
6.67 (50)	90–150	450–750	900–1500	1800–3000	3600–6000
1.33 (10)	75–125	375–625	750–1250	1500–2500	3000–5000
0.133 (1)	45–75	225–375	450–750	900–1500	1800–3000
0.0400 (0.3)	30–50	150–250	300–500	600–1000	1200–2000
0.0133 (0.1)	10–20	50–100	100–200	200–400	400–800

7.3 If the sample looks waxy or has solidified, warm it enough to liquefy it and ensure that it is thoroughly mixed before using.

7.4 If, upon examination, there is evidence of water in the sample, perform a preliminary distillation as described in [Annex A3](#).

## 8. Preparation of Apparatus

8.1 Clean and dry all glass parts and assemble them with freshly lubricated joints as shown in [Fig. 2](#). In the case of ball joints, use only enough lubricant to produce a thin continuous film. An excess of lubricant can promote leakage. The rings of O-ring joints should be made of Vitron-A,<sup>5</sup> or silicone of equivalent hardness, and be lightly lubricated.

8.2 Tare the receivers to the nearest 0.1 % of the weight of the charge.

8.3 To check for leaks, pump the system down to a pressure of approximately 0.05 kPa (0.4 mm Hg) and isolate it from the vacuum source. If, after 1 min, the rise in pressure is no greater than 0.01 kPa (0.075 mm Hg), the system is acceptable. If the rise in pressure is greater than 0.01 kPa (0.075 mm Hg) in 1 min, the gauge and its connections must be examined and leaks corrected before proceeding.

8.4 Calibrate the temperature and pressure sensors as described in [Annex A2](#).

## 9. Procedure

9.1 Determine the density of the sample by one of the following test methods: Test Method [D941](#), [D1217](#), [D1480](#), [D5002](#), or [D1298](#). Refer to Guide [D1250](#) to correct densities to 15 °C.

9.2 Insert the stirring bar.

9.3 From [Table 1](#), determine the volume of the charge and calculate the mass to be charged by multiplying its density by the desired volume.

9.4 Weigh this mass of charge into the flask to the nearest 0.1 %. In the case of flasks too large to handle, the flask can be put in place and the charge drawn in from a container (weighed with its transfer line) using a pressure of 90 kPa to 95 kPa in the still. The charge may need to be warmed to facilitate transfer. Its mass can be determined from the difference.

9.5 Attach the flask to the column (in the case of smaller flasks), and put on all the heating mantles. Put the stirring device in place and turn it on. (**Warning**—Ensure that the safety shield is in place.)

9.6 A contiguous cutting scheme may be achieved in one of two ways, while remaining within the scope of the key aspects of this method. It may be achieved by gradually reducing the pressure over the course of the distillation (dynamic) or done stepwise, by slowing (or stopping) the takeoff rate to allow lowering of the operating pressure to achieve the final cut temperature. In each case, this must be done keeping in mind the necessity to avoid starving the distillation (due to a slow takeoff rate), while at the same time avoiding entrainment (by reducing too quickly the pressure applied to the system).

9.7 Apply heat to the flask at a rate that will raise the temperature of the charge quickly, but no faster than 300 °C/h (540 °F/h). Do not exceed a skin temperature on the flask of 400 °C (750 °F) or cracking may result on the walls of the flask. (**Warning**—Some hydrocarbon mixtures cannot tolerate 400 °C for any useful length of time. Reducing the skin temperature may be necessary in these cases.)

9.8 Turn on the head compensation mantle and maintain the outer wall of the glass vacuum jacket at a temperature approximately 40 °C below the temperature of the liquid in the flask.

9.9 Reduce the pressure in the system gradually to a suitable starting pressure. Choose from [Table 2](#) the highest pressure that is consistent with the expected initial boiling point as well as the lowest pressure that is consistent with the maximum cutpoint, using [Fig. 7](#) as a guide. A pressure of 0.133 kPa (1.0 mm Hg) has been found satisfactory for starting a material having an initial boiling point of 343 °C (650 °F) AET, such as residues from Test Method [D2892](#) distillations.

NOTE 2—Degassing of the charge is sometimes evident before the actual distillation begins. This appears as bubbling at the surface without generation of condensable vapors.

<sup>5</sup> Vitron A is a registered trademark of DuPont E.I. De Nemours and Co., Wilmington, DE 19898.

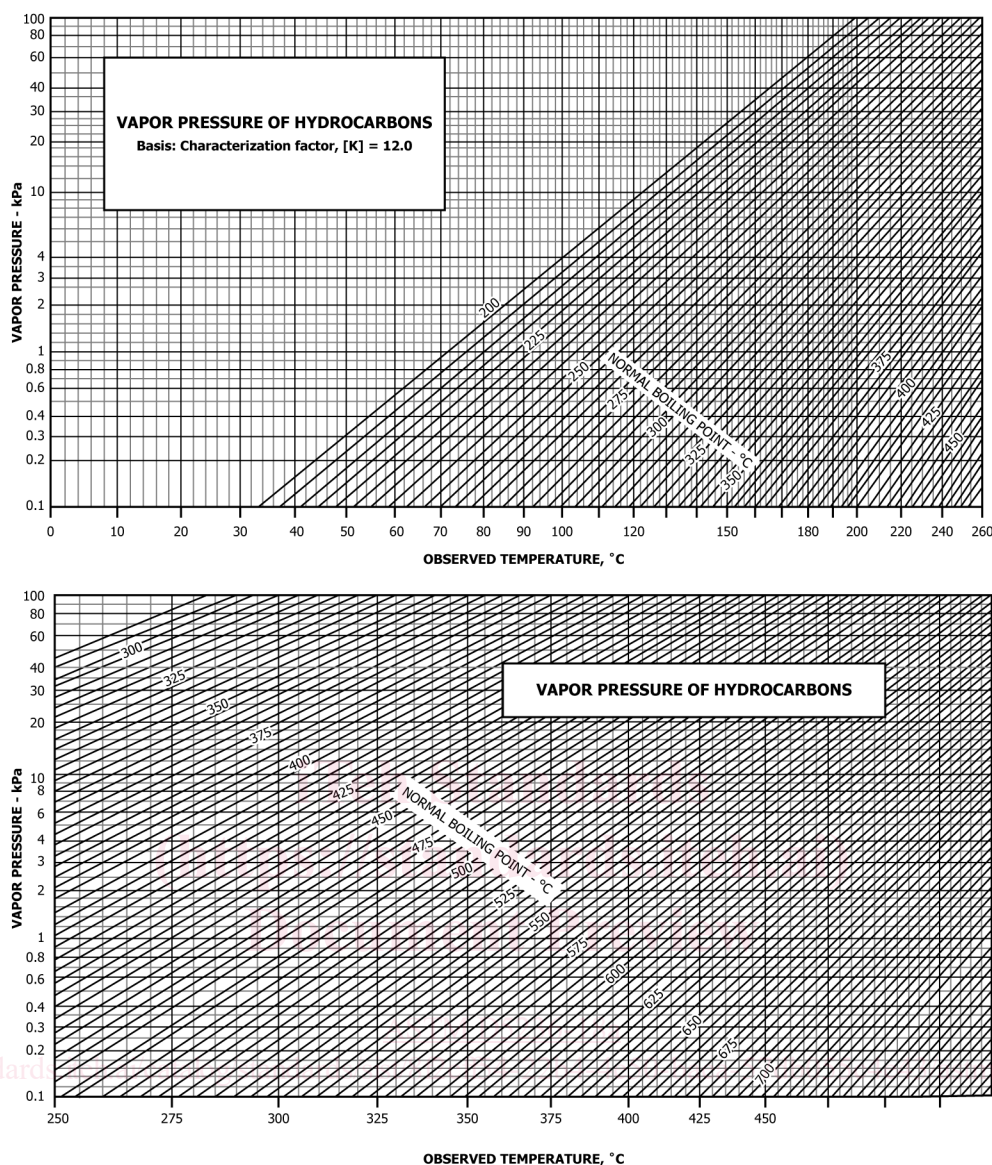

9.10 When distillation begins, evidenced by vapors entering the neck of the flask, reduce the heat input to a level that will maintain the chosen distillation rate from Table 2 (see Note 2). Adjust the heat compensator on the head to maintain the outer wall of the glass vacuum jacket at a temperature 5 °C below the vapor temperature.

NOTE 3—Although a range of distillation rates is permitted, 80 % of the maximum allowed is recommended.

9.11 In cases in which the observed initial vapor temperature will be 150 °C (302 °F) or lower, it is desirable to refrigerate the first fraction receiver to ensure the retention of light ends. If solid, waxy material appears on the walls, warm the receiver with an infrared heat lamp or hot air gun to liquify the product in the receiver in order to improve the accuracy of the reading. In automatic operation, the receivers must be thermostated at a temperature high enough to ensure that no solidification takes place and low enough to prevent evaporation of light material.

9.12 When using the dynamic method of pressure reduction, calculate a projected final cutpoint using the operating pressure and the differential between the vapor and pot temperature as the operating envelope. Estimating that the difference between the vapor and the pot temperature remain relatively constant, determine if the final vapor temperature can be achieved at this pressure while remaining within the recommended limitations of the flask temperature (see 9.18). If the final cutpoint cannot be achieved at the starting pressure, the pressure should be gradually lowered toward an operating pressure that will allow the final cut to be taken. This must be done bearing in mind the associated takeoff rates for the vacuum pressures indicated in Table 2 and the limitations of the pot temperature. The pressure should be lowered enough to allow the takeoff rate to accelerate briefly while the operator is remaining vigilant to avoid entrainment. The distillation rate at the operating pressure should fall within the