



Standard Specification for 3.25-in. Outside Diameter Poly(Vinyl Chloride) (PVC) Plastic Drain, Waste, and Vent Pipe and Fittings¹

This standard is issued under the fixed designation D2949; the number immediately following the designation indicates the year of original adoption or, in the case of revision, the year of last revision. A number in parentheses indicates the year of last reapproval. A superscript epsilon (ϵ) indicates an editorial change since the last revision or reapproval.

1. Scope*

1.1 This specification covers requirements and test methods for materials, dimensions and tolerances, deflection load, crush resistance, flattening resistance, impact resistance, and solvent cement. A form of marking is also included. Plastic which does not meet the material requirements specified in Section 5 is excluded.

NOTE 1—This specification was formerly issued under the title, 3-in. Thin Wall Poly(Vinyl Chloride) (PVC) Plastic Drain, Waste, and Vent Pipe and Fittings.

NOTE 2—Techniques for making solvent-cement joints are given in Practice ~~D2855~~.

1.1.1 Techniques for making solvent-cement joints are given in Practice ~~D2855~~.

1.2 The text of this specification references notes, footnotes, and appendixes which provide explanatory material. These notes and footnotes (excluding those in tables and figures) shall not be considered as requirements of the specification.

1.3 The values stated in inch-pound units are to be regarded as standard. The values given in parentheses are mathematical conversions to SI units that are provided for information only and are not considered standard.

1.4 The following precautionary caveat pertains only to the test methods portion, Section 7, of this specification: *This standard does not purport to address all of the safety concerns, if any, associated with its use. It is the responsibility of the user of this standard to establish appropriate safety, health, and environmental practices and determine the applicability of regulatory limitations prior to use.*

1.5 *This international standard was developed in accordance with internationally recognized principles on standardization established in the Decision on Principles for the Development of International Standards, Guides and Recommendations issued by the World Trade Organization Technical Barriers to Trade (TBT) Committee.*

2. Referenced Documents

2.1 ASTM Standards:²

D618 Practice for Conditioning Plastics for Testing

D1600 Terminology for Abbreviated Terms Relating to Plastics

D1784 Specification for Rigid Poly(Vinyl Chloride) (PVC) Compounds and Chlorinated Poly(Vinyl Chloride) (CPVC) Compounds

D2122 Test Method for Determining Dimensions of Thermoplastic Pipe and Fittings

D2152 Test Method for Adequacy of Fusion of Extruded Poly(Vinyl Chloride) (PVC) Pipe and Molded Fittings by Acetone Immersion

D2412 Test Method for Determination of External Loading Characteristics of Plastic Pipe by Parallel-Plate Loading

D2444 Practice for Determination of the Impact Resistance of Thermoplastic Pipe and Fittings by Means of a Tup (Falling Weight)

D2564 Specification for Solvent Cements for Poly(Vinyl Chloride) (PVC) Plastic Piping Systems

D2855 Practice for the Two-Step (Primer and Solvent Cement) Method of Joining Poly (Vinyl Chloride) (PVC) or Chlorinated Poly (Vinyl Chloride) (CPVC) Pipe and Piping Components with Tapered Sockets

D3311 Specification for Drain, Waste, and Vent (DWV) Plastic Fittings Patterns

¹ This specification is under the jurisdiction of ASTM Committee F17 on Plastic Piping Systems and is the direct responsibility of Subcommittee F17.63 on DWV. Current edition approved Nov. 15, 2010; Nov. 1, 2018, Published January 2011; January 2019. Originally approved in 1971. Last previous edition approved in 2008 as ~~D2949 – 01a~~ (2008) ~~D2949 – 10~~. DOI: ~~10.1520/D2949-10~~; 10.1520/D2949-18.

² For referenced ASTM standards, visit the ASTM website, www.astm.org, or contact ASTM Customer Service at service@astm.org. For Annual Book of ASTM Standards volume information, refer to the standard's Document Summary page on the ASTM website.

*A Summary of Changes section appears at the end of this standard

F402 Practice for Safe Handling of Solvent Cements, Primers, and Cleaners Used for Joining Thermoplastic Pipe and Fittings
 F412 Terminology Relating to Plastic Piping Systems
 F1498 Specification for Taper Pipe Threads 60° for Thermoplastic Pipe and Fittings

3. Terminology

3.1 *Definitions*—Definitions are in accordance with Terminology F412, and abbreviations are in accordance with Terminology D1600, unless otherwise specified.

4. Significance and Use

4.1 The requirements of this specification are intended to provide pipe and fittings suitable for drainage of sewage and certain other liquid wastes where toughness, resistance to deterioration from water and chemicals, flattening and aging resistance, and strong tight joints are required.

NOTE 2—Industrial waste disposal lines should be installed only with the specific approval of the cognizant building code authority since chemicals not commonly found in drains and sewers, and temperatures in excess of 160°F (70°C), may be encountered.

4.2 When joining 3.25-in. outside diameter PVC DWV piping to 3-in. Schedule 40 PVC DWV piping, it is necessary to use either reducer bushings or increasers, as shown in the tables at the end of the text, due to the differences in pipe outside diameters.

NOTE 3—Industrial waste disposal lines should be installed only with the specific approval of the cognizant building code authority since chemicals not commonly found in drains and sewers, and temperatures in excess of 160°F (70°C), may be encountered.

5. Materials

5.1 *Basic Materials*—Pipe and fittings shall be made from virgin poly (vinyl chloride) compounds meeting the requirements of Class 12454, as defined and described in Specification D1784.

5.2 *Rework Material*—The manufacturer shall use only his own clean pipe or fitting rework material and the pipe or fitting produced shall meet all the requirements of this specification.

5.3 *Solvent Cement*—The solvent cement shall meet the requirements of Specification D2564.

6. Requirements

6.1 *General*—The pipe and fittings shall be homogeneous throughout and free of visible cracks, holes, foreign inclusions, or other injurious defects. The pipe shall be as uniform as commercially practicable in color, opacity, density, and other physical properties.

6.1.1 The requirements in this section are intended only for use as quality control tests, not as simulated service tests.

6.2 *Dimensions and Tolerances*—All dimensions shall be measured in accordance with Test Method D2122. All tolerances shall meet the requirements of Tables 1-11 unless otherwise specified.

6.2.1 *Pipe:*

6.2.1.1 *Pipe Dimensions*—The outside diameters and wall thicknesses of the pipe shall meet the requirements of Table 1.

6.2.1.2 *Pipe Length*—The pipe shall be in either 10 or 20-ft or 3 or 6-m lengths, unless otherwise specified with allowable tolerance of +1/2 in., 0 in. or +13 mm, -0 mm.

6.2.2 *Fittings:*

6.2.2.1 *Fittings-Socket Dimensions*—The socket dimensions of fittings shall meet the requirements given in Table 2.

6.2.2.2 *Fittings Laying Length Dimensions*—The laying length dimensions of fittings, shall conform to the requirements given in Table 3 through Table 11.

6.2.2.3 *Transition Adapters*—The dimensions of adapters for connecting plastic pipe to cast iron hubs shall conform to the dimensions given in Table 4.

6.2.2.4 *Fittings Dimensions*—The dimensions of fittings covered by this specification shall meet the requirements given in Table 3 through Table 11.

NOTE 3—Additional fittings in IPS dimensions are included in Specification D3311.

6.3 *Deflection Load and Crush Resistance:*

TABLE 1 Dimensions and Tolerances for Outside Diameters and Thicknesses of PVC 3.25-in. Outside Diameter Plastic Drain, Waste, and Vent Pipe, in. (mm)

Nominal Pipe Size, in.	Outside Diameter		Wall Thickness ⁴	
	Average	Tolerance on Average	Min	Tolerance
3.25	3.250 (82.56)	±0.008 (±0.20)	0.125 (3.18)	+0.020 (+0.50)

⁴ The minimum is the lowest wall thickness of the pipe at any cross section. The maximum permitted wall thickness, at any cross section, is the minimum wall thickness plus the stated tolerance.

TABLE 2 Dimensions and Tolerances for Fitting Sockets for 3.25-in. Outside Diameter PVC Plastic Drain, Waste, and Vent Pipe Fittings, in. (mm)

NOTE 1—Spigot ends shall conform to the outside diameters and tolerances for pipe of the same size

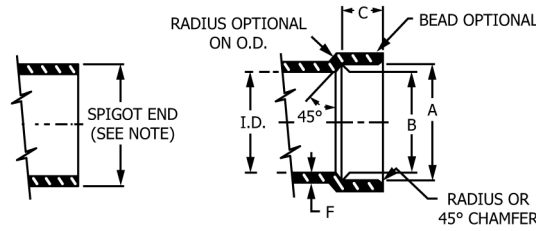

Nominal Pipe Size, in.	A Socket Entrance Diameter		B Socket Bottom Diameter		C Spigot and Socket Depth	D Wall Thickness
	avg ^A	Tm^B	avg ^C	Tm^B	min	min ^{D,E}
3.25	3.265 (82.94)	±0.008 (±0.20)	3.245 (82.42)	±0.008 (±0.20)	1½ (38)	0.140 (3.56)

^A The tolerances on this average are +0.010 to -0.005 in. (+0.25 to -0.13 mm).

^B Tm = permissible deviation of diameter from measured average, often called out-of-roundness.

^C Tolerance on average +0.005 in., -0.010 in. (+0.13 mm, -0.25 mm).

^D Minimum wall thickness in the socket is 0.125 in.

^E The wall thickness is a minimum value except that a ±10 % variation resulting from core shift is allowable. In such a case, the average of the two opposite wall thicknesses shall equal or exceed the value shown in the table.

TABLE 3 3.25-in. Outside Diameter Bends, in. (mm)

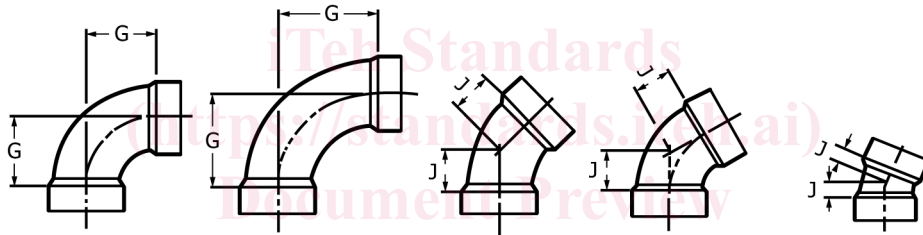

1/4 BEND

**LONG-SWEEP
1/4 BEND**

1/8 BEND

1/6 BEND

1/16 BEND

Nominal Pipe Size, in.	¼ Bend G, min	Long-Sweep ¼ Bend G, min	⅛ Bend J, min	⅙ Bend J, min	⅑ Bend J, min
3.25	2⅞ (73)	4 (101.6)	1 (25.4)	1¼ (31.8)	⅝ (15.88)

6.3.1 *Pipe*—The pipe shall support a minimum load of 600 lbf/linear ft (810 N/m) at 15 % deflection of the original diameter (deflection load), and shall deflect 60 % of the original diameter (crush resistance) without cracking, rupture, or other visible evidence of failure when tested in accordance with 7.4. The minimum pipe stiffness at 5 % deflection shall be 115 lbf/in.·in. (800 kPa).

6.3.2 *Fittings*—Individual fittings unassembled shall withstand a minimum load of 1000 lbf/ft (1350 N/m) of centerline length without cracking or other visible evidence of failure when tested in accordance with 7.4. This requirement does not apply to inline fittings.

6.4 *Flattening Resistance*—The average decrease in inside diameters of pipe and fittings shall not exceed 10 % when tested in accordance with 7.5 (Note 32).

6.5 *Impact Resistance*—The minimum impact resistance, when tested at the time of manufacture, shall be 50 ft·lbf (67.79 J) at 73°F (23°C) for pipe and 20 ft·lbf (27.12 J) at 73°F (23°C) for fittings. Test in accordance with Test Method D2444 using Tup C and Holder A for pipe and Tup A and Holder B for fittings. Use a 12-lb (5-kg) tup for testing pipe and fittings. Test couplings cemented to short pieces of pipe and allowed to dry for 24 h.

6.5.1 Test 10 specimens. When 9 or 10 specimens pass, accept the lot. When 2 or more specimens fail, test 10 additional specimens. When 17 of 20 specimens tested pass, accept the lot. When 4 or more of 20 specimens fail, test 20 additional specimens. When 32 of 40 specimens pass, accept the lot. When 9 or more of 40 specimens fail, the lot does not meet the requirements of this specification.

TABLE 4 3.25-in. Outside Diameter Reducing Spigots, in. (mm)

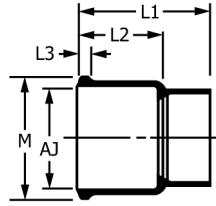

PLASTIC SPIGOT, Reducing Adapts Cast Iron Hub to Plastic Pipe

Nominal Pipe Size, in.	L_2 , min	L_1 , min	L_3 , min	M		AJ, Nominal
				max	min	
3.25 by 4-in. Cast Iron	$3\frac{7}{8}$ (98.4)	$5\frac{5}{8}$ (142.9)	$\frac{3}{8}$ (9.5)	$4\frac{9}{16}$ (115.9)	$4\frac{1}{2}$ (114.3)	$3\frac{7}{8}$ (98.4)

TABLE 5 3.25-in. Outside Diameter Reducing Sanitary Tee and 45° Wyes, in. (mm)

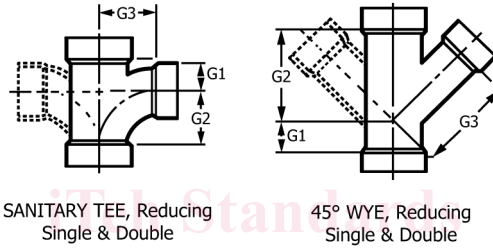

SANITARY TEE, Reducing Single & Double

45° WYE, Reducing Single & Double

Nominal Pipe Size, in.	Sanitary Tee Reducing			45° Wye Reducing Single and Double		
	G_1 , min	G_2 , min	G_3 , min	G_1 , min	G_2 , min	G_3 , min
3.25 by 3.25 by 1½-in. IPS	$1\frac{5}{16}$ (23.8)	$1\frac{3}{4}$ (44.5)	$2\frac{3}{16}$ (55.6)	$\frac{3}{8}$ (9.5)	$3\frac{1}{4}$ (82.5)	$3\frac{17}{32}$ (89.7)
3.25 by 3.25 by 2-in. IPS	$1\frac{3}{8}$ (34.9)	2 (50.8)	$2\frac{1}{4}$ (57.2)	$\frac{3}{8}$ (9.5)	$3\frac{1}{4}$ (82.5)	$3\frac{11}{16}$ (93.6)

TABLE 6 3.25-in. Outside Diameter Bushings in. (mm)

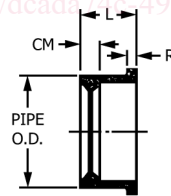

BUSHING Style 1

Nominal Pipe Size, in.	Style 1		
	L , min	CM, min	R , min
3.25 by 1½-in. IPS	$1\frac{7}{8}$ (47.6)	$1\frac{1}{8}$ (28.6)	$\frac{3}{8}$ (9.5)
3.25 by 2-in. IPS	$1\frac{7}{8}$ (47.6)	1 (25.4)	$\frac{3}{8}$ (9.5)
3.25 by 3-in. IPS	$1\frac{3}{4}$ (44.5)	$\frac{1}{4}$ (6.4)	0 (0)

6.5.2 Failure of the test specimen shall be shattering or any crack or break extending entirely through the pipe wall and visible to the unaided eye.

6.6 *Threads*—For all fittings having taper pipe threads, threads shall conform to Specification F1498 and be gaged in accordance with 7.6.

6.7 *Extrusion Quality*—The pipe shall not flake or disintegrate when tested in accordance with Test Method D2152.

TABLE 7 4-in. by 3.25-in. Outside Diameter Reducing Closet Ring

NOTE 1—Slot is optional if fully reinforced with a corrosion-resistant material.

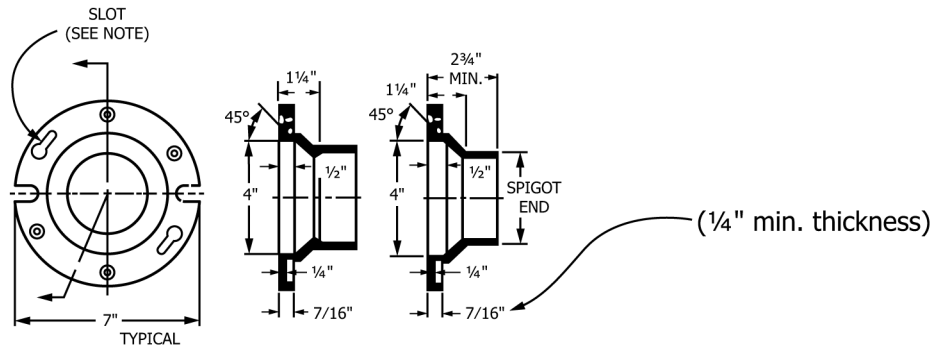

4" x 3" REDUCING CLOSET RING

Closet Flange, in. (mm) ^A	
in.	mm
7	(180)
4	(101.5)
2 3/4	(70)
1 1/4	(32)
1/2	(13)
7/16	(11)
1/4	(6.5)

^A Tolerance $\pm 1/16$ in. or ± 1.6 mm.

TABLE 8 3.25-in. Outside Diameter Sanitary Tees—45° Wyes, in. (mm)

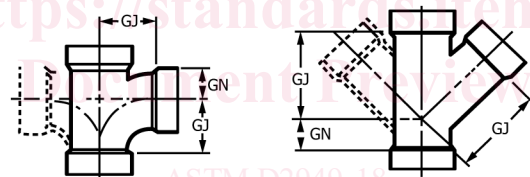

SANITARY TEE Single & Double 45° WYE Single & Double

Nominal Pipe Size, in.	Sanitary Tee Single and Double, min		45° Wye Single and Double, min	
	GN	GJ	GN	GJ
3.25	1 1/16 (36.5)	2 15/16 (74.6)	3/4 (19.0)	4 1/8 (104.8)

7. Test Methods

7.1 *Sampling*—Take a random sample from each lot or shipment of the pipe and fittings sufficient to determine conformance with this specification. About 40 ft (12 m) of pipe are required to make the tests prescribed. The number of fittings required varies depending on the size and type of fitting.

7.2 *Conditioning:*

7.2.1 For referee testing at 73°F, condition the specimens prior to test at $73.4 \pm 3.6^{\circ}\text{F}$ ($23 \pm 2^{\circ}\text{C}$) and $50 \pm 5\%$ relative humidity in accordance with Practice D618, Procedure A.

7.2.2 For routine quality control testing at 73°F, condition the specimens at the temperature and humidity of the manufacturers testing facility for not less than 1 h or until the specimens are at the room temperature.

7.3 *Test Conditions:*

7.3.1 For referee purposes, conduct tests in the standard laboratory atmosphere of $73.4 \pm 3.6^{\circ}\text{F}$ ($23 \pm 2^{\circ}\text{C}$) and $50 \pm 5\%$ relative humidity.

7.3.2 For routine quality control testing, conduct tests at the temperature and humidity of the manufacturers testing area.

7.4 *Deflection Load and Crush Resistance*—Measure the deflection load and crush resistance of pipe and fittings in accordance with Test Method D2412. In the test for pipe note the load when the initial inside diameter is reduced by 5 % (pipe stiffness), by

TABLE 9 3.25-in. Outside Diameter Couplings and Adapter, in. (mm)

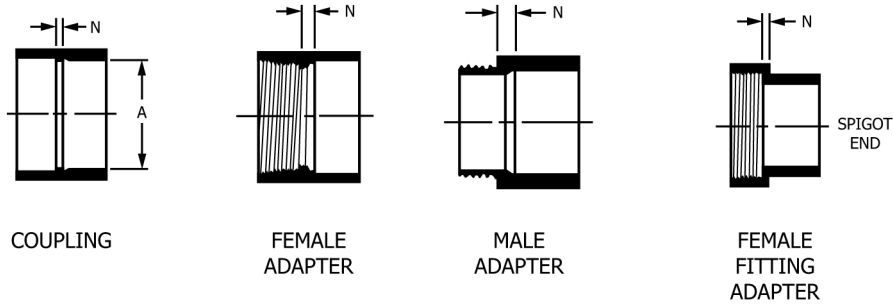

Nominal Pipe Size, in.	Coupling <i>N</i> , min	Female Adapter <i>N</i> , min	Male Adapter <i>N</i> , min	Female Fitting Adapter <i>N</i> , min
3.25	3/16 (4.8)	7/16 (11.1)	5/16 (7.9)	1/8 (3.2)

TABLE 10 3.25-in. Outside Diameter Pipe Increases, in. (mm)

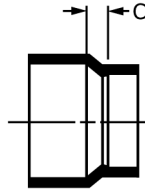

PIPE INCREASER

Nominal Pipe Size, in.	<i>C</i> , min
3.25 by 1½-in. IPS	½ (12.7)
3.25 by 2-in. IPS	3/8 (9.5)
3.25 by 3-in. IPS	¾ (19.0)

TABLE 11 3.25-in. Outside Diameter Bends with Inlets, in. (mm)

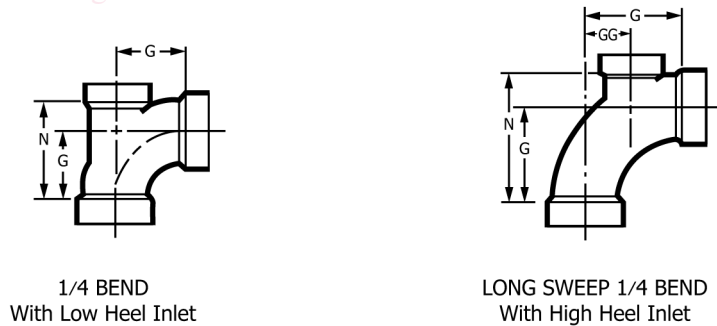

Nominal Pipe Size, in.	¼ Bend with Low Heel Inlet, min		Long-Sweep ¼ Bend with High Heel Inlet, min		
	<i>G</i>	<i>N</i>	<i>G</i>	<i>N</i>	<i>GG</i>
3.25 by 1¼-in. IPS	2 7/8 (73.0)	4 (102)	4 (102)	5 1/16 (144.5)	2 ½ (63.5)
3.25 by 2-in. IPS	2 7/8 (73.0)	4 1/8 (104.8)			

15 % (deflection load), and continue the test until the diameter is reduced by 60 % of its original value (crush resistance). The rate of head approach shall be 0.20 to 0.25 in./min (5.1 to 6.4 mm/min). Each specimen shall meet the requirements of 6.3.1.

7.4.1 *Fitting Test Specimens*—Test three complete fittings. Shim fittings to give full centerline contact with platens. Fittings having nonuniform diameters such as reducers shall be considered acceptable when the wall thickness at all points is equal to or greater than the wall thickness of pipe of the same material and diameter that meets the crush resistance requirements. Each specimen shall meet the requirements of 6.3.2.