



Designation: **C840 – 18b C840 – 19**

Standard Specification for Application and Finishing of Gypsum Board¹

This standard is issued under the fixed designation C840; the number immediately following the designation indicates the year of original adoption or, in the case of revision, the year of last revision. A number in parentheses indicates the year of last reappraisal. A superscript epsilon (ϵ) indicates an editorial change since the last revision or reappraisal.

This standard has been approved for use by agencies of the U.S. Department of Defense.

1. Scope*

1.1 This specification covers the minimum requirements for the methods of application and finishing of gypsum board, including related items and accessories.

1.2 Details of construction for a specific assembly to achieve the required fire resistance shall be obtained from reports of fire-resistance tests, engineering evaluations, or listings from recognized fire testing laboratories.

1.2.1 Where this specification is more stringent (size or thickness of framing; size and spacing of fasteners) than the fire-rated construction, this specification shall govern.

1.3 Where sound control is required for a gypsum board assembly, details of construction shall be in accordance with reports of acoustical tests of assemblies that have met the required acoustical values.

1.4 Unheated spaces above gypsum board ceilings shall be properly ventilated (see [Appendix X2](#)).

1.5 The various application systems are located in the following sections:

I	Application of Single-ply Gypsum Board to Wood Framing Members	8
II	Application of Two-ply Gypsum Board to Wood Framing Members	9
III	Application of Gypsum Board by Adhesive Nail-on to Wood Framing Members	10
IV	Semi-solid Gypsum Board Partitions	11
V	Solid Gypsum Board Partitions	12
VI	Application of Gypsum Board with Adhesives to Interior Masonry or Concrete Walls	13
VII	Application of Gypsum Board to Rigid Foam Insulation	14
VIII	Application of Gypsum Board to Steel Framing and Furring	15
IX	Arches and Bending Radii	16
X	Application of Gypsum Board to Receive Tile by Adhesive Application	17
XI	Exterior Application of Gypsum Wallboard and Exterior Gypsum Soffit Board	18
XII	Floating Interior Angles	19
XIII	Control (Expansion) Joints	20
XIV	Foil-backed Gypsum Board	21
XV	Application of Vinyl Faced Gypsum Board	22

1.6 The values stated in inch-pound units are to be regarded as standard. The values given in parentheses are mathematical conversions to SI units that are provided for information only and are not considered standard.

1.7 The text of this specification references notes and footnotes which provide explanatory material. These notes and footnotes (excluding those in tables and figures) shall not be considered as requirements of the specification.

1.8 The following precautionary caveat pertains only to Sections 6 – 26. *This standard does not purport to address all of the safety concerns, if any, associated with its use. It is the responsibility of the user of this standard to establish appropriate safety, health, and environmental practices and determine the applicability of regulatory limitations prior to use. For specific precautionary statements, see 4.1.1, 4.1.2, and 24.5.*

1.9 *This international standard was developed in accordance with internationally recognized principles on standardization established in the Decision on Principles for the Development of International Standards, Guides and Recommendations issued by the World Trade Organization Technical Barriers to Trade (TBT) Committee.*

¹ This specification is under the jurisdiction of ASTM Committee C11 on Gypsum and Related Building Materials and Systems and is the direct responsibility of Subcommittee C11.03 on Specifications for the Application of Gypsum and Other Products in Assemblies.

Current edition approved Nov. 15, 2018 June 1, 2019. Published November 2018 June 2019. Originally approved in 1979. Last previous edition approved in 2018 as C840 – 18a, C840 – 18b. DOI: 10.1520/C0840-18B-10.1520/C0840-19.

*A Summary of Changes section appears at the end of this standard

2. Referenced Documents

2.1 ASTM Standards:²

- [C11 Terminology Relating to Gypsum and Related Building Materials and Systems](#)
- [C475/C475M Specification for Joint Compound and Joint Tape for Finishing Gypsum Board](#)
- [C514 Specification for Nails for the Application of Gypsum Board](#)
- [C557 Specification for Adhesives for Fastening Gypsum Wallboard to Wood Framing](#)
- [C645 Specification for Nonstructural Steel Framing Members](#)
- [C754 Specification for Installation of Steel Framing Members to Receive Screw-Attached Gypsum Panel Products](#)
- [C920 Specification for Elastomeric Joint Sealants](#)
- [C954 Specification for Steel Drill Screws for the Application of Gypsum Panel Products or Metal Plaster Bases to Steel Studs from 0.033 in. \(0.84 mm\) to 0.112 in. \(2.84 mm\) in Thickness](#)
- [C955 Specification for Cold-Formed Steel Structural Framing Members](#)
- [C1002 Specification for Steel Self-Piercing Tapping Screws for Application of Gypsum Panel Products or Metal Plaster Bases to Wood Studs or Steel Studs](#)
- [C1007 Specification for Installation of Load Bearing \(Transverse and Axial\) Steel Studs and Related Accessories](#)
- [C1047 Specification for Accessories for Gypsum Wallboard and Gypsum Veneer Base](#)
- [C1396/C1396M Specification for Gypsum Board](#)
- [C1546 Guide for Installation of Gypsum Products in Concealed Radiant Ceiling Heating Systems](#)
- [E2634 Specification for Flat Wall Insulating Concrete Form \(ICF\) Systems](#)

2.2 U.S. Department of Commerce Publication:

- [PS20 American Softwood Lumber Standard³](#)

2.3 ANSI Standard:⁴

- [ANSI A108 Specifications for the Installation of Ceramic Tile](#)
- [ANSI A136.1 Specifications for Organic Adhesives for Installation of Ceramic Tile, Type I and Type II](#)

3. Terminology

3.1 *Definitions*—Definitions shall be in accordance with Terminology [C11](#).

3.2 *Definitions of Terms Specific to This Standard:*

- 3.2.1 *critical lighting, n*—a condition where interior surfaces are flooded by natural or artificial lighting at an oblique angle.
- 3.2.2 *decoration, n*—paint (including primers), texture, coatings, and coverings such as wallpaper and sheet plastic materials designed to conceal or protect the surface of the gypsum board (see [Appendix X3](#)).
- 3.2.3 *dry type, n*—a compound in powder form to be mixed with water before use.
- 3.2.4 *drying type, n*—a compound that hardens by the evaporation of the vehicle used to make the paste.
- 3.2.5 *drywall primer, n*—a paint material specifically formulated to fill the pores and minimize the suction difference between gypsum board surface paper and the compound used on finished joints, angles, fastener heads and accessories, and over skim coatings.
- 3.2.6 *face panel, n*—outside ply of multiple layer gypsum board assemblies.
- 3.2.7 *finished wallboard, n*—wallboard that has had the joints taped, has had the joints, fastener heads, and flanges of accessories concealed with joint compound, and has been sanded to prepare the surface to receive job applied decoration.
- 3.2.8 *finishing, n*—the preparation of gypsum board surfaces to receive the field application of decoration.
- 3.2.9 *finishing of accessories, n*—the application of compound to flanges of accessories to create a monolithic surface.
- 3.2.10 *flange, n*—that part of an accessory extending over the face of the gypsum wallboard intended to become a part of the monolithic plane of the prepared surface.
- 3.2.11 *harden, v*—a condition reached when the compound has lost its plasticity to an arbitrary degree, measured in resistance to penetration or deformation.
- 3.2.12 *joint photographing, n*—a condition where the finished joint areas visible after final decoration.
- 3.2.13 *joint treatment, n*—application of joint tape and compound to the joint between gypsum boards.
- 3.2.14 *laminating compound, n*—a compound (abrasive) used to adhere gypsum board to gypsum board or other monolithic materials.

² For referenced ASTM standards, visit the ASTM website, www.astm.org, or contact ASTM Customer Service at service@astm.org. For *Annual Book of ASTM Standards* volume information, refer to the standard's Document Summary page on the ASTM website.

³ Available from U.S. Government Printing Office, Washington, DC 20402.

⁴ Available from American National Standards Institute (ANSI), 25 W. 43rd St., 4th Floor, New York, NY 10036, <http://www.ansi.org>.

3.2.15 *moderate contact, n*—the edges and ends are butted at joints but not forced together.

3.2.15.1 *Discussion*—

Small gaps not greater than ¼ in. (6 mm) are acceptable (see 7.4).

3.2.16 *parallel or vertical application, n*—gypsum board applied with the edges parallel to the framing member to which it is attached.

3.2.17 *perpendicular or horizontal application, n*—gypsum board application with the edges applied at right angles to the framing member to which it is attached.

3.2.18 *ready-mix type, n*—a factory-prepared compound ready to be used without the addition of water.

3.2.19 *required, adj*—pertaining to a mandatory obligation imposed by a force outside this standard, such as a building code, project specification, contract, or purchase order.

3.2.20 *setting type, n*—a compound that hardens by a chemical reaction and increases in strength through drying.

3.2.21 *skim coat, n*—a thin layer of skim coat compound applied over the entire surface of finished gypsum board.

3.2.21.1 *Discussion*—

A skim coat is essentially a film of joint compound and is not applied at a readily measurable thickness. There is no specific mil thickness that constitutes a proper skim coat (see Appendix X7).

3.2.22 *skim coat compound, n*—joint compound, or a material specifically formulated and manufactured for use as a skim coat.

3.2.23 *specified, adj*—pertaining to a mandatory requirement of this standard or a referenced requirement (see 3.2.17).

3.2.24 *spotting fastener heads, n*—the application of compound to cover the fastener head to create a monolithic surface.

3.2.25 *taping of joints, n*—the application of compound and joint reinforcing tape to the joints between adjoining gypsum boards.

3.2.26 *treated joint, n*—a joint between gypsum boards that has been covered with joint tape and joint compound as specified in 24.3.3.1, 24.3.3.2, or 24.3.3.3.

3.2.26.1 *Discussion*—Strip moldings or similar devices shall be permitted.

4. Environmental Conditions

4.1 *Application of Gypsum Board, Joint Treatment Materials, and Adhesives*—Room temperature shall be maintained at not less than 40°F (4°C) during application of gypsum board except when adhesive is used for the attachment of gypsum board. For the bonding of adhesive, joint treatment, texturing, and decoration, the room temperature shall be maintained at not less than 50°F (10°C) for 48 h prior to application and continuously thereafter until completely dry. See X7.7 for additional detail regarding environmental control during the installation and finishing process.

4.1.1 When a temporary heat source is used, the temperature shall not exceed 95°F (35°C) in any given room or area.

4.1.2 Adequate ventilation shall be maintained in the working area during installation and curing period.

4.2 Gypsum board shall be protected from direct exposure to rain, snow, sunlight, or other excessive weather conditions.

NOTE 1—Where manufacturers' recommendations differ from the above, follow their recommendations.

4.3 Ready-mixed joint compounds shall be protected from freezing, exposure to extreme heat, and direct sunlight.

5. Materials and Manufacture

5.1 *Gypsum Boards*—A family of gypsum sheet products as defined in Terminology C11.

5.1.1 *Type X (Special Fire-resistant) Gypsum Wallboard, Gypsum Backing Board, Water-resistant Gypsum Backing Board, or Exterior Gypsum Soffit Board*—Gypsum board that provides a greater degree of fire resistance than regular gypsum board as defined in Specification C1396/C1396M.

5.1.2 *Foil-backed Gypsum Wallboard or Gypsum Backing Board*—Regular or Type X gypsum board with foil laminated to the back surface. The foil is a vapor retarder.

5.1.3 *Predecorated Gypsum Board*—Gypsum board with a decorative wall covering or coating applied in-plant by the gypsum board manufacturer.

5.2 *Gypsum Wallboard*—See Specification C1396/C1396M.

5.3 *Gypsum Backing Board and Coreboard*—See Specification C1396/C1396M.

5.4 *Water-resistant Gypsum Backing Board*—See Specification C1396/C1396M.

5.5 *Exterior Gypsum Soffit Board*—See Specification **C1396/C1396M**.

5.6 *Gypsum Ceiling Board*—See Specification **C1396/C1396M**.

5.7 *Finishing Materials:*

5.7.1 *Compounds*—Taping compound, finishing compound, and all-purpose compound shall meet the requirements of Specification **C475/C475M**.

5.7.2 Mix compounds in accordance with the manufacturers' directions.

5.7.3 *Joint Tape*—See Specification **C475/C475M**.

5.8 *Fasteners:*

5.8.1 *Nails*—See Specification **C514**.

5.8.1.1 Nails for use with pressure treated lumber shall be compatible with the preservative treated and fire retardant treated lumber.

5.8.2 *Screws:*

5.8.2.1 See Specification **C1002** for screws for fastening gypsum board to wood members, steel members less than 0.033 in. (0.84 mm) in thickness, and to gypsum board.

5.8.2.2 See Specifications **C754** and **C954** for screws for fastening gypsum board to steel members from 0.033 to 0.112 in. (0.84 to 2.84 mm) in thickness.

5.8.2.3 Screws for use with pressure treated lumber shall be compatible with the preservative treated and fire retardant treated lumber.

5.8.3 *Staples*—No. 16 USS gauge flattened galvanized wire staples with $\frac{7}{16}$ in. (11 mm) wide crown outside measurement. Legs shall have divergent points.

NOTE 2—Use only for the base ply of two-ply gypsum board application.

5.8.3.1 Staples for use with pressure treated lumber shall be compatible with the preservative treated and fire retardant treated lumber.

5.9 *Adhesives:*

5.9.1 *Fastening Gypsum Board to Wood Framing*—See Specification **C557**.

5.9.2 *Fastening Gypsum Board to Steel Framing*—As specified by the manufacturer.

5.9.3 *Laminating Gypsum Board to Gypsum Board*—Laminating compounds, taping compound, or adhesive shall be as specified by the manufacturer.

5.10 *Framing Members:*

5.10.1 Wood framing members shall conform to PS20, American Softwood Lumber Standards. The surface to which abutting edges or ends are attached shall be not less than $1\frac{1}{2}$ in. (38 mm) wide. For internal corners or angles, the bearing surface shall not be less than $\frac{3}{4}$ in. (19 mm).

5.10.2 *Steel Studs, Furring Channels, and Runners*:
~~Runners:~~

5.10.2.1 Non-load-bearing (see Specification **C645**).

5.10.2.2 Load-bearing (see Specification **C955**.)

5.10.3 *Gypsum Studs*—Specification **C1396/C1396M**, not less than 1 in. (25 mm) thick by 6 in. (150 mm) wide. Studs shall be either solid or laminated.

5.11 *Accessories*—See Specification **C1047**.

5.12 *Water*—Water shall be clean, fresh, and potable (suitable for domestic consumption).

5.13 *Face Panels*—Face panels shall be $\frac{1}{2}$ in. (12.7 mm), $\frac{5}{8}$ in. (15.9 mm), or multiple laminations of regular or Type X gypsum board.

5.14 *Core Board*—Core board shall be $\frac{3}{4}$ or 1 in. (19 or 25.4 mm) either single thickness or multiple layers to the required 25 mm thickness.

6. Substrate, Surface Preparation

6.1 The attachment surface of any framing member shall not vary more than $\frac{1}{8}$ in. (3 mm) from the plane of the faces of adjacent framing members.

6.2 Wood framing shall be as straight and true as possible. Wood framing shall be securely attached following acceptable engineering practices and as required for the intended design.

NOTE 3—For installation of wood framing, see **Appendix X4**.

6.3 Metal framing members shall be of the proper size and design for their intended use and shall be installed in accordance with Specifications **C754** or **C1007** as required.

6.4 Where used as an alternative to framing, backing, or blocking, specially designed corner clips and edge clips shall be applied in accordance with their listings or approvals and the clip manufacturer's recommendations.

6.5 Devices or items attached to framing members, including the fasteners used to attach such devices or items, shall not protrude more than 1/8 in. (3 mm) beyond the surface to which the gypsum board is to be applied.

6.6 Masonry or concrete walls shall be dry, free of dust, oil, or form release agents, protrusions or voids, or foreign matter that inhibit bond for adhesively applied gypsum board.

6.7 All framing members and substrate shall be installed so that after the gypsum board has been applied, the finished surface will be in an even plane.

6.8 Gypsum board shall be kept free of any dirt, oil, or other foreign matter that cause a lack of bond. Foreign matter shall be removed.

6.9 All dents or gouges on the face of the gypsum board shall be brought up to a smooth level plane with the surface of the board.

6.10 Mechanical fasteners shall be set below the plane of the surface of the board.

6.11 All joints shall be true and even.

6.12 All gypsum board shall be tight against the framing member or substrate.

6.13 Deflection at design load of horizontal (ceiling) framing members supporting gypsum board shall be not more than L/240 of the span.

7. Application of Gypsum Board

7.1 General:

7.1.1 *Method of Cutting and Installation*—Gypsum board shall be cut by scoring and breaking or by sawing, working from the face side. When cutting by scoring, the face paper shall be cut with a sharp knife or other suitable tool. Gypsum board shall be broken by snapping the gypsum board in the reverse direction, or cut the back paper with a knife or suitable tool.

7.1.1.1 When cutting gypsum panels composed of two or more layers of gypsum board laminated together, both sides shall be scored deeply and then broken by snapping the gypsum board in either direction or by cutting with a hand or power tool.

7.1.1.2 When cutting gypsum panels having an attached laminate, the laminate side shall be scored or cut with a knife, or the panel shall be cut with a hand or power tool.

7.1.2 Cut edges and ends of the gypsum board shall be smoothed to obtain neat joints when installed. Holes for pipes, fixtures, or other small openings shall be scored on the back and the face in outline before removal or cut out with a saw or special tool designed for this purpose. Where gypsum board meets projecting surfaces, it shall be scribed and cut neatly.

7.1.3 When gypsum board is to be applied to both ceiling and walls, the gypsum board shall be applied first to the ceiling and then to the walls.

7.1.3.1 Gypsum board applied to walls shall be applied with the bottom edge spaced not less than 1/4 in. (6 mm) above the floor.

7.1.4 Where used at edges or ends, fasteners shall be spaced not more than 1 in. (25 mm) from edges and not less than 3/8 in. (10 mm) from edges and ends of gypsum board (except where floating angles are used). Perimeter fastening into the partition plate or sole at the top and bottom shall not be required except where the fire ratings, structural performance, or other special conditions require such fastening. While driving the fasteners, the gypsum board shall be held in firm contact with the underlying support. Application of fasteners shall proceed from the center or field of the gypsum board to the ends and edges.

7.1.5 Nails shall be driven with the heads slightly below the surface of the gypsum board, avoiding damage to the face and core of the board, such as breaking the paper or fracturing the core.

7.1.5.1 Length of nails shall be as shown in [Table 1](#).

7.1.6 Screws shall be driven to provide screw head penetration just below the gypsum board surface without breaking the surface paper of the gypsum board and without spinout.

NOTE 4—Refer to [Appendix X8](#) for guidance on some of the potential ways to minimize screw spinout in framing.

7.1.6.1 Length of screws shall be as shown in [Table 1](#).

7.1.7 Staples shall be driven with the crown parallel to the framing members, in such a manner that the crown bears tightly against the gypsum board without cutting into the face paper.

7.1.7.1 Staple attachment shall be restricted to the base plies only of gypsum board in a multi-ply system.

7.1.7.2 Length of staples shall be as shown in [Table 1](#).

7.1.8 The gypsum board shall be kept tight against the framing.

7.1.9 The external corners shall be protected with a metal corner bead or other suitable type of corner protection that shall be attached to supporting construction with fasteners or a crimping tool nominally 6 in. (150 mm) on centers (see [Section 3](#) and [Fig. 1](#)).

TABLE 1 Fastener Length for Gypsum Board Application to Wood Framing^A

Gypsum Board Thickness ^B in. (mm)	Minimum Nail Length ^C in. (mm)	Minimum Screw Length in. (mm)	Minimum Staple ^D Length in. (mm)
1/4 (6.4)	^E	^E	^E
3/8 (9.5)	1 1/4 (32)	1 (25)	1 (25)
1/2 (12.7)	1 3/8 (35)	1 1/8 (28)	1 1/8 (28)
5/8 (15.9)	1 1/2 (38)	1 1/4 (32)	1 1/4 (32)

^A Where fire resistance is required for gypsum board systems, fasteners of the same or larger length, shank diameter, and head bearing area as those described in the fire-rated design shall be used.

^B For other thicknesses, for multi-layer applications, or for application over rigid foam insulation, fasteners shall be of sufficient length to penetrate framing not less than 7/8 in. (22 mm) for nails, 5/8 in. (16 mm) for screws, and 5/8 in. (15 mm) for staples.

^C The maximum penetration for nails shall not exceed 1 1/4 in. (32 mm).

^D Staple attachment is restricted to base layers of multi-layer systems only. See 7.1.7.1.

^E For application over existing solid surfaces or in multi-layer applications only (see footnote B above for required fastener length).

7.2 Gypsum board shall not be used where it will be exposed to temperatures more than 125°F (52°C) for extended periods of time.

7.3 Gypsum board joints shall be located so that no joint will align with the edge of an opening unless control joints are to be installed at these locations.

7.4 Joints between gypsum boards shall be constructed with the gypsum board edges in moderate contact.

7.5 Joints shall be staggered, and joints on opposite sides of a partition shall not occur on the same stud.

7.6 Gypsum board used in building construction shall be not less than 8 in. (200 mm) from the finished grade in fully weather and water protected siding systems, and not less than 12 in. (300 mm) from the ground within properly drained and ventilated crawl spaces. Where ground moisture or humidity is extreme or continuous, or both, the crawl space ground surface shall be covered with a vapor barrier.

8. System I: Application of Single-ply Gypsum Board to Wood Framing Members

8.1 The maximum spacing for framing members for single-ply gypsum board assembly shall not exceed those shown in Table 2. <https://standards.iteh.ai/catalog/standards/sist/1d53ca04-8b96-4545-9761-177824e88a53/astm-c840-19>

8.1.1 The 1/4 in. (6.4 mm) thick gypsum board shall not be used in single-ply applications on either walls or ceilings.

8.2 In single-ply installation, all ends and edges of gypsum board shall occur over framing members or other solid backing except where treated joints occur at right angles to framing or furring members.

8.3 End joints shall be staggered and joints on opposite sides of a partition shall be arranged to occur on alternate framing members.

8.4 Application using nails.

8.4.1 Where a specific degree of fire resistance is required for gypsum board assemblies, nails of the same length, shank diameter, and head bearing area, as those described in the fire test report, shall be used.

8.4.2 *Single Nailing*—Nails shall be spaced a maximum of 7 in. (175 mm) on centers on ceilings, and a maximum of 8 in. (200 mm) on centers on walls (see Fig. 2).

8.4.3 *Double Nailing*—Nails shall be spaced as shown in Fig. 3 and driven as follows:

8.4.3.1 Starting at the center of the gypsum board, nails shall be applied as shown in solid dots in row 1, then rows 2 and 2A, 3 and 3A, 4 and 4A, always nailing from center to edges of sheet. The gypsum board shall be kept tight against the framing.

8.4.3.2 Second nails, shown by circles, shall be applied in the same manner as the first nails, also starting at row 1.

8.4.3.3 As an alternative procedure, the second nail shall be applied immediately after all nails in each row are driven in accordance with 8.4.3.2.

8.4.3.4 Single nailing shall be used on the perimeter of the gypsum board, unless otherwise specified.

8.4.3.5 Nails shall be inspected for compliance with 7.1.5 after the second nails have been set.

8.5 *Spacing of Screws*—Screws shall be spaced not more than 12 in. (300 mm) on centers along framing members for ceilings and 16 in. (406 mm) on centers for walls where the framing members are 16 in. (406 mm) on centers. Screws shall be spaced not more than 12 in. (300 mm) on centers along framing members for ceilings and walls where the framing members are 24 in. (610 mm) on centers.

Steel and PVC Trim and Casings

Cornerbead—(Numbers indicate width of flanges, i.e.—118 is 1 1/8 in. wide flange)

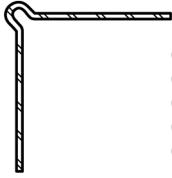

- CB—100 × 100
- CB—118 × 118
- CB—114 × 114
- CB—100 × 114
- CB—PF (Paper flange, steel corner combination bead)

"L" bead—(Numbers indicate thickness of board to be used)

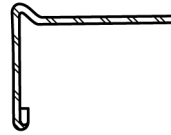

- L-38
- L-12
- L-58
- L-34

"U" Bead—(Numbers indicate thickness of board to be used, i.e.—38 is 3/8 in.)



- U-38
- U-12
- U-58
- U-34

"LK" Bead—(For use with Kerfed jamb)

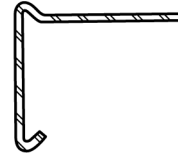

- LK-B
- LK-S
- (B-Bull or round nose)
- (S-Square nose)

Veneer Plaster Control Joint



"LC" Bead—(Numbers indicate thickness of board to be used)

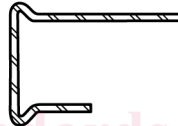

- LC-38
- LC-12
- LC-58
- LC-34

NOTE 1—All dimensions are in inch-pound units.

FIG. 1 Accessories

TABLE 2 Maximum Framing Spacing for Single-ply Construction^A

Single-ply Gypsum Board Thickness, in. (mm)	Application ^B	Maximum Framing Members On Centers Spacing, in. (mm)
Ceilings:		
3/8 (9.5) ^C	perpendicular	16 (406)
1/2 (12.7)	parallel	16 (406)
5/8 (15.9)	parallel	16 (406)
1/2 (12.7)	perpendicular	24 (610)
5/8 (15.9)	perpendicular	24 (610)
Sidewalls:		
3/8 (9.5)	perpendicular or parallel	16 (406)
1/2 (12.7)	perpendicular	24 (610)
or	or	
5/8 (15.9)	parallel	

^A Gypsum board ceilings to receive hand or spray-applied water-based texture material shall be applied perpendicular to framing and shall be either (i) 1/2 in. (12.7 mm) Gypsum Ceiling Board (see Specification C1396/C1396M) applied to framing not more than 24 in. (610 mm) on center, or (ii) other gypsum boards not less than 1/2 in. (12.7 mm) thick for 16 in. (406 mm) on center framing and not less than 5/8 in. (15.9 mm) thick for 24 in. (610 mm) on center framing.

^B Nails for gypsum board applied over existing surfaces shall have a flat head and diamond point, and shall penetrate not less than 7/8 in. (22 mm), nor more than 1 1/4 in. (32 mm) into the framing member.

^C 3/8-in. (9.5-mm) single-ply gypsum board shall not be applied to ceilings where the gypsum board supports insulation.

8.5.1 When using a combination of fasteners consisting of nails along the perimeter and screws in the field of the gypsum board, the spacing between a nail and an adjacent screw shall be not more than the spacing specified for screws in 8.5.

PERPENDICULAR CEILING APPLICATION

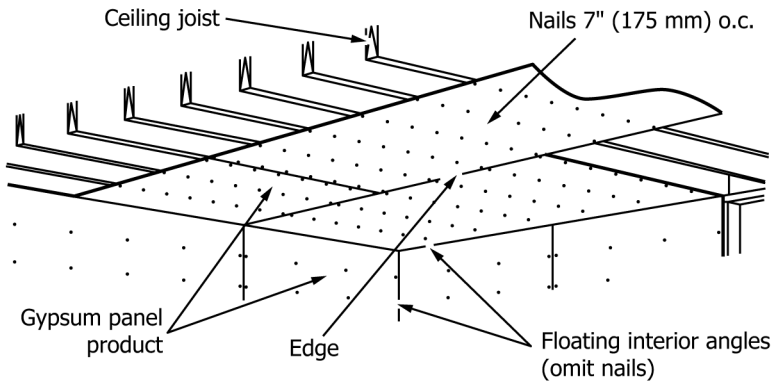

PARALLEL CEILING APPLICATION

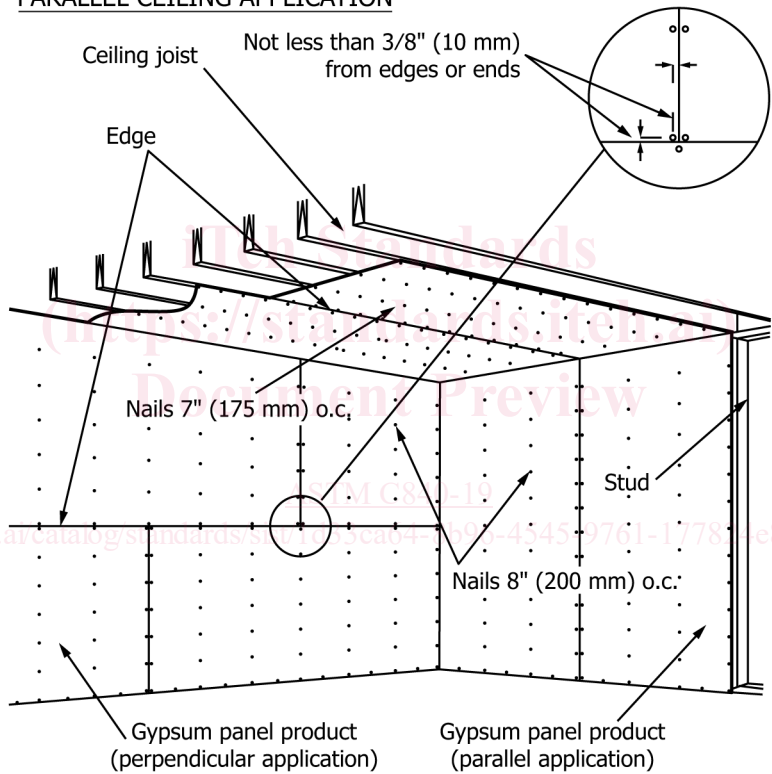

FIG. 2 Single Nailing

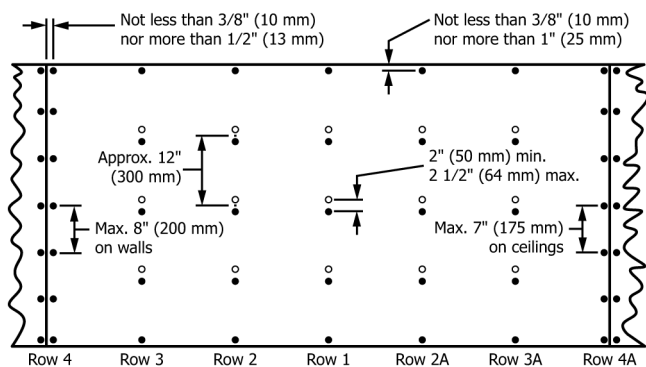

FIG. 3 Double Nailing

9. System II: Application of Two-ply Gypsum Board to Wood Framing Members

9.1 The maximum spacings for framing members for two-ply gypsum board assemblies shall not exceed those shown in **Tables 3 and 4**.

NOTE 5—See Section 2 for adhesive application method.

9.2 The fastener length for the base ply of gypsum board shall be as indicated in **Table 1**.

9.2.1 Base layer end joints parallel to and on the same side of framing members shall be staggered between alternate courses of gypsum board and from base layer joints on the opposite side of the framing members.

9.2.2 Base layer edge joints parallel to framing members shall be staggered on opposite sides of the framing members.

9.3 When adhesive is not used between the plies, the two plies of gypsum board shall be applied as indicated in **Tables 3 and 5**. The face ply shall be applied with the number of nails or screws required for normal single-ply application. Fastener length for face ply application shall be as indicated in footnote *B* of **Table 1**. Face ply joints that are parallel to framing shall fall over framing members and be offset from the base ply joints when two plies of gypsum board are parallel.

9.4 When an adhesive is used between the plies (laminated face ply), the two plies shall be applied as indicated in **Tables 4 and 5**. If the two plies are applied in parallel direction, the joints in the face ply shall be offset from the joints in the base ply.

9.4.1 Joints in the face ply need not occur over the framing members. The adhesive used between the two plies of gypsum board shall be uniformly applied over the back surface of the face ply of the gypsum board before it is erected or to the face surface of the base ply. The face ply of gypsum board shall be placed in position and fastened with nails or screws to hold gypsum board in place until the adhesive develops a bond.

9.4.2 Permanent fasteners shall be used around the perimeter 12 in. (300 mm) on centers and 16 in. (400 mm) on centers along framing members for the face ply of gypsum board applied on ceilings.

9.4.3 In place of nails and screws, the face ply of gypsum board applied on walls shall be held in position by shoring with props and headers, or other temporary support to ensure a pressure for bonding. Permanent fasteners shall be used on top and bottom of wall not more than 16 in. (400 mm) on centers. Nails or screws used to hold the gypsum board face ply shall be left in place and finished in the same manner as for single-ply gypsum board application (see Section 10).

9.5 Base layer joints and fasteners shall not be required to be taped or finished. Face layer joints and fasteners in multi-layer systems shall not be required to be finished unless required for appearance or decoration or as required for fire resistance.

10. System III: Application of Gypsum Board by Adhesive Nail-on to Wood Framing Members

10.1 Except as herein modified, application shall be in conformance with Section 8.

10.2 Surfaces of gypsum board and framing to receive the adhesive shall be free of dust, dirt, grease, or any other foreign matter that cause bond loss. Foreign matter shall be removed.

10.3 A bead of adhesive $\frac{3}{8}$ in. (10 mm) in diameter shall be applied to the face of all wood framing members, except plates, that support the gypsum board. The adhesive shall be spread to an average width of $\frac{3}{4}$ in. (20 mm) and an average thickness of $\frac{1}{16}$ in. (2 mm). See **Fig. 4** for application patterns.

10.3.1 Where a joining of two adjacent pieces of gypsum board occurs on a framing member, two parallel beads of adhesive shall be applied, one near each edge of the framing member.

10.4 Adhesive shall be applied to no greater area than can be covered with gypsum board within the “open time.”

TABLE 3 Maximum Framing Spacing for Two-ply Assemblies, Fasteners Only, No Adhesive Between Plies^A

	Gypsum Board Thickness, in. (mm)		Application Direction		Maximum On Centers Spacing of Framing, in. (mm)
	Base Ply	Face Ply	Base Ply	Face Ply	
Ceilings:					
$\frac{1}{4}$ (6.4)	$\frac{3}{8}$ (9.5) or $\frac{1}{2}$ (12.7)		perpendicular	perpendicular	16 (406)
$\frac{3}{8}$ (9.5)	$\frac{3}{8}$ (9.5) or $\frac{1}{2}$ (12.7)		perpendicular	perpendicular	16 (406)
$\frac{1}{2}$ (12.7)	$\frac{3}{8}$ (9.5) or $\frac{1}{2}$ (12.7)		parallel	perpendicular	16 (406)
$\frac{1}{2}$ (12.7)	$\frac{1}{2}$ (12.7) or $\frac{5}{8}$ (15.9)		perpendicular	perpendicular	24 (610)
$\frac{5}{8}$ (15.9) ^B	$\frac{1}{2}$ (12.7) or $\frac{5}{8}$ (15.9)		perpendicular	perpendicular	24 (610)
Walls:					
$\frac{1}{4}$ (6.4)	$\frac{1}{4}$ (6.4) or $\frac{3}{8}$ (9.5) or $\frac{1}{2}$ (12.7)		perpendicular or parallel	perpendicular or parallel	16 (406)
$\frac{3}{8}$ (9.5)	$\frac{1}{4}$ (6.4) or $\frac{3}{8}$ (9.5)		perpendicular or parallel	perpendicular or parallel	16 (406)
$\frac{1}{2}$ (12.7)	$\frac{1}{4}$ (6.4) or $\frac{3}{8}$ (9.5) or $\frac{1}{2}$ (12.7)		perpendicular or parallel	perpendicular or parallel	24 (610)
$\frac{5}{8}$ (15.9)	$\frac{1}{4}$ (6.4) or $\frac{3}{8}$ (9.5) or $\frac{1}{2}$ (12.7) or $\frac{5}{8}$ (15.9)		perpendicular or parallel	perpendicular or parallel	24 (610)

^A Gypsum board ceilings to receive hand or spray-applied water-based texture material shall be applied perpendicular to framing and shall be either (i) $\frac{1}{2}$ in. (12.7 mm) Gypsum Ceiling Board (see Specification **C1396/C1396M**) applied to framing not more than 24 in. (610 mm) on center, or (ii) other gypsum boards not less than $\frac{1}{2}$ in. (12.7 mm) thick for 16 in. (406 mm) on center framing and not less than $\frac{5}{8}$ in. (15.9 mm) thick for 24 in. (610 mm) on center framing.

^B $\frac{5}{8}$ in. (15.9 mm) board shall be permitted to be applied perpendicularly at 16 in. (406 mm) spacing.

TABLE 4 Maximum Framing Spacing for Two-ply Assembly Fasteners with Adhesive Between Plies^A

Gypsum Board Thickness, in. (mm)		Application Direction		Maximum On Centers Spacing of Framing, in. (mm)
Base Ply	Face Ply	Base Ply	Face Ply	
<i>Ceilings:</i>				
¼ (6.4)	¼ (6.4) or ⅜ (9.5) or ½ (12.7)	perpendicular	perpendicular	16 (406)
⅜ (9.5)	¼ (6.4) or ⅜ (9.5) or ½ (12.7)	perpendicular	perpendicular	16 (406)
½ (12.7)	¼ (6.4) or ⅜ (9.5) or ½ (12.7)	parallel	perpendicular	16 (406)
½ (12.7)	¼ (6.4) or ½ (12.7) or ⅝ (15.9)	perpendicular	perpendicular	24 (610)
⅝ (15.9)	¼ (6.4) or ½ (12.7) or ⅝ (15.9)	perpendicular	perpendicular	24 (610)
<i>Walls:</i>				
¼ (6.4)	¼ (6.4) or ⅜ (9.5) or ½ (12.7)	perpendicular or parallel	perpendicular or parallel	16 (406)
⅜ (9.5)	¼ (6.4) or ⅜ (9.5)	perpendicular or parallel	perpendicular or parallel	16 (406)
½ (12.7)	¼ (6.4) or ⅜ (9.5) or ½ (12.7)	perpendicular or parallel	perpendicular or parallel	24 (610)
⅝ (15.9)	¼ (6.4) or ½ (12.7) or ⅝ (15.9)	perpendicular or parallel	perpendicular or parallel	24 (610)

^A Adhesive between plies shall be dried or cured prior to joint treatment application.

TABLE 5 Base Layer Fastener Spacing for Multi-layer Gypsum Board Application

Location	Framing Spacing in. (mm)	Base Layer Nail Spacing in. (mm)		Base Layer Screw Spacing in. (mm)		Base Layer Staple Spacing in. (mm)	
		Where Face Layer is Laminated	Where Face Layer is Mechanically Attached	Where Face Layer is Laminated	Where Face Layer is Mechanically Attached	Where Face Layer is Laminated	Where Face Layer is Mechanically Attached
Walls	16 (406)	8 (200)	24 (600)	16 (400)	24 (600)	7 (175)	16 (400)
	24 (610)	8 (200)	24 (600)	12 (300)	24 (600)	7 (175)	16 (400)
Ceilings	16 (406)	7 (175)	16 (400)	12 (300)	24 (600)	7 (175)	16 (400)
	24 (610)	7 (175)	16 (400)	12 (300)	24 (600)	7 (175)	16 (400)

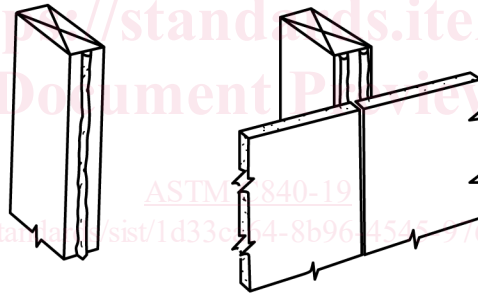

FIG. 4 Adhesive Application Patterns

NOTE 6—"Open time" is the time period available for working with certain adhesives before they set in accordance with the adhesive manufacturer's specification.

10.5 Fastener Spacing:

10.5.1 If the properties of the adhesive ensure bridging between the gypsum board and the wood framing, nailing shall not be required in the field of the board for walls. In such cases, perimeter nailing, 16 in. (400 mm) on centers, shall be required.

10.5.2 When the properties of the adhesive are such that there is no positive bridging between the gypsum board and the wood framing, either temporary field nailing or temporary bracing shall be used to ensure contact between the gypsum board, the adhesive, and the wood framing, until the adhesive develops a bond.

10.5.3 Unless specified otherwise by the adhesive manufacturer, fastener spacing shall be in accordance with **Table 6**.

11. System IV: Semi-solid Gypsum Board Partitions

11.1 Installation:

TABLE 6 Fastener Spacing with Adhesive or Mastic Application and Supplemental Fastening

Framing Member Spacing, in. (mm)	Ceilings, in. (mm)		Partitions Load Bearing, in. (mm)		Partitions Nonload Bearing, in. (mm)	
	Nail	Screw	Nail	Screw	Nail	Screw
On Centers						
16 (406)	16 (400)	16 (400)	16 (400)	24 (600)	24 (600)	24 (600)
24 (610)	12 (300)	16 (400)	12 (300)	16 (400)	16 (400)	24 (600)