



Designation: **F855--19a F855 - 20**

Standard Specifications for Temporary Protective Grounds to Be Used on De-energized Electric Power Lines and Equipment ¹

This standard is issued under the fixed designation F855; the number immediately following the designation indicates the year of original adoption or, in the case of revision, the year of last revision. A number in parentheses indicates the year of last reapproval. A superscript epsilon (ϵ) indicates an editorial change since the last revision or reapproval.

1. Scope

1.1 These specifications cover the equipment making up the temporary grounding system used on de-energized electric power lines, electric supply stations, and equipment.

1.2 It is common practice for the users of protective grounding equipment to prepare complete instructions and regulations to govern in detail the correct use and maintenance of such equipment.

1.3 The uses and maintenance of this equipment are beyond the scope of these specifications.

1.4 These specifications for a system of protective grounding utilizing copper cables are covered in four parts, as follows:

Clamps for Temporary Protective Grounds	Sections
Ferrules for Temporary Protective Grounds	4 - 16
Cables for Temporary Protective Grounds	17 - 30
Protective Grounds (Complete Assembly With Clamps, Ferrules, and Cable)	31 - 39
	40 - 52

1.5 Each of the four parts is an entity of itself, but is listed as a part of the system for completeness and clarification.

1.6 Currents presented in **Table 1** are based upon cable melting times, as determined from equations by I. M. Onderdonk and are to be used in situations involving an asymmetry value less than 20 % ($X/R \leq 1.8$). See **Appendix X1**.

1.6.1 Currents presented in **Table 2** are based upon the values from EPRI Project RP2446 Computer Program RTGC “A Desktop Computer Program for Calculating Rating of Temporary Grounding Cables” and are to be used in situations involving an asymmetry value greater than 20 % ($X/R \geq 1.8$), see **Appendix X2**.

NOTE 1—**Table 1** represents the clamp and assembly ratings that existed prior to this revision. **Table 2** represents new ratings now required for high X/R situations.

1.6.2 See **Appendix X1** and **Appendix X2** for a discussion of these topics.

¹ These specifications are under the jurisdiction of ASTM Committee F18 on Electrical Protective Equipment for Workers and are the direct responsibility of Subcommittee F18.45 on Mechanical Apparatus.

Current edition approved Nov. 1, 2019; Sept. 15, 2020. Published November 2019; October 2020. Originally approved in 1983. Last previous edition approved in 2019 as F855 - 19; F855 - 19a. DOI: 10.1520/F0855-19A; 10.1520/F0855-20.

TABLE 1 Protective Ground Cable, Ferrule, Clamp and Assembly Ratings for Symmetrical Current

Grade	Grounding Clamp Torque Strength, min				Short Circuit Properties ^A							Continuous Current Rating, A RMS, 60 Hz
	Yield ^B		Ultimate		Withstand Rating, Symmetrical kA RMS, 60 Hz			Ultimate Rating Capacity ^{CD} , Symmetrical kA RMS, 60 Hz				
					15 cycles (250 ms)	30 cycles (500 ms)	Copper Cable Size	15 cycles (250 ms)	30 cycles (500 ms)	60 cycles (1 s)	Maximum Copper Test Cable Size	
	lbf-in.	n-m	lbf-in.	n-m								
1	280	32	330	37	14	10	#2	18	13	9	2/0	200
2	280	32	330	37	21	15	1/0	29	21	14	4/0	250
3	280	32	330	37	27	20	2/0	37	26	18	4/0	300
4	330	37	400	45	34	25	3/0	47	33	23	250 kcmil	350
5	330	37	400	45	43	30	4/0	59	42	29	250 kcmil	400
6	330	37	400	45	54	39	250 kcmil or 2 2/0	70	49	35	350 kcmil	450
7	330	37	400	45	74	54	350 kcmil or 2 4/0	98	69	48	550 kcmil	550

^A Withstand and ultimate short circuit properties are based on performance with surges not exceeding 20 % asymmetry factor (see 9.1 and 12.3.4.2).
^B Yield shall mean no permanent deformation such that the clamp cannot be reused throughout its entire range of application.
^C Ultimate rating represents a symmetrical current which the assembly or individual components shall carry for the specified time.
^D Ultimate values are based upon application of Onderdonk's equation to 98 % of nominal circular mil area allowed by Specifications B172 and B173.

NOTE 1—TPG testing is done on complete assemblies. Assembly ratings assume the grade of lowest graded component (see 43.1.6).

1.7 The values stated in Newton-Meter units are to be regarded as the standard. The values in parentheses are the inch-pound units.

1.8 The following precautionary caveat pertains to the test method portions, Sections 12 and 25 of these specifications: *This standard does not purport to address all of the safety concerns, if any, associated with its use. It is the responsibility of the user of this standard to establish appropriate safety, health, and environmental practices and determine the applicability of regulatory limitations prior to use.*

1.9 *This international standard was developed in accordance with internationally recognized principles on standardization established in the Decision on Principles for the Development of International Standards, Guides and Recommendations issued by the World Trade Organization Technical Barriers to Trade (TBT) Committee.*

2. Referenced Documents <http://www.astm.org/catalog/standards/sist/1e10cb0d-ce54-4b49-b7ff-6714b0d1e371/astm-f855-20>

2.1 ASTM Standards:²

- B172 Specification for Rope-Lay-Stranded Copper Conductors Having Bunch-Stranded Members, for Electrical Conductors
- B173 Specification for Rope-Lay-Stranded Copper Conductors Having Concentric-Stranded Members, for Electrical Conductors
- D470 Test Methods for Crosslinked Insulations and Jackets for Wire and Cable
- D753 Specification for General Purpose Polychloroprene Jacket for Wire and Cable (Withdrawn 1984)³
- D2219 Specification for Poly(Vinyl Chloride) Insulation for Wire and Cable, 60°C Operation
- D2633 Test Methods for Thermoplastic Insulations and Jackets for Wire and Cable
- D2768 Specification for General-Purpose Ethylene-Propylene Rubber Jacket for Wire and Cable (Withdrawn 2007)³
- D2770 Specification for Ozone-Resisting Ethylene-Propylene Rubber Integral Insulation and Jacket for Wire and Cable (Withdrawn 2007)³
- E8/E8M Test Methods for Tension Testing of Metallic Materials

2.2 ANS/ANSI/IEEE Standard:⁴

- C 37.09 Standard Test Procedure for AC High-Voltage Circuit Breakers Rated on a Symmetrical Basis

2.3 ICEA/NEMA Standard:⁵

- ICEA S-19-81/NEMA WC 3-80 (R 1986) Rubber Insulated Wire and Cable for the Transmission and Distribution of Electrical Energy

² For referenced ASTM standards, visit the ASTM website, www.astm.org, or contact ASTM Customer Service at service@astm.org. For *Annual Book of ASTM Standards* volume information, refer to the standard's Document Summary page on the ASTM website.

³ The last approved version of this historical standard is referenced on www.astm.org.

⁴ Available from American National Standards Institute (ANSI), 25 W. 43rd St., 4th Floor, New York, NY 10036, http://www.ansi.org.

⁵ Available from The Insulated Cable Engineers Association, Inc. (ICEA), P.O. Box 2694, Alpharetta, GA 30023, http://www.icea.net.

TABLE 2 Ultimate Assembly Rating for High X/R Ratio Applications

Grade Size	Rating Rated Current (kA)	High Asymmetrical Test Requirements X/R = 30 Cycle Current Peak Values (kA) Rating X 2.69															Test Duration (cycles)	1 ² t (Mega amps ² -s)
		1st	2nd	3rd	4th	5th	6th	7th	8th	9th	10th	11th	12th	13th	14th	15th		
1H	15	41	37	34	32	30	28	27	26	25	25	24	24	23	23	23	15	74
2H	25	68	62	57	53	50	47	45	43	42	41	40	39	38	38	38	15	208
3H	31	84	76	70	65	61	58	56	53	52	50	49	48	47	47	46	15	312
4H	39	105	96	88	82	77	73	70	67	65	63	62	61	60	59	58	15	501
5H	47	127	116	106	99	93	88	84	81	78	76	74	73	72	71	70	15	728
6H	55	148	135	124	116	109	103	98	94	91	89	87	85	84	83	82	15	997
7H	68	183	167	154	143	134	127	121	117	113	110	107	105	104	102	101	15	1523

NOTE 1—The above current values are based on electromechanical test values.

NOTE 2—Assemblies that have been subjected to these shall not be re-used.

NOTE 3—For use with currents exceeding 20 % asymmetry factor.

NOTE 4—See X2.7.2 for additional information.

2.4 IEC Standard:⁶

IEC 61230 Ed. 2, 2008, Portable Equipment for Earthing or Earthing and Short-Circuiting

2.5 IEEE Standard:⁷

IEEE 386 Standard for Separable Insulated Connector Systems for Power Distribution Systems Above 600V

IEEE 1048 Guide for Protective Grounding of Power Lines

IEEE 1246 Guide for Temporary Protective Grounding Systems Used in Substations

3. Terminology

3.1 Definitions of Terms Specific to This Standard:

3.1.1 *continuous current rating*—designated RMS current which can be carried continuously under specified conditions.

3.1.2 *protective ground assembly*—a temporary electrical connection between a source of potential energization and the earth, rated for the maximum anticipated fault current or continuous induced current, or both.

3.1.2.1 Discussion—

Throughout this specification, kc mil = 1000 circular mils.

3.1.3 *protective grounding equipment*—devices installed temporarily on de-energized electric power circuits for the purposes of potential equalization and to conduct a short circuit current for a specified duration (time).

3.1.4 *time to failure*—failure time of the cable is the time between the initiation of current flow and the instant at which arcing begins.

3.1.5 *ultimate capacity*—this represents a current which it is calculated the component is capable of conducting for the specified time. It is expected that component damage may result. The component shall not be reused, except in test situations.

3.1.6 *withstand rating*—this represents a near symmetrical current which shall be conducted without any component being damaged sufficiently to prevent being operable and reusable. The protective ground shall be capable of passing a second test at this current after being cooled to ambient temperature.

CLAMPS FOR TEMPORARY PROTECTIVE GROUNDS

4. Scope

4.1 This specification covers clamps used with ferrules and elastomer or thermoplastic covered flexible cable in the manufacture of protective grounds installed temporarily for protective grounding of de-energized circuits.

5. Classification

5.1 Clamps are furnished in, but not limited to, three types according to their function and method of installation, as follows:

5.1.1 *Type I*—Clamps for installation on de-energized conductors equipped with eyes for installation with removable hot sticks.

5.1.2 *Type II*—Clamps for installation on de-energized conductors having permanently mounted hot sticks.

5.1.3 *Type III*—Clamps for installation on permanently grounded conductors or metal structures with tee handles, and eyes or square or hexagon head screw(s), or both.

5.1.4 Other types of special clamps, such as those for cluster grounds or for underground equipment grounding, may be made, tested, and certified by the manufacturer as meeting the requirements of this specification.

5.1.5 Separable insulated connectors used in manufacturing underground equipment grounding assemblies shall meet the requirements of IEEE 386.

⁶ Available from International Electrotechnical Commission (IEC), 3 rue de Varembé, Case postale 131, CH-1211, Geneva 20, Switzerland, <http://www.iec.ch>.

⁷ Available from Institute of Electrical and Electronics Engineers, Inc. (IEEE), 445 Hoes Ln., P.O. Box 1331, Piscataway, NJ 08854-1331, <http://www.ieee.org>.

5.2 Clamps are furnished in grades according to mechanical strengths, short circuit capabilities, and duration of faults, as indicated in **Table 1** or **Table 2**. For **Table 1** grade designations, clamp ratings must include maximum use current and indication whether testing was done at Ultimate or Withstand Ratings. The maximum use current listed shall not exceed the test current used in their electrical short circuit design tests (per **12.3.4**).

5.3 Clamps are furnished in two classes according to the characteristics of the main contact jaws:

5.3.1 *Class A*—Clamp jaws with smooth contact surfaces.

5.3.2 *Class B*—Clamp jaws with serrations, or cross hatching, or other means intended to abrade or bite through corrosion products on the surfaces of the conductor being clamped.

6. Sizes

6.1 Clamp size is the combination of the main contact and cable size ranges as listed by the manufacturers. It should be noted that the main contact may connect to a cable or bus bar or be used at the “ground end” to connect to a variety of conductive grounded objects.

7. Ordering Information

7.1 Orders for clamps under this specification shall include this ASTM designation and the following information:

7.1.1 Quantity,

7.1.2 Name (grounding clamp),

7.1.3 Main contact size ranges, conductor descriptions, and materials which are to be clamped by main contact,

7.1.4 Cable size, material, and description by which clamps are to be assembled,

7.1.5 Type (see **5.1**),

7.1.6 Grade (see **5.2** and **Table 1** or **Table 2**),

7.1.7 Class (see **5.3**),

7.1.8 Asymmetrical current or other supplementary requirements, if applicable. (See Supplementary Requirements S1 to S10 for styles and designs.)

NOTE 2—A typical ordering description is as follows: 100 Grounding Clamps, Main contact range #2 to 350 kcmil for 2/0 Copper flexible grounding cable, ASTM F855, Type 1, Grade 3, Class A, Design C, Style 7.

NOTE 3—It is expected that manufacturers will publish catalog data conforming to this specification that will combine the requirements of **7.1.1 – 7.1.8** in a single product number. With that system, a typical order description is: 100 (Smith Manufacturing Co. Product No. XXXX) grounding clamps ASTM F855, Grade 2-max use 21kA, Ultimate Rating.

8. Materials

8.1 Current carrying parts made of copper base or aluminum base alloy shall have the following material properties in accordance with Test Methods **E8/E8M**:

	Copper Base Alloy	Aluminum Base Alloy
Tensile strength, min	207 MPa (30 000 psi)	207 MPa (30 000 psi)
Yield strength, min	90 MPa (13 000 psi)	138 MPa (20 000 psi)
Elongation, min	6 %	3 %

8.2 Type II clamps shall be equipped with an insulating handle (hot stick) appropriate for the nominal voltage of the circuit to be grounded.

9. Electrical and Mechanical Properties

9.1 Electrical and mechanical properties shall conform to the requirements prescribed in [Table 1](#) or [Table 2](#), as appropriate, and the following paragraphs. See [Appendix X1](#) for a discussion and derivation of the current levels in [Table 1](#). See [Appendix X2](#) for a discussion of the effects of asymmetrical current and the derivation of the currents in [Table 2](#).

9.1.1 Types I and II stick installed clamps shall be designed such that a failure does not increase the risk of injury to the user or have excess mechanical strength to prevent failure, defined as follows:

9.1.1.1 In the event the clamp is over-torqued during installation, normal fracture shall be such that the attached cable remains under control by being retained with the stick.

9.1.1.2 Clamps with an ultimate torque strength exceeding 45 N·m (400 lbf·in.) are exempt from the provisions of [9.1.1.1](#).

9.1.2 Resistance from the main contact to the attached cable contact shall be less than that for an equal length of maximum size cable(s) for which the clamp is rated.

9.1.3 Main contacts shall accept and clamp all conductors or structural members in accordance with the manufacturer's rating.

9.1.4 Clamp shall accept hand assembly of all cables fitted with compatible ferrules as rated per [Table 3](#).

9.1.5 Cable termination shall include a cable support or shall be made to accept a cable supporting ferrule. This support shall secure the entire cable over the jacket and is provided in addition to the electrical connection to the strand.

9.1.6 Type I clamps shall be operable with clamp sticks and shall fit securely inside a nominal 13 mm (½ in.) wide slot in the head of the stick.

10. Workmanship, Finish, and Appearance

10.1 Components shall be free of structural porosity, fins, sharp edges, splits, cracks, and other defects that affect handling or performance.

10.2 All parts shall be formed, machined, and assembled with sufficient accuracy for smooth operation by hand, and shall be free of excessive looseness to the extent detrimental to repeated applications at the recommended installing torque.

10.3 Class A (smooth jaw) clamps shall have smooth contact surfaces free of burrs, fins, or other protuberances that would impair performance.

10.4 Class B (serrated jaw) clamps shall have longitudinally level surfaces that, with clamp movement as specified by the manufacturer, will provide a cleaning effect on the surface of the conductor from the serrations or crosshatching present.

10.5 Snag grinding marks, depressions, and other surface irregularities which do not affect strength, performance, or handling are not cause for rejection.

11. Sampling

11.1 A product model represents a manufacturer's design specification standard according to which the production lot is manufactured.

11.2 A production lot shall consist of all clamps of one product model produced at one time.

11.3 A test sample shall consist of two specimens for each different test specified. Specimens are selected at random and shall pass

TABLE 3 Cable Terminations and Compatible Ferrules for Protective Ground Clamps

Grounding Clamp			Matching Cable Ferrule		
ASTM Cable Termination Style	Cable Termination Description	Essential Size Data	ASTM Ferrule Type	Ferrule Description	Essential Data ^A
					Size
1	Cable retaining eyebolt	ferrule OD accepted Stud and shroud OD accepted	I III	compression plain stud shrouded compression	compressed OD stud dia and compressed shroud dia
2	eyebolt and cable support	ferrule or stud dia accepted	I	compression	compressed OD
3	plain bore bolted clamp and cable support		III	plain stud shrouded compression	stud dia and compressed shroud dia
4	plain bore tubular with screws and cable support				
5	plain bore boss	nominal ID ½ in. (12.7 mm), ⅝ in. (16 mm), or ¾ in. (20 mm) and included angle of cone contact	IV	threaded stud shrouded	stud or bolt dia ^A ½ in.-13NC, ⅝ in.-11 NC, or ¾ in.-10 NC and included angle of cone contact
6	plain bore boss and cable support		I V IV V VI	compression bolted shrouded compression threaded stud shrouded compression bolted shrouded compression threaded stud compression ferrule	
7	threaded bore boss	thread size ^B ½ in.-13 NC, ⅝ in.-11 NC, or ¾ in.-10 NC	IV	threaded stud shrouded compression	stud size ^A ½ in.-13 NC, ⅝ in.-11 NC, or ¾ in.-10 NC
8	threaded bore boss and cable support		VI	threaded stud compression ferrule	
9	threaded bore clamp and cable support				

^A The material shall be copper or aluminum base. The cable size and material description shall include overall outside diameter.

^B Bolt stud and thread sizes metric conversion is as follows: ½ in. – 13 NC ≈ M12 × 1.75, ⅝ in. – 11 NC ≈ M16 × 2.00, ¾ in. – 10 NC ≈ M20 × 2.50.

iTech Standards
(<https://standards.itih.ai>)
Document Preview

<https://standards.itih.ai/catalog/standards/sist/1e10cb0d-ce54-4b49-b7ff-6714b0d1e371/astm-f855-20>

the inspection requirements of Section 13. When a failure occurs in one specimen from the first sample, a second sample from the same lot shall be selected and tested. If the second sample (two specimens) passes, the lot shall be accepted. If one specimen from the second sample fails, the lot shall be rejected.

12. Design Tests

12.1 The design tests that follow shall be made on test samples of each product model to verify that the requirements of this specification are met.

12.2 Mechanical Torque Strength:

12.2.1 Install the clamp on the main conductor of the minimum and maximum size for which the clamp is rated and apply torsional force to the main screw. Force may be applied to other devices designed to secure the clamp on the conductor.

12.2.2 Measure torque by a torque wrench that indicates torque directly or by another manner easily convertible.

12.2.3 The main conductor is defined as the material(s) for which the clamp is rated to be used.

12.2.4 Yield and ultimate strength shall equal or exceed the values shown in Table 1.

12.3 Electrical Short Circuit Capacity:

12.3.1 Assemble the ~~clamp with protective grounding equipment with cable, ferrules and cable clamps~~ in accordance with the manufacturer's specifications. The current is to be determined by the method described in ~~ANSI C37.09-1979 (R-1989, Section ANSI/IEEE C37.09, latest revision, 7)~~. ~~Cables shall have a minimum length of 3 m (10 ft).~~ Qualification testing of protective ground assembly methods and components such as clamps, ferrules and cable shall use a cable length of 10 ft ± 4 in. (3 m). Other cable lengths and protective grounding equipment configurations may be tested to this standard as agreed upon between the vendor and user.

12.3.2 Electrode spacing shall be as specified in Fig. 1, with the clamps in a vertical position, in order that the slack cable length stresses the clamps with electromagnetic tensile impact during test surge.

12.3.3 Test the clamp on the main conductor within the rated range established by manufacturer.

12.3.4 Short circuit values and time durations specified by the customer shall be as specified in Table 1 or Table 2, as appropriate. Table 2 shall be used if no asymmetrical currents have been specified.

12.3.4.1 The withstand rating of Table 1 represents a near symmetrical current which the clamp shall conduct without being damaged sufficiently to prevent being operable and reusable.

12.3.4.2 The ultimate rating of Table 1 represents a current which the clamp shall carry for the specified time. The clamp thus tested might be damaged and shall not be reused.

12.3.4.3 The ultimate rating of Table 2 represents an asymmetrical current at an X/R ratio of 30 which the clamp shall carry for the specified time. The clamp thus tested might be damaged and shall not be reused.

12.4 Grounding, clamps and ferrules tested at their continuous current rating shall have a lower maximum temperature than that of the maximum size copper main or tap cable for which rated. Temperature shall be measured at the warmest spot on the clamp, midpoint on the ferrule and on the metal strand at the midpoint of the main and top conductors, each a minimum of 1.5 m (5 ft).

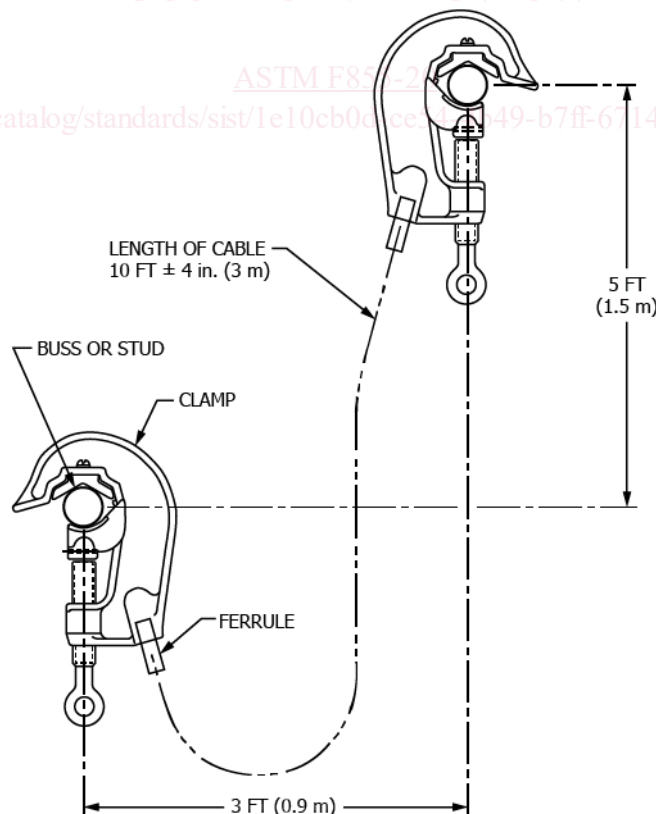

FIG. 1 Fixture for Testing Ground Clamps, Ferrules, Cables, and Jumpers

13. Inspection and Product Testing

13.1 The clamps shall be inspected and tested as follows:

13.1.1 Verification of the main contact and cable capacities shall be in accordance with 9.1.2 and 9.1.3.

13.1.2 Visual inspection and hand operation to verify workmanship, finish, and appearance shall be in accordance with Section 10.

13.1.3 Torque test on a test sample shall be in accordance with 12.2.

14. Acceptance, Rejection, and Rehearing

14.1 At the option of the purchaser, a production lot may be subjected to the following:

14.1.1 Inspection in accordance with 13.1 for operation, main contact range, workmanship, and appearance. Individual clamps that do not conform may be rejected.

14.1.2 Resistance comparison test in accordance with 9.1.2.

14.2 Material that fails to conform to the requirements of this specification may be rejected. Rejection should be reported to the producer or supplier promptly and in writing. In case of dissatisfaction with the results of the test, the producer or supplier may make claim for a rehearing.

14.3 If electrical, or mechanical testing, or both, are required by a user prior to acceptance, minimum testing shall be done in accordance with this specification for any part or for all of the tests to be performed.

15. Certification

15.1 When specified in the purchase order or contract, a manufacturer's or supplier's certification shall be furnished to the purchaser that the clamps were manufactured, sampled, tested, and inspected in accordance with this specification and found to meet the requirements. When specified in the purchase order or contract, a report of design test, or surge test oscillogram, or both, shall be furnished.

16. Packaging and Package Marking

16.1 Clamps shall be marked with the name or logo of the manufacturer, identity number, and date code to indicate year of manufacture.

16.2 A packing list indicating manufacturer's product numbers and quantities of each different clamp shall be provided with each shipment.

16.3 Each shipment shall be packaged to provide protection of the contents appropriate for the mode of transportation.

CABLE FERRULES FOR TEMPORARY PROTECTIVE GROUNDS

17. Scope

17.1 This specification covers ferrules used with cables, clamps, and connectors in the manufacture of protective grounds, installed temporarily for protective grounding of de-energized circuits.

18. Classification

18.1 Ferrules are furnished in five types as shown in Table 4 and Table 5, and are as follows:

18.1.1 *Type I*—Compression ferrule is cylindrical and made for installation on cable stranding by compression.

TABLE 4 Protective Ground Cable Ferrule Physical Specifications

Note—Inspection or vent holes are optional for Types III, IV, V, and VI.

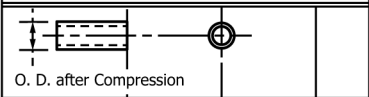
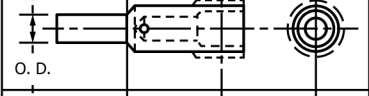
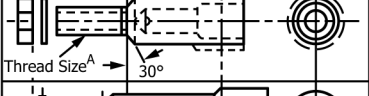
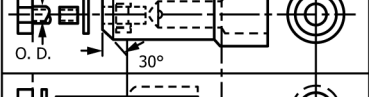
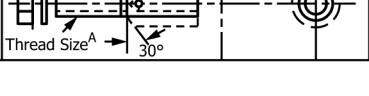
Type	Description	Shape	Minimum Specifications to be Supplied by Manufacturers in Addition to Cable Capacity and Material
I	Compression		Installing Die Code O. D. after Installation
III	Plain Stud Shrouded Compression		Installing Die Codes Stud O. D.
IV	Threaded Stud Shrouded Compression		Installing Die Codes Thread Size ^A
V	Bolted Shrouded Compression		Installing Die Codes Bolt O. D. or Thread Size
VI	Threaded Compression		Installing Die Codes Thread Size ^A

^A Standard thread sizes are as follows: 1/2 in. – 13 UNC ≈ M12 × 1.75, 5/8 in. – 11 UNC ≈ M16 × 2.00, 3/4 in. – 10 UNC ≈ M20 × 2.50.

TABLE 5 Protective Ground Cable Ferrule and Compatible Clamp Terminations

Note—Inspection or vent holes are optional for Types III, IV, V, and VI.

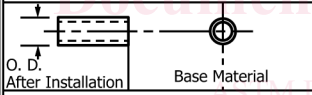
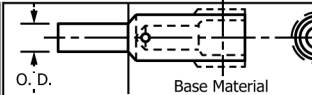
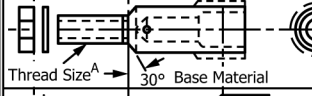
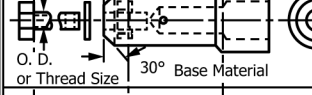
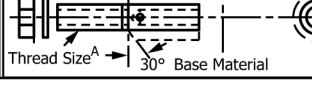
CABLE FERRULES ASTM			MATCHING GROUNDING CLAMP CABLE TERMINATION ASTM		
ASTM Ferrule Type	Ferrule Description	Illustration of Ferrule Including Essential Interface Application Data Required	ASTM Termination Style	Termination Description	Essential Interface Application Data Required
I	Compression Ferrule		1.	Cable Retaining Eyebolt	Ferrule or Stud O. D. Accepted
			2.	Eyebolt & Cable Support	
			3.	Plain Bore Clamp and Cable Support	
			4.	Plain Bore Tubular With Screws and Cable Support	
III	Plain Stud Shrouded Compression Ferrule				
IV	Threaded Stud Shrouded Compression Ferrule		5.	Plain Bore Boss	Tap Boss I. D. or Thread Size ^A and Material
V	Bolted Shrouded Compression Ferrule		6.	Plain Bore Boss and Cable Support	
			7.	Threaded Bore Boss	
VI	Threaded Compression Ferrule		6.	Plain Bore Boss and Cable Support	Tap Boss Thread Size ^A and Material
			8.	Threaded Bore Boss and Cable Support	
			9.	Threaded Bore Clamp and Cable Support	

^A Standard thread sizes are as follows: 1/2 in. – 13 UNC ≈ M12 × 1.75, 5/8 in. – 11 UNC ≈ M16 × 2.00, 3/4 in. – 10 UNC ≈ M20 × 2.50.

18.1.2 *Type III*—Plain stud-shrouded compression ferrule has a stepped bore that accepts entire cable over jacket.

18.1.3 *Type IV*—Threaded stud shrouded compression ferrule has a stepped bore that accepts entire cable over jacket and has male threads at forward end.

18.1.4 *Type V*—Bolted shrouded compression ferrule has internal threads and a bolt at forward end.

18.1.5 *Type VI*—Threaded stud compression ferrule has male threads at forward end.

18.2 Ferrules are furnished in grades in accordance with cable capacity, short circuit capabilities, and duration of faults as indicated in **Table 1** or **Table 2**. For **Table 1** grade designations, ferrule ratings must include maximum use current and indication whether testing was done at Ultimate or Withstand Ratings. The maximum use current listed shall not exceed the test current used in their electrical short circuit design tests (per **25.2.3**).

19. Size

19.1 Ferrule size is the combination of cable capacity, stud description, and size after installation of cable (see **Table 1** for standard sizes according to types and minimum grade requirements).

20. Ordering Information

20.1 Orders for ferrules under this specification should include this ASTM designation and the following information:

20.1.1 Quantity,

20.1.2 Unit of measure (each or pair),

20.1.3 Name (grounding cable ferrules),

20.1.4 Tap contact size, description, and material of clamp or connector in which ferrule is to be installed,

20.1.5 Cable description, to include strand size, material, and outside diameter on which ferrule is to be installed,

20.1.6 Type (see **18.1**),

20.1.7 Grade (see **18.2** and **Table 2**), and

20.1.8 Asymmetrical current or other supplementary requirements, if applicable (see Supplementary Requirements S1 to S17).

NOTE 4—A typical ordering description is as follows: 100 Pairs Grounding Cable Ferrules, for tap contact 5/8-11 NC aluminum clamp and grounding cable 4/0-2019 W CU 21 mm (0.83 in.) O.D., ASTM F855, Type IV, Grade 5 or 5H.

NOTE 5—It is expected that manufacturers will publish catalog data conforming to this specification which will combine the requirements of **20.1.2 – 20.1.8** in a single product number. With that system, a typical order description is as follows: 100 (Smith Manufacturing Co. Product No. XXXX) grounding cable ferrules, ASTM F855, Grade 5-max use 30kA, Withstand Rating.

21. Materials

21.1 Materials used shall meet the requirements of **8.1**. Current carrying parts of copper base or aluminum base ferrules shall meet the following requirements:

21.1.1 *Copper Base Alloy*—Copper content 60 % minimum.

21.1.2 *Aluminum Base Alloy*—Aluminum content 90 % minimum.

22. Electrical and Physical Properties

22.1 Closed end ferrules utilizing the compression method for cable installation may have a 3 mm (0.125 in.) minimum diameter inspection vent hole through one side at the bottom of the (cable) bore. This applies to Types III, IV, V, and VI.

22.2 Ferrules shall accept cables for which they are rated without alteration of strands, and can be assembled by hand with compatible clamps.