



Standard Guide for Conducting a Stability Test (Lightweight Survey and Inclining Experiment) to Determine the Light Ship Displacement and Centers of Gravity of a Vessel¹

This standard is issued under the fixed designation F1321; the number immediately following the designation indicates the year of original adoption or, in the case of revision, the year of last revision. A number in parentheses indicates the year of last reapproval. A superscript epsilon (ϵ) indicates an editorial change since the last revision or reapproval.

This standard has been approved for use by agencies of the U.S. Department of Defense.

INTRODUCTION

This guide provides the marine industry with a basic understanding of the various aspects of a stability test. It contains procedures for conducting a stability test to ensure that valid results are obtained with maximum precision at a minimal cost to owners, shipyards, and the government. This guide is not intended to instruct a person in the actual calculation of the light ship displacement and centers of gravity, but rather to be a guide to the necessary procedures to be followed to gather accurate data for use in the calculation of the light ship characteristics. A complete understanding of the correct procedures used to perform a stability test is imperative to ensure that the test is conducted properly and so that results can be examined for accuracy as the inclining experiment is conducted. It is recommended that these procedures be used on all vessels and marine craft.

1. Scope

1.1 This guide covers the determination of a vessel's light ship characteristics. In this standard, a vessel is a traditional hull-formed vessel. The stability test can be considered to be two separate tasks; the lightweight survey and the inclining experiment. The stability test is required for most vessels upon their completion and after major conversions. It is normally conducted inshore in calm weather conditions and usually requires the vessel be taken out of service to prepare for and conduct the stability test. The three light ship characteristics determined from the stability test for conventional (symmetrical) ships are displacement ("*displ*"), longitudinal center of gravity ("*LCG*"), and the vertical center of gravity ("*KG*"). The transverse center of gravity ("*TCG*") may also be determined for mobile offshore drilling units (MODUs) and other vessels which are asymmetrical about the centerline or whose internal arrangement or outfitting is such that an inherent list may develop from off-center weight. Because of their nature, other special considerations not specifically addressed in this guide may be necessary for some MODUs. This standard is not

applicable to vessels such as a tension-leg platforms, semi-submersibles, rigid hull inflatable boats, and so on.

1.2 The limitations of 1 % trim or 4 % heel and so on apply if one is using the traditional pre-defined hydrostatic characteristics. This is due to the drastic change of waterplane area. If one is calculating hydrostatic characteristics at each move, such as utilizing a computer program, then the limitations are not applicable.

1.3 The values stated in inch-pound units are to be regarded as standard. No other units of measurement are included in this standard.

1.3.1 *Exceptions*—Other units may be used for the stability test, but the test results should be reported in the same units and coordinate system as the vessel's draft marks and Trim and Stability Book or similar stability information provided.

1.4 *This standard does not purport to address all of the safety concerns, if any, associated with its use. It is the responsibility of the user of this standard to establish appropriate safety, health, and environmental practices and determine the applicability of regulatory limitations prior to use.*

1.5 *This international standard was developed in accordance with internationally recognized principles on standardization established in the Decision on Principles for the Development of International Standards, Guides and Recommendations issued by the World Trade Organization Technical Barriers to Trade (TBT) Committee.*

¹ This guide is under the jurisdiction of ASTM Committee F25 on Ships and Marine Technology and is the direct responsibility of Subcommittee F25.01 on Structures.

Current edition approved May 1, 2021. Published May 2021. Originally approved in 1990. Last previous edition approved in 2021 as F1321 – 14 (2021). DOI: 10.1520/F1321-21.

2. Referenced Documents

- 2.1 ASTM Standards:²
E100 Specification for ASTM Hydrometers

3. Terminology

3.1 Definitions:

3.1.1 *inclining experiment, n*—involves moving a series of weights, in the transverse direction, and then measuring the resulting change in the equilibrium heel angle of the vessel. By using this information and applying basic naval architecture principles, the vessel’s vertical center of gravity *KG* is determined.

3.1.2 *Condition 1, n*—vessel in Condition 1 is a vessel complete in all respects, but without consumables, stores, cargo, crew and effects, and without any liquids on board except machinery fluids, such as lubricants and hydraulics, are at operating levels. Condition 1 is sometimes referred to as “operational light ship.”

3.1.3 *Condition 0, n*—vessel in Condition 0 is a vessel as inclined.

3.1.4 *lightweight survey, n*—this task involves taking an audit of all items which must be added, deducted, or relocated on the vessel at the time of the stability test so that the observed condition of the vessel can be adjusted to the light ship condition. The weight, longitudinal, transverse, and vertical location of each item must be accurately determined and recorded. Using this information, the static waterline of the ship at the time of the stability test as determined from measuring the freeboard or verified draft marks of the vessel, the vessel’s hydrostatic data, and the seawater density; the light ship displacement and longitudinal center of gravity can be obtained. The transverse center of gravity may also be calculated, if necessary.

3.1.5 *relative density, n*—(formerly known as *specific gravity*)—ratio of the mass of a given volume of material at a stated temperature to the mass of an equal volume gas free distilled water at the same or different temperatures. Both referenced temperatures shall be explicitly stated.

4. Significance and Use

4.1 From the light ship characteristics one is able to calculate the stability characteristics of the vessel for all conditions of loading and thereby determine whether the vessel satisfies the applicable stability criteria. Accurate results from a stability test may in some cases determine the future survival of the vessel and its crew, so the accuracy with which the test is conducted cannot be overemphasized. The condition of the vessel and the environment during the test is rarely ideal and consequently, the stability test is infrequently conducted exactly as planned. If the vessel is not 100 % complete and the weather is not perfect, there ends up being water or shipyard trash in a tank that was supposed to be clean and dry and so

forth, then the person in charge must make immediate decisions as to the acceptability of variances from the plan. A complete understanding of the principles behind the stability test and a knowledge of the factors that affect the results is necessary.

5. Theory

5.1 *The Metacenter*—(See Fig. 1). The transverse metacenter (“*M*”) is based on the hull form of a vessel and is the point around which the vessel’s center of buoyancy (“*B*”) swings for small angles of inclination (0° to 4° unless there are abrupt changes in the shape of the hull). The location of *B* is fixed for any draft, trim, and heel, but it shifts appreciably as heel increases. The location of *B* shifts off the centerline for small angles of inclination (“ θ ”), but its height above the molded keel (“*K*”) will stay essentially the same. The location of *M*, on the other hand, is essentially fixed over a range of heeling angles up to about 4°, as the ship is inclined at constant displacement and trim. The height of *M* above *K*, known as “*KM*”, is often plotted versus draft as one of the vessel’s curves of form. As a general “rule of thumb,” if the difference from the design trim of the vessel is less than 1 % of its length, the *KM* can be taken directly from either the vessel’s curves of form or hydrostatic tables. Because *KM* varies with trim, the *KM* must be computed using the trim of the ship at the time of the stability test when the difference from the design trim of the vessel is greater than 1 % of its length. Caution should be exercised when applying the “rule of thumb” to ensure that excessive error, as would result from a significant change in the waterplane area during heeling, is not introduced into the stability calculations.

5.2 *Metacentric Height*—The vertical distance between the center of gravity (“*G*”) and *M* is called the metacentric height (“*GM*”). At small angles of heel, *GM* is equal to the initial slope of the righting arm (“*GZ*”) curve and is calculated using the relationship, $GZ = GM \sin \theta$. *GM* is a measure of vessel stability that can be calculated during an inclining experiment. As shown in Fig. 1 and Fig. 2, moving a weight (“*W*”) across the deck a distance (“*x*”) will cause a shift in the overall center of gravity (*G–G'*) of the vessel equal to $(W)(x)/displ$ and parallel to the movement of *W*. The vessel will heel over to a new equilibrium heel angle where the new center of buoyancy, *B'*, will once again be directly under the new center of gravity (*G'*). Because the angle of inclination during the inclining experiment is small, the shift in *G* can be approximated by

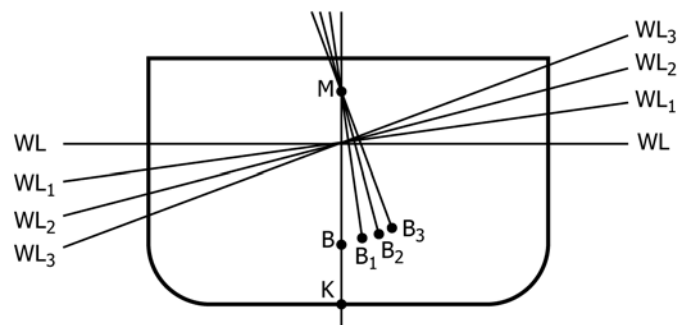

FIG. 1 Movement of the Center of Buoyancy

² For referenced ASTM standards, visit the ASTM website, www.astm.org, or contact ASTM Customer Service at service@astm.org. For Annual Book of ASTM Standards volume information, refer to the standard’s Document Summary page on the ASTM website.

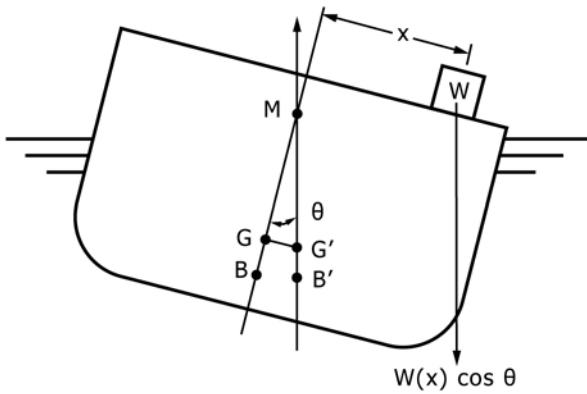

FIG. 2 Metacentric Height

5.3 Calculating the Height of the Center of Gravity Above the Keel— KM is known for the draft and trim of the vessel during the stability test. The metacentric height, GM , as calculated above, is determined from the inclining experiment. The difference between the height KM and the distance GM is the height of the center of gravity above the keel, KG . See Fig. 4.

5.4 Measuring the Angle of Inclination—(See Fig. 5.) Each time an inclining weight, W , is shifted a distance, x , the vessel will settle to some equilibrium heel angle, θ . To measure this angle, θ , accurately, pendulums or other precise instruments are used on the vessel. When pendulums are used, the two sides of the triangle defined by the pendulum are measured. (“ Y ”) is the length of the pendulum wire from the pivot point to the batten and (“ Z ”) is the distance the wire deflects from the reference position at the point along the pendulum length where transverse deflections are measured. *Tangent* θ is then calculated:

$$\tan \theta = Z/Y \quad (2)$$

After each weight movement, plotting all of the readings for each of the pendulums during the inclining experiment aids in the discovery of bad readings. Since $(W)(x)/\tan \theta$ should be constant, the plotted line should be straight. Deviations from a straight line are an indication that there were other moments acting on the vessel during the inclining. These other moments must be identified, the cause corrected, and the weight movements repeated until a straight line is achieved. Figs. 6-9 illustrate examples of how to detect some of these other moments during the inclining and a recommended solution for each case. For simplicity, only the average of the readings is shown on the inclining plots.

5.5 Free Surface—During the stability test, the inclining of the vessel should result solely from the moving of the inclining weights. It should not be inhibited or exaggerated by unknown moments or the shifting of liquids on board. However, some liquids will be aboard the vessel in slack tanks so a discussion of “free surface” is appropriate.

5.5.1 Standing Water on Deck—Decks should be free of water. Water trapped on deck may shift and pocket in a fashion similar to liquids in a tank.

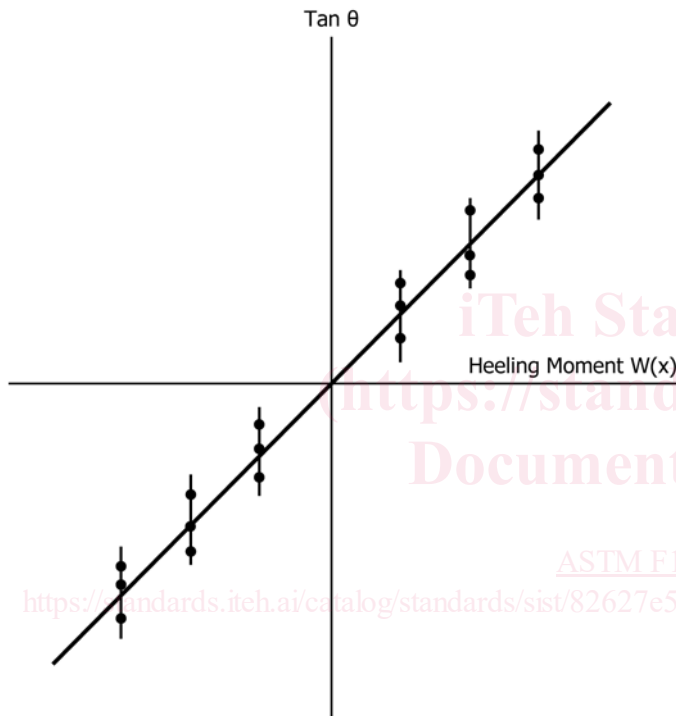

FIG. 3 A Typical Incline Plot

$GM \tan \theta$ and then equated to $(W)(x)/displ$. Rearranging this equation slightly results in the following equation:

$$GM = \frac{(W)(x)}{(displ)(\tan \theta)} \quad (1)$$

Since GM and $displ$ remain constant throughout the inclining experiment the ratio $(W)(x)/\tan \theta$ will be a constant. By carefully planning a series of weight movements, a plot of tangents is made at the corresponding moments. The ratio is measured as the slope of the best represented straight line drawn through the plotted points as shown in Fig. 3, where three angle indicating devices have been used. This line does not necessarily pass through the origin or any other particular point, for no single point is more significant than any other point. A linear regression analysis is often used to fit the straight line.

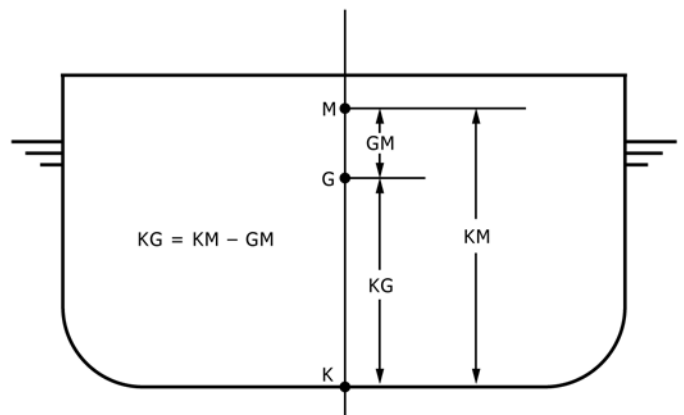

FIG. 4 Relationship between GM , KM , and KG

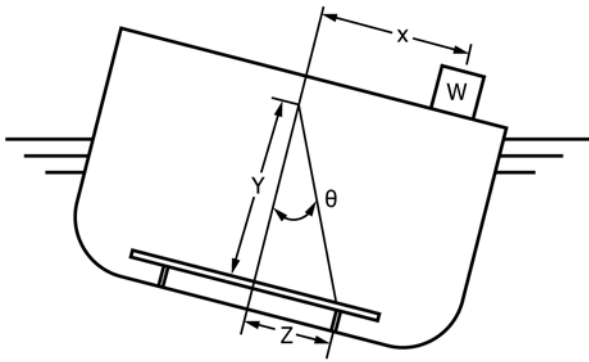
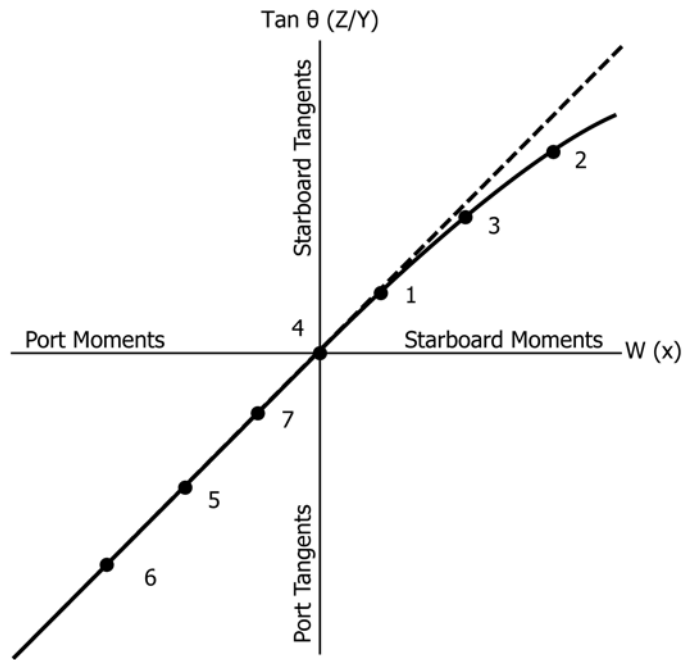
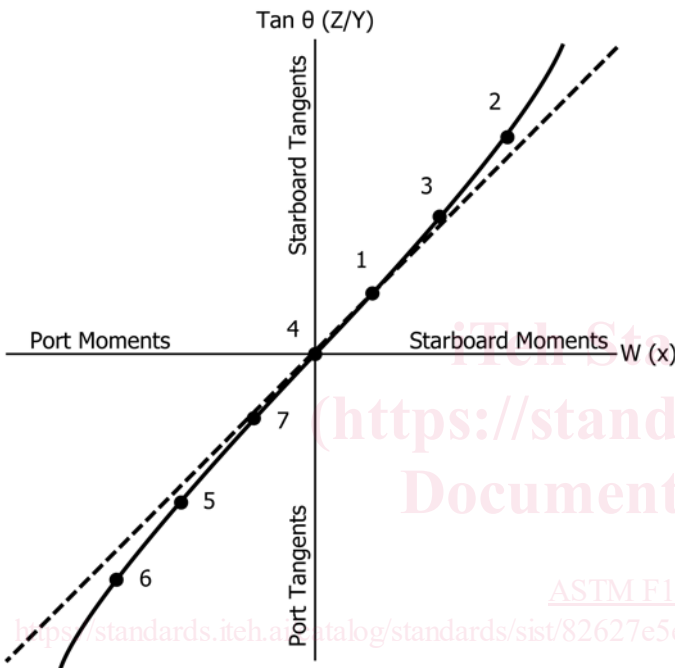

FIG. 5 Measuring the Angle of Inclination



NOTE 1—Take water soundings and check lines; redo Weight Movements 2 and 3.

FIG. 7 Vessel Touching Bottom or Restrained by Mooring Lines



NOTE 1—Recheck all tanks and voids and pump out as necessary; redo all weight movements and recheck freeboard and draft readings.

FIG. 6 Excessive Free Liquids

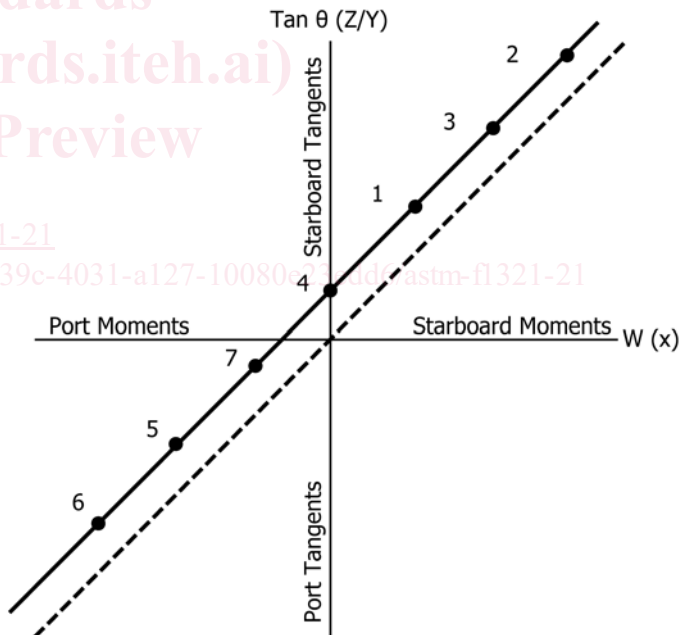
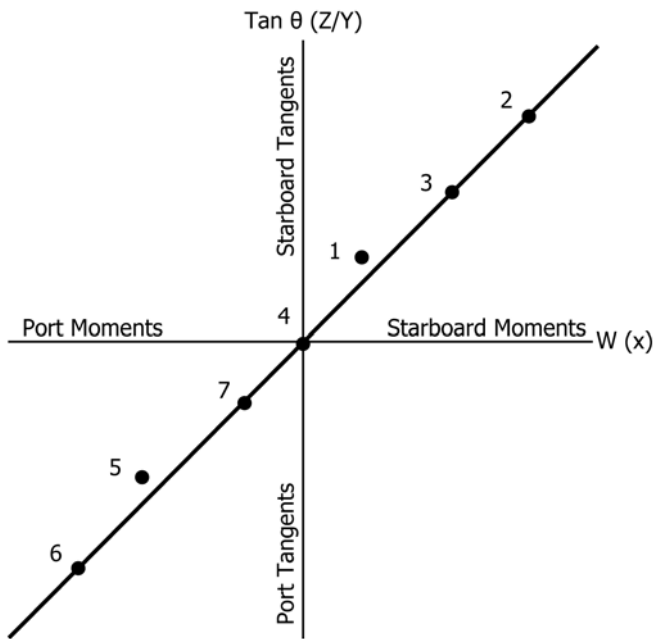

FIG. 8 Steady Wind From Port Side Came Up After Initial Zero Point Taken (Plot Acceptable)

5.5.2 *Tankage During the Inclining*—If there are liquids on board the vessel when it is inclined, whether in the bilges or in the tanks, it will shift to the low side when the vessel heels. This shift of liquids will exaggerate the heel of the vessel. Unless the exact weight and distance of liquid shifted can be precisely calculated, the GM from Eq 1 will be in error. Free surface should be minimized by emptying the tanks completely and making sure all bilges are dry or by completely filling the tanks so that no shift of liquid is possible. The latter method is not the optimum because air pockets are difficult to remove from between structural members of a tank, and the weight and center of the liquid in a full tank must be accurately determined to adjust the light ship values accordingly. When tanks must be left slack, it is desirable that the sides of the tanks be parallel vertical planes and the tanks be regular in shape (that is,

rectangular, trapezoidal, and so forth) when viewed from above, so that the free surface moment of the liquid can be accurately determined. The free surface moment of the liquid in a tank with parallel vertical sides can be readily calculated by the equation:



NOTE 1—Redo Weight Movements 1 and 5.

FIG. 9 Gusty Wind From Port Side

$$M_{fs} = lb^3/12Q \quad (3)$$

where:

- M_{fs} = free surface moment, ft-Ltons
- l = length of tank, ft,
- b = breadth of tank, ft,
- Q = specific volume of liquid in tank (ft³/ton), and
(See Annex A3 for liquid conversions or measure Q directly with a hydrometer.)
- Lton = long ton of 2240 lbs.

Free surface correction is independent of the height of the tank in the ship, location of the tank, and direction of heel.

5.5.3 As the width of the tank increases, the value of free surface moment increases by the third power. The distance available for the liquid to shift is the predominant factor. This is why even the smallest amount of liquid in the bottom of a wide tank or bilge is normally unacceptable and should be removed before the inclining experiment. Insignificant amounts of liquids in V-shaped tanks or voids (for example, a chain locker in the bow), where the potential shift is negligible, may remain if removal of the liquid would be difficult or would cause extensive delays.

6. Preparations for the Stability Test

6.1 *General Condition of the Vessel*—A vessel should be as complete as possible at the time of the stability test. Schedule the test to minimize the disruption in the vessel’s delivery date or its operational commitments. The amount and type of work left to be completed (weights to be added) affects the accuracy of the light ship characteristics, so good judgment must be used. If the weight or center of gravity of an item to be added cannot be determined with confidence, it is best to conduct the stability test after the item is added. Temporary material, tool boxes, staging, trash, sand, debris, and so forth on board should be reduced to absolute minimum during the stability test.

Equipment that may shift during the inclining, such as Z-drives or cargo gear, must be securely locked in place.

6.2 *Tankage*—Include the anticipated liquid loading for the test in the planning for the test. Preferably, all tanks should be empty and clean or completely full. Keep the number of slack tanks to a minimum. The viscosity of the fluid and the shape of the tank should be such that the free surface effect can be accurately determined. All cross-connects between tanks must be closed. When conducting a lightweight survey only, strict adherence to the following sub-paragraphs may not be required, so long as all tankage is static, measureable and quantified at the time of the stability test. When an inclining experiment is part of the stability test, the tankage during the lightweight survey must remain the same as during the inclining to the greatest extent possible.

6.2.1 Slack Tanks:

6.2.1.1 The number of slack tanks should normally be limited to one pair of port and starboard tanks or one centerline tank of the following:

- (1) Freshwater reserve feed tanks,
- (2) Fuel/diesel oil storage tanks,
- (3) Fuel/diesel oil day tanks,
- (4) Lube oil tanks,
- (5) Sanitary tanks, or
- (6) Potable water tanks.

6.2.1.2 To avoid pocketing, slack tanks should normally be of regular (that is, rectangular, trapezoidal, and so forth) cross section and be 20 to 80 % full if they are deep tanks and 40 to 60 % full if they are double-bottom tanks. These levels ensure that the rate of shifting of liquid remains constant throughout the heel angles of the stability test. If the trim changes as the vessel is inclined, then consideration must also be given to longitudinal pocketing. Slack tanks containing liquids of sufficient viscosity to prevent free movement of the liquids, as the vessel is inclined (such as Bunker C at low temperature), should be avoided since the free surface cannot be calculated accurately. A free surface correction for such tanks should not be used unless the tanks are heated to reduce viscosity. Communication between tanks should never be allowed. Cross connections, including those via manifolds, should be closed. Equal liquid levels in slack tank pairs can be a warning sign of open cross connections. A bilge, ballast, and fuel oil piping plan can be referred to, when checking for cross-connection closures.

6.2.2 *Pressed Up Tanks*—*Pressed up* means completely full with no voids caused by trim or inadequate venting. Anything less than 100 % full, for example, the 98 % condition regarded as full for operational purposes, is not acceptable. The vessel may be rolled from side to side to eliminate entrapped air before taking the final sounding. Special care should be taken when pressing fuel oil tanks to prevent accidental pollution. An example of a tank that would appear “pressed up,” but actually contained entrapped air is shown in Fig. 10.

6.2.3 *Empty Tanks*—It is generally not sufficient simply to pump tanks until suction is lost. Enter the tank after pumping to determine if final stripping with portable pumps or by hand is necessary. The exceptions are very narrow tanks or tanks where there is a sharp deadrise, since free surface would be

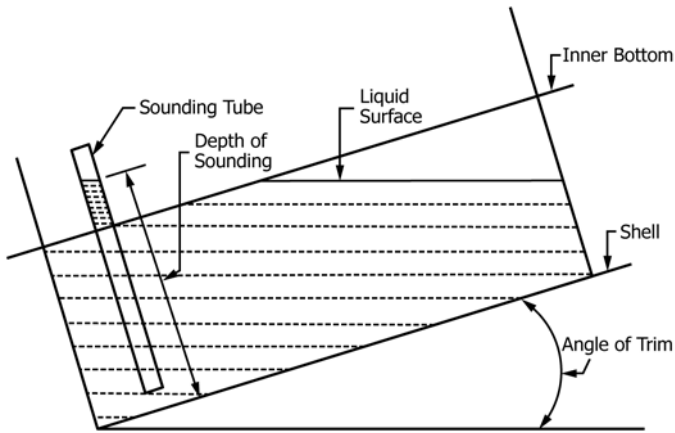

FIG. 10 Tank Containing Entrapped Air

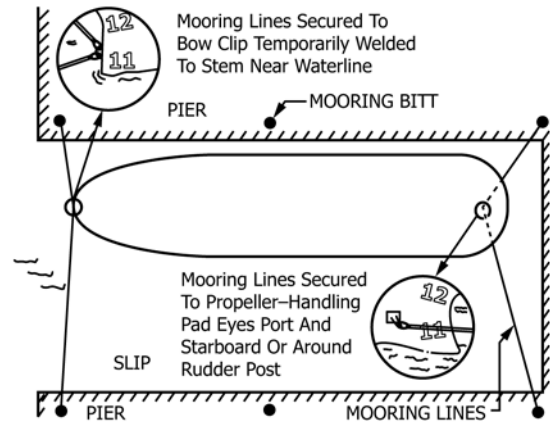

FIG. 11 The Preferred Mooring Arrangement

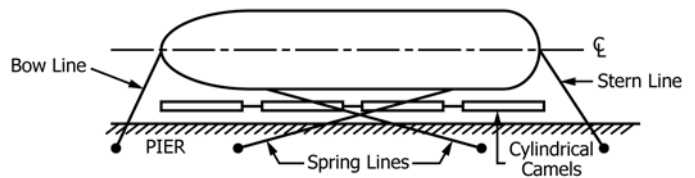

FIG. 12 An Acceptable Alternate Mooring Arrangement

negligible. Since all empty tanks must be inspected, all manholes must be open and the tanks well ventilated and certified as safe for entry. A safe testing device should be on hand to test for sufficient oxygen and minimum toxic levels.

6.3 Mooring Arrangements—The importance of good mooring arrangements cannot be overemphasized. The arrangement selection will be dependent upon many factors. Among the most important are depth of water, wind, and current effects. Whenever possible, the vessel should be moored in a quiet, sheltered area free of extraneous forces such as propeller wash from passing tugs or sudden discharges from shoreside pumps. The depth of water under the hull should be sufficient to ensure that the hull will be entirely free of the bottom at the maximum inclination angle. The tide conditions and the trim of the vessel during the test must be considered. Before the test, measure the depth of water and record in as many locations as necessary to ensure the vessel will not contact the bottom. If marginal, conduct the test during high tide or move the vessel to deeper water.

6.3.1 The vessel should be held by lines at the bow and the stern, attached to temporary pad eyes installed as close as possible to the centerline of the vessel and as near the waterline as practical. If temporary pad eyes are not feasible, then lines can be secured to bollards or cleats, or both, on the deck. This arrangement requires that the lines be slackened when the ship is heeled away from the dock. The preferred arrangement is with the vessel lying in a slip where it can be moored as shown in Fig. 11. In this case, the lines can be kept taut to hold the vessel in place, yet allowing unrestricted heeling. Note, however, that wind or current, or both, may cause a superimposed heeling moment to act on the vessel throughout the test. For steady conditions, this will not affect the results. Gusty wind or uniformly varying wind or current, or both, will cause these superimposed heeling moments to change, which may require additional test points to obtain a valid test. The need for additional test points can be determined by plotting test points as they are obtained.

6.3.2 Where the vessel can be moored to one side only, it is good practice to supplement the bow and stern lines with two spring lines to maintain positive control of the vessel, as shown in Fig. 12. The leads of the spring lines should be as long as

practicable. Provide cylindrical camels between the vessel and the dock. All lines should be slack, with the vessel free of the pier and camels, when taking readings.

6.3.2.1 If the vessel is held off the pier by the combined effect of the wind and current, and the bow and stern lines are secured at centerline near the waterline, they can be taut. This is essentially the same as the preferred arrangement described in 6.3.1. As in 6.3.1, varying wind or current, or both, will cause some distortion of the plot.

6.3.2.2 If the vessel is pressed against the camels by wind or current, or both, all lines should be slack. The cylindrical camels will prevent binding, but again there will be an unavoidable superimposed heeling moment as a result of the ship bearing against the camels. This condition should be avoided but when used, give consideration to positioning the ship free of the dock and camels, and letting the ship drift as readings are taken. The vessel may be held away from the dock by tugs, or pushed off the dock from shoreside by hand or by using equipment such as forklifts with pusher knees.

6.3.2.3 Another acceptable arrangement is where the combined wind and current are such that the ship may be controlled by only one line at either the bow or the stern. In this case the control line need not be attached near the waterline, but it should be led from on or near the center line of the ship. With all lines but one slack, the ship is free to veer with the wind or current, or both, as readings are taken. This can sometimes be troublesome because varying wind or current, or both, can cause distortion of the plot.

6.3.3 If a floating crane is used for handling inclining weights it should not be moored to the ship.

6.3.4 Remove the access ramps and gangways. Shore connections, hoses, and so forth connected to shore should be at a minimum and kept slack at all times.

6.4 *List and Trim*—To simplify calculations the vessel should be as close as possible to even list and design trim and have sufficient draft so that any abrupt changes in the waterplane will be avoided as the ship is inclined from side to side. If the vessel has a bow appendage, such as a bulbous bow or sonar dome, hard chine, or transom stern at the waterline, then give consideration to changing the draft or trim to ensure there is a minimum change in the waterplane area as the vessel is heeled from side to side. Trim different from design of up to 1 % of length between perpendiculars (“LBP”) is normally acceptable when using hydrostatic data calculated at design trim. Exercise caution when applying the “1 % rule of thumb” to ensure that excessive error, as would result from a significant change in the waterplane area during heeling, is not introduced into the stability calculations. With inclining weights in the initial position, up to ½ ° of list is acceptable. If the list exceeds this, use leveling weights to put the vessel in an acceptable condition. In accordance with 1.2, if generating hydrostatic calculations onboard for each condition, these limitations are not applicable.

6.5 *Test Weights*—Test weight positions and movements should be preplanned and provided to test personnel and responsible members of the ship’s force participating in the experiment well prior to loading weights for experiment. Note also that the movement path should be checked to minimize the possibility of damage due to striking ship structure or fittings with a weight or crane fall.

6.5.1 The total weight used should be sufficient to provide a minimum inclination of 1° and a maximum of 4° of heel. One approach that can be taken to estimate how much weight is needed follows:

6.5.1.1 Measure the maximum athwartships distance, x , that is available on deck to shift the weights as shown in Fig. 13.

6.5.1.2 Estimate the draft the vessel will be at for the stability test and find the corresponding displacement from the vessel’s hydrostatic data.

6.5.1.3 Estimate the GM of the vessel by estimating its center of gravity, KG , and subtracting that value from KM , obtained from the hydrostatic data for the appropriate draft;

$$GM = KM - KG \quad (4)$$

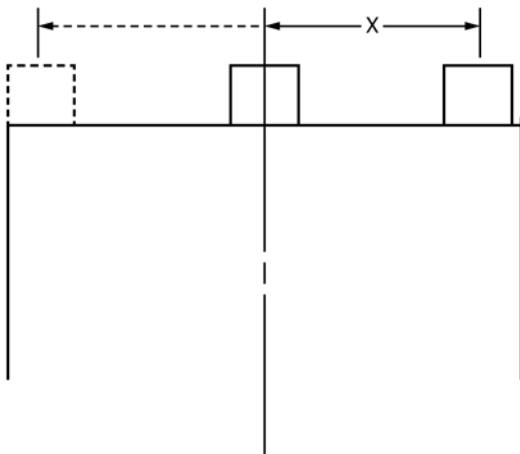

FIG. 13 Movement of the Test Weights

6.5.1.4 Estimate the total weight, W , required by the following equation:

$$W = \frac{GM (\tan \theta) displ}{x} \quad (5)$$

where θ is the desired angle of inclination between 1° and 4°.

6.5.1.5 It would be prudent to have additional weights readily available to compensate for any inaccurate estimates.

6.5.2 Test weights should be compact and of such a configuration that the vertical center of gravity of the weights can be accurately determined. Weights, such as porous concrete, that can absorb significant amounts of moisture, should only be used if they were weighed just before the stability test or if recent weight certificates are presented. Mark each weight with an identification number and weight. For small vessels, drums completely filled with water may be used. Drums should normally be full and capped to allow accurate weight control.

6.5.2.1 Certify test weights using a certificated scale. Perform the weighing close enough in time to the stability test to ensure the measured weight is accurate. The time since weighing depends on the construction of the weight.

6.5.3 A crane of sufficient capacity and reach, or some other means, must be available during the stability test to shift weights on the deck in an expeditious and safe manner.

6.5.4 Take precautions to ensure that the decks are not overloaded during weight movements. If deck strength is questionable, then perform a structural analysis to determine if existing framing can support the weight.

6.5.5 The test weights should be on board and in place before the scheduled time of the stability test.

6.5.6 The standard test uses eight weight moves, three on each side and stopping at the starting point as the weights are being moved to the other side and upon completion.

6.6 *Pendulums:*

6.6.1 Use a minimum of three pendulums to allow identification of bad readings at any one pendulum station. They should each be located in an area protected from the wind. If this is not possible, then erect a screen around the exposed portions of the pendulums. Pendulums should be located forward, midship, and aft. Preferred locations for pendulums are ladder trunks, elevator shafts, hatchways, or any access way passing through decks.

6.6.2 The pendulums should be long enough to give a measured deflection, to each side of upright, of at least 6 in. Usually, the longer the pendulum the greater the accuracy of the test; however, if excessively long pendulums are used on a tender ship, the pendulums may not settle down and the accuracy of the pendulums would then be questionable. On smaller vessels, where there is insufficient headroom to hang long pendulums, obtain the 6-in. deflection by increasing the test weight so as to increase the list. The typical inclination is between 2° and 3° but in no case should the maximum angle of list be greater than 4°. As shown in Fig. 14, the pendulums must be at least 87 in. long to get at least 6 in. of deflection without exceeding the 4° maximum heel.

6.6.3 The pendulums should be of different lengths to avoid the natural frequencies and, the possibility of collusion between station recorders. The pendulum wire should be piano

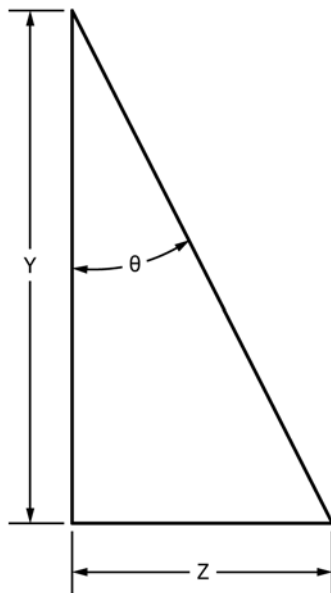

$$\begin{aligned} \tan \theta &= Z/Y \\ \tan 4^\circ &= 6 \text{ in.}/Y \\ Y &= 6 \text{ in.}/\tan 4^\circ \\ Y &= 6 \text{ in.}/0.0699 \\ Y &= 87 \text{ in.} \\ \tan 3^\circ &= 6 \text{ in.}/Y \\ Y &= 6 \text{ in.}/\tan 3^\circ \\ Y &= 6 \text{ in.}/0.0524 \\ Y &= 114 \text{ in.} \\ \tan 2^\circ &= 6 \text{ in.}/Y \\ Y &= 6 \text{ in.}/\tan 2^\circ \\ Y &= 6 \text{ in.}/0.0349 \\ Y &= 172 \text{ in.} \end{aligned}$$

FIG. 14 Angle of Inclination Versus Pendulum Length

wire or other monofilament material. The top connection of the pendulum should afford unrestricted rotation of the pivot point. An example is that of a washer with the pendulum wire attached suspended from a nail.

6.6.4 A weighted winged pendulum bob (such as two angles connected at their heels) shall be immersed in a trough filled with a liquid to dampen oscillations after each weight movement. Liquid detergent generally works well. The trough should be deep enough to prevent the pendulum bob from touching the bottom.

6.6.5 The battens should be smooth, light-colored wood, 1/2 to 3/4 in. thick, and should be securely fixed in position so that an inadvertent contact will not cause them to shift. The batten should be aligned close to the pendulum wire but not in contact with it.

6.6.6 The pendulums should be in place before the scheduled time of the stability test.

6.6.7 A typical satisfactory arrangement is shown in Fig. 15. The pendulums may be placed in any location on the vessel, longitudinally and transversely.

6.7 Water Tubes:

6.7.1 Water tubes may be substituted for pendulums. However, at least one pendulum must be used for the test.

6.7.2 At a minimum, three (3) water tubes should be arranged to allow personnel to read and record deflections caused by the weight shift during the stability test on either side

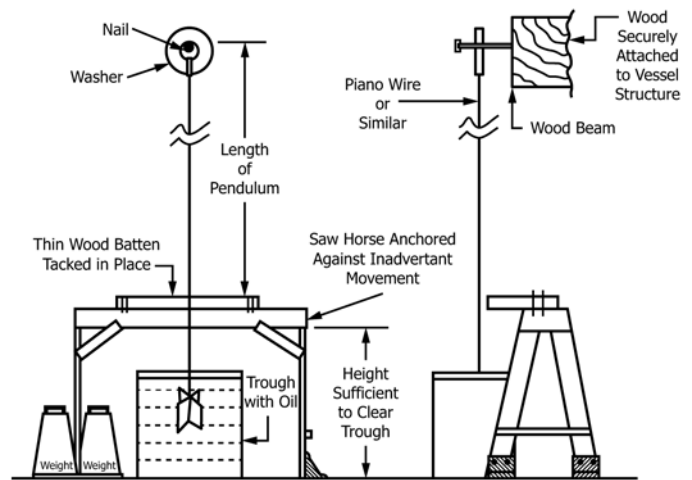

FIG. 15 Typical Satisfactory Pendulum Arrangement

of the ship. Like the pendulum, the greater the span between the vertical ends of the water tube apparatus, the higher the deflection readings when shifting the weight. Water tubes shall be arranged to give equivalent measurement precision as a pendulum. Water tubes should be located forward, midship, and aft.

6.7.3 The flexible water tubes should be long enough to lay freely athwartships on the ship and extend vertically on the ends of an apparatus.

6.7.4 Make sure the water tube is free of any air bubbles. Trapped air bubbles will cause an error in the deflection readings. Generally, when using three water tubes in parallel with one another, different colored dye is added to each water tube to allow personnel recording the deflections to do so without discrepancy. This also ensures that the port and starboard legs of the tube are correctly matched. Note that a stopcock on each end of each tube allows them to be moved or otherwise inclined without loss of the fluid, but verify that the stopcocks are fully open during each measurement.

6.7.5 Rulers or battens should be fixed to the vertical ends of the water tube apparatus to easily read the deflection in the water tube.

6.7.6 The water tube apparatus is usually located in an unobstructed section of the boat deck where it can pass freely from side to side. Note that the tube connecting the water levels may run freely vertically and fore and aft, etc. as convenient provided that no point on the tube is higher than the measurement area and that no air pockets are formed.

6.8 Digital Inclometers:

6.8.1 Calibrated digital inclinometers with an ability to display at least hundredths (0.01) of a degree and an accuracy of ±five-hundredths (0.05) of a degree may be substituted for pendulums. However, at least one pendulum must be used for the test.

6.8.2 Inclinometers should be located with the active axis athwartships and in an unobstructed area easily viewed by personnel to record. If the reading does not stabilize at a single number, an average of at least five maximum-minimum swings (therefore, ten readings) should be recorded for each weight movement.

6.9 No other angle measuring device should be excluded from use during an inclining experiment if it can be shown to be equivalent in precision and accuracy as a pendulum. Substitution of such devices for pendulums would be at the discretion of the approving authority.

6.10 *Communications Arrangements:*

6.10.1 One person at a central control station should have complete control over all personnel involved in the test.

6.10.2 There should be efficient two-way communications between central control and the weight handlers and between central control and each pendulum station.

6.10.3 Shelter the central control station from the elements, and have adequate lighting so that a plot of tangents versus heeling moments can be made during the test. It is desirable that the weight handlers be directly observed from the control station.

6.11 *Additional Requirements:*

6.11.1 **Annex A1** contains additional requirements that must be met, if U.S. Coast Guard approval of the stability test is needed.

6.11.2 **Annex A2** contains additional requirements that must be met for stability tests on U.S. Navy vessels.

6.11.3 Inclining procedures should be presented to the approving authority prior to conducting the stability test.

7. Plans and Equipment Required

7.1 *Plans*—The person in charge of the inclining should have available a copy of the following at the time of the stability test:

- 7.1.1 Lines plan,
- 7.1.2 Curves of form (hydrostatic curves) or hydrostatic data,
- 7.1.3 General arrangement plan of decks, holds, inner bottoms, and so forth,
- 7.1.4 Outboard profile,
- 7.1.5 Inboard profile,
- 7.1.6 Midship section,
- 7.1.7 Capacity plan showing capacities and vertical and longitudinal centers of gravity of cargo spaces, tanks, and so forth,
- 7.1.8 Tank sounding tables,
- 7.1.9 Draft mark locations, and
- 7.1.10 Docking drawing with keel profile and draft mark corrections (if available).

7.2 *Equipment*—Besides the physical equipment necessary such as the inclining weights, pendulums, small boat, and so forth, the following are necessary and should be provided by or made available to the person in charge of the inclining:

- 7.2.1 Three engineering scales for measuring pendulum deflections (rules should be subdivided into at least tenths of an inch),
- 7.2.2 Three sharp pencils for marking pendulum deflections,
- 7.2.3 Chalk for marking the various positions of the inclining weights,
- 7.2.4 A sufficiently long measuring tape for measuring the movement of the weights and locating different items on board,

7.2.5 A sufficiently long sounding tape for sounding tanks and taking freeboard readings,

7.2.6 One or more relative density hydrometers as prescribed in Specification **E100** for general use with range sufficient to cover 0.999 to 1.030, to measure the relative density of the water in which the vessel is floating,

7.2.7 Other hydrometers as necessary to measure the relative density of any liquids on board,

7.2.8 As a backup to computer plotting, graph paper to plot inclining moments versus tangents,

7.2.9 A straight edge to draw the measured waterline on the lines drawing,

7.2.10 A pad of paper to record data,

7.2.11 An explosion proof testing device to check for sufficient oxygen and absence of lethal gases in tanks and other closed spaces such as voids and cofferdams,

7.2.12 A thermometer, and

7.2.13 A calculator,

7.2.14 A digital camera, and

7.2.15 Draft tubes (if necessary).

7.3 *Substitutes*—Substitution of such other devices for the equipment above, such as refractometers for hydrometers, would be at the discretion of the approving authority.

8. Procedure

8.1 The inclining experiment, the freeboard/draft readings, and the survey, may be conducted in any order and still achieve the same results. If the person conducting the stability test is confident that the survey will show that the vessel is in an acceptable condition and there is the possibility of the weather becoming unfavorable, then it is suggested that the inclining be performed first and the survey last. If the person conducting the test is doubtful that the vessel is complete enough for the test, it is recommended that the survey be performed first since this could invalidate the entire test, regardless of the weather conditions. It is very important that all weights, the number of people on board, and so forth, remain constant throughout the test. **Appendix XI** contains a stability test check list that can be used to make a quick check that the procedure is correctly followed.

8.1.1 *Initial Walk Through and Survey*—The person responsible for conducting the stability test should arrive on board the vessel well in advance of the scheduled time of the test to ensure that the vessel is properly prepared for the test. If the ship to be inclined is large, a preliminary walk-through may need to be done the day preceding the actual incline. To ensure the safety of personnel conducting the walk-through, and to improve the documentation of surveyed weights and deficiencies, at least two persons should make the initial walk-through. Things to check include: all compartments are open, clean, and dry, tanks are well ventilated and gas free; movable or suspended items are secured and their position documented; pendulums are in place; weights are on board and in place; a crane or other method for moving weights is available; and the necessary plans and equipment are available. Before beginning the stability test, the person conducting the test should:

8.1.1.1 Consider the weather conditions. The combined adverse effect of wind, current, and sea may result in difficulties or even an invalid test due to the following:

- (1) Inability to record freeboards and drafts accurately,
- (2) Excessive or irregular oscillations of the pendulums, and
- (3) Variations in unavoidable superimposed heeling moments.

In some instances, unless conditions can be sufficiently improved by moving the vessel to a better location, it may be necessary to delay or postpone the test. Any significant quantities of rain, snow, or ice must be removed from the vessel before the test.

8.1.1.2 Make a quick overall survey of the vessel to make sure the vessel is complete enough to conduct the test and to ensure that all equipment is in place.

8.1.1.3 Enter all empty tanks after it is determined that they are well ventilated and gas free to ensure that they are dry and free of debris. Ensure that any pressed up tanks are indeed full and free of air pockets.

8.1.1.4 Survey the entire vessel to identify all items that need to be added to the vessel, removed from the vessel, or relocated on the vessel to bring the vessel to the light ship condition. Each item must be clearly identified by weight and vertical and longitudinal location. If necessary, record also the transverse location. The inclining weights, the pendulums, any temporary equipment and dunnage, and the people on board during the stability test are all among the weights to be removed to obtain the light ship condition. The person calculating the light ship characteristics from the data gathered

during the incline and survey or the person reviewing the stability test, or both, may not have been present during the test and must be able to determine the exact location of the items from the data recorded and the vessel's drawings. Any tanks containing liquids must be accurately sounded and the soundings recorded. Table 1 is an example of just a few typical entries from a survey.

(1) It is recognized that the weight of some items on board, or that are to be added, may have to be estimated. If this is necessary, it is in the best interest of safety to be on the safe side when estimating, so the following rules of thumb should be followed:

- (a) When estimating weights to be added:
 - estimate high for items to be added high in the vessel, and
 - estimate low for items to be added low in the vessel.
- (b) When estimating weights to be removed:
 - estimate low for items to be removed from high in the vessel, and
 - estimate high for items to be removed from low in the vessel.
- (c) When estimating weights to be relocated:
 - estimate high for items to be relocated to a higher point in the vessel,
 - estimate low for items to be relocated to a lower point in the vessel.

8.1.2 Freeboard/Draft Readings:

8.1.2.1 Take freeboard/draft readings to establish the position of the waterline to determine the displacement of the vessel at the time of the stability test. At least five freeboard readings, approximately equally spaced along the length of the

TABLE 1 Typical Survey Entries

Items To Be Removed					
Item	Weight, lb	Vertical Center	Longitudinal Center		
Inclining Weight No. 1	2400	3 ft above main deck	4.5 ft aft frame 50		
Inclining Weight No. 2	2640	3 ft above main deck	frame 50		
Inclining Weight No. 3	2500	3 ft above main deck	4.5 ft forward frame 50		
Inclining Weight No. 4	2350	3 ft above main deck	frame 51		
Two men	370	3 ft above main deck	frame 63		
Two men	370	3 ft above main deck	frame 90		
Pendulum No. 1 (total setup and one man)	240	2.8 ft above bottom at centerline	3 ft forward of aft engine room bulkhead		
Fuel oil tank No. 3P 8 ft 8 in. sounding	A	A	A		
Potable water tk No. 1C 9 ft 3 in. sounding	A	A	A		

Items To Be Added					
Item	Weight, lb	Vertical Center	Longitudinal Center		
Radio	200	5 ft above pilot deck	2 ft aft forward pilot house bulkhead		
Antenna	85	15 ft above top of pilot house	frame 20		
Towing cable	800	2.5 ft above main deck	8 ft forward frame 85		
Rescue boat	120	4 ft above main deck	frame 60		

Items To Be Relocated					
Item	Weight, lb	From		To	
		Vertical	Longitudinal	Vertical	Longitudinal
Liferaft	300	main deck	frame 50	01 deck	frame 65
Fire pump	220	main deck	frame 65	2 ft above shell	frame 40

^A Can be determined later by the naval architect from drawings or sounding tables, or both.

vessel with the foremost and aftermost readings positioned as close as possible to the forward and aft perpendicular, should be taken on each side of the vessel to determine the waterline at the time of the inclining. Only on ships where the vertical location of the draft marks (forward, midship, and aft on both sides) have been confirmed to accurately determine the waterline should draft readings be used in lieu of freeboards. The locations for each freeboard reading should be clearly marked. The longitudinal location along the vessel must be accurately determined and recorded since the (molded) depth at each point will be obtained from the vessel's lines. All freeboard measurements should include a reference note clarifying the inclusion of the coaming in the measurement and the coaming height.

8.1.2.2 Read draft and freeboard readings immediately before or immediately after the inclining test. Weights must be on board and in place and all personnel who will be on board during the test including those who will be stationed to read the pendulums should be on board and in location during these readings. This is particularly important on small vessels. If readings are made after the test, maintain the vessel in the same condition as during the test. For small vessels, it may be necessary to counterbalance the list and trim effects of the freeboard measuring party. When possible, take readings from a small boat.

8.1.2.3 The mooring lines should be slack such that the vessel floats freely. A check should be made that the vessel is not resting on the bottom.

8.1.2.4 Determine the relative density of the flotation water at this time. Take samples from a sufficient depth of the water to ensure a true representation of the flotation water and not merely surface water, which could contain fresh water from run off of rain. Place a hydrometer in a water sample and read and record the relative density. For large vessels, it is recommended that samples of the flotation water be taken forward, midship, and aft and the readings averaged. For small vessels, one sample taken from midships should be sufficient. A conversion table from relative density to specific volume is contained in Annex A3. Take the temperature of the water and correct the measured relative density for deviation from the standard, if necessary. A correction to water relative density is not necessary if the relative density is determined at the inclining experiment site. Correction is necessary if relative density is measured when sample temperature differs from the temperature at the time of the inclining (for example, if check of relative density is done at the office).

8.1.2.5 A small boat should be available to aid in the taking of freeboard and draft mark readings. It should have low freeboard to permit accurate observation of the readings. Photographs may also be taken to document the readings.

8.1.2.6 A draft mark reading may be substituted for a given freeboard reading at that longitudinal location if the height and location of the mark has been verified to be accurate by a keel survey while the vessel was in drydock.

8.1.2.7 A device, such as a draft tube, can be used to improve the accuracy of freeboard/draft readings by damping out wave action.

8.1.2.8 Calculate the mean draft (average of port and starboard reading) for each of the locations where freeboard/draft readings are taken and plotted on the vessel's lines drawing or outboard profile to ensure that all readings are consistent and together define the correct waterline. The resulting plot should yield either a straight line or a waterline which is either hogged or sagged. If inconsistent readings are obtained, retake the freeboards/drafts.

8.1.3 *The Inclining Experiment:*

8.1.3.1 Before any weight movements, check the following:

(1) Check the mooring arrangement to ensure that the vessel is floating freely. (Do this just before each reading of the pendulums.)

(2) Measure the pendulums and record their lengths. The pendulums should be aligned so that when the vessel heels, the wire will be close enough to the batten to ensure an accurate reading but will not come into contact with the batten. The typical satisfactory arrangement is shown in Fig. 15.

(3) Mark the initial position of the weights on the deck. This can be done by tracing the outline of the weights on the deck.

(4) The communications arrangement is adequate.

(5) All personnel are in place.

8.1.3.2 Run a plot during the test to ensure that acceptable data is being obtained.

8.1.3.3 The standard test uses eight weight movements. Movement No. 8, a recheck of the zero point, may be omitted if a straight line plot is achieved after Movement No. 7.

8.1.3.4 The weight movements shown in Fig. 16 give a good spread of points on the test plot.

8.1.3.5 Once everything and everyone is in place, obtain the zero position and conduct the remainder of the experiment as quickly as possible, while maintaining accuracy and proper procedures, to minimize the possibility of a change in environmental conditions during the test.

8.1.3.6 Before each pendulum reading, each pendulum station should report to the control station when the pendulum has

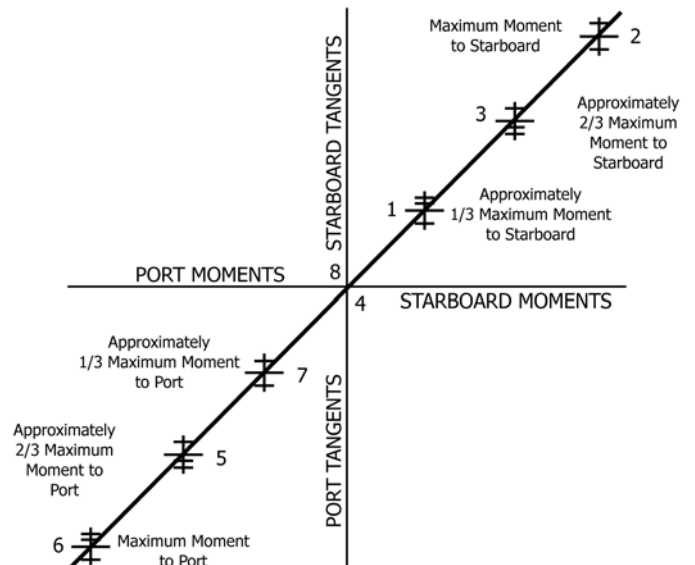

FIG. 16 Acceptable Spread of Test Points On Incline Plot