



Designation: E1077 – 14 (Reapproved 2021)

# Standard Test Methods for Estimating the Depth of Decarburization of Steel Specimens<sup>1</sup>

This standard is issued under the fixed designation E1077; the number immediately following the designation indicates the year of original adoption or, in the case of revision, the year of last revision. A number in parentheses indicates the year of last reapproval. A superscript epsilon ( $\epsilon$ ) indicates an editorial change since the last revision or reapproval.

*This standard has been approved for use by agencies of the U.S. Department of Defense.*

## INTRODUCTION

These test methods may be used to estimate the average or greatest depth of decarburization in hardened or non-hardened steel products. The test methods described range from simple screening tests to more statistically rigorous test methods depending upon the needs of the investigation.

### 1. Scope

1.1 These test methods cover procedures for estimating the depth of decarburization of steels irrespective of the composition, matrix microstructure, or section shape. The following basic procedures may be used:

- 1.1.1 Screening methods.
- 1.1.2 Microscopical methods.
- 1.1.3 Microindentation hardness methods.
- 1.1.4 Chemical analysis methods.

1.2 In case of a dispute, the rigorous quantitative or lineal analysis method (see 7.3.5 and 7.3.6) shall be the referee method. These methods can be employed with any cross-sectional shape. The chemical analytical methods generally reveal a greater depth of decarburization than the microscopical methods but are limited to certain simple shapes and by availability of equipment. These techniques are generally reserved for research studies. The microindentation hardness method is suitable for accurate measurements of hardened structures with relatively homogeneous microstructures.

1.3 The values stated in SI units are to be regarded as standard. No other units of measurement are included in this standard.

1.4 *This standard does not purport to address all of the safety concerns, if any, associated with its use. It is the responsibility of the user of this standard to establish appropriate safety, health, and environmental practices and determine the applicability of regulatory limitations prior to use.*

<sup>1</sup> These test methods are under the jurisdiction of ASTM Committee E04 on Metallography and are the direct responsibility of Subcommittee E04.14 on Quantitative Metallography.

Current edition approved June 1, 2021. Published June 2021. Originally approved in 1985. Last previous edition approved in 2014 as E1077 – 14. DOI: 10.1520/E1077-14R21.

1.5 *This international standard was developed in accordance with internationally recognized principles on standardization established in the Decision on Principles for the Development of International Standards, Guides and Recommendations issued by the World Trade Organization Technical Barriers to Trade (TBT) Committee.*

### 2. Referenced Documents

- 2.1 *ASTM Standards*:<sup>2</sup>
  - A941 Terminology Relating to Steel, Stainless Steel, Related Alloys, and Ferroalloys
  - E3 Guide for Preparation of Metallographic Specimens
  - E7 Terminology Relating to Metallography
  - E340 Practice for Macroetching Metals and Alloys
  - E350 Test Methods for Chemical Analysis of Carbon Steel, Low-Alloy Steel, Silicon Electrical Steel, Ingot Iron, and Wrought Iron
  - E384 Test Method for Microindentation Hardness of Materials
  - E407 Practice for Microetching Metals and Alloys
  - E415 Test Method for Analysis of Carbon and Low-Alloy Steel by Spark Atomic Emission Spectrometry
  - E1951 Guide for Calibrating Reticles and Light Microscope Magnifications

### 3. Terminology

3.1 *Definitions*:

3.1.1 For definitions of terms used in these test methods, see Terminology E7 and Terminology A941.

3.2 *Definitions of Terms Specific to This Standard*:

<sup>2</sup> For referenced ASTM standards, visit the ASTM website, www.astm.org, or contact ASTM Customer Service at service@astm.org. For *Annual Book of ASTM Standards* volume information, refer to the standard's Document Summary page on the ASTM website.

3.2.1 *average depth of decarburization*—the mean value of five or more measurements of the total depth of decarburization.

3.2.2 *average free-ferrite depth*—the mean value of five or more measurements of the depth of complete decarburization.

3.2.3 *complete decarburization*—loss of carbon content at the surface of a steel specimen to a level below the solubility limit of carbon in ferrite so that only ferrite is present.

3.2.4 *free-ferrite depth*—the perpendicular distance from the surface of the specimen to that location where the structure is no longer fully ferritic, that is, other transformation products are observed.

NOTE 1—The term *free ferrite* has also been used to describe globular, isolated grains of proeutectoid ferrite in the microstructure of medium-carbon hypoeutectoid steels.

3.2.5 *maximum depth of decarburization*—the largest measured value of the total depth of decarburization.

3.2.6 *partial decarburization*—loss of carbon content at the surface of a steel specimen to a level less than the bulk carbon content of the unaffected interior but greater than the room temperature solubility limit of carbon in ferrite.

3.2.7 *total depth of decarburization*—the perpendicular distance from the specimen surface to that location in the interior where the bulk carbon content is reached; that is, the sum of the depths of complete and partial decarburization.

#### 4. Summary of Test Method

4.1 These test methods are designed to detect changes in the microstructure, hardness, or carbon content at the surface of steel sections due to decarburization. The depth of decarburization is determined as the depth where a uniform microstructure, hardness, or carbon content, typical of the interior of the specimen, is observed.

#### 5. Significance and Use

5.1 These test methods are used to detect surface losses in carbon content due to heating at elevated temperatures, as in hot working or heat treatment.

5.2 Results of such tests may be used to qualify material for shipment according to agreed upon guidelines between purchaser and manufacturer, for guidance as to machining allowances, or to assess the influence of processing upon decarburization tendency.

5.3 Screening tests are simple, fast, low-cost tests designed to separate non-decarburized samples from those with appreciable decarburization. Based on the results of such tests, the other procedures may be utilized as applicable.

5.4 Microscopical tests require a metallographically polished cross section to permit reasonably accurate determination of the depth and nature of the decarburization present. Several methods may be employed for estimation of the depth of decarburization. The statistical accuracy of each varies with the amount of effort expended.

5.5 Microindentation hardness methods are employed on polished cross sections and are most suitable for hardened specimens with reasonably uniform microstructures. This pro-

cedure can be used to define the depth to a specific minimum hardness or the depth to a uniform hardness.

5.6 Chemical analytical methods are limited to specimens with simple, uniform shapes and are based on analysis of incremental turnings or after milling at fixed increments.

5.7 Microscopical tests are generally satisfactory for determining the suitability of material for intended use, specification acceptance, manufacturing control, development, or research.

#### 6. Sampling

6.1 Samples should be taken at locations that are representative of the bulk specimen. The location and number of samples taken depends on the nature of the material to be tested and will be defined upon agreements between manufacturer and purchaser.

6.2 Specimens for screening tests using bulk hardness tests, such as the Rockwell test, should be small enough so that they can be properly supported on the anvil of the tester. The specimen surface should not be altered except for scale removal (if present) using a method that will not alter the subsurface metal.

6.3 Specimens for the microscopical methods or for micro-indentation hardness tests or for macroscopic screening methods should be cut from the bulk specimen perpendicular to the longitudinal axis of the product so that measurements are made on a transverse plane. This procedure permits determination of the variation of decarburization around the periphery of the specimen.

6.3.1 For specimens up to about 2.5-cm diameter, the entire cross section is polished and examined. For larger cross sections, one or more specimens shall be prepared to assess variations in surface decarburization. Figs. 1-3 show examples of typical sampling schemes that may be used for larger sections; the sampling scheme for large sections should be determined upon mutual agreement between manufacturer and purchaser.

6.4 Specimens for chemical analytical methods must be of sufficient length so that the weight of incremental turnings is adequate for chemical analysis or the size of milled surfaces is large enough for sparking yet small enough to fit in the specimen holder.

#### 7. Procedure

##### 7.1 Screening Methods:

7.1.1 *Bulk Surface Hardness*—For hardened specimens, particularly those in the as-quenched condition, a short section of the material to be heat treated is cut and heat treated in the same manner, or along with, the material of interest. The test specimen, however is not tempered. Any scale on the test piece is removed by wire brushing, glass-bead blasting, etc., and hardness tested, usually with the Rockwell C scale. The presence of decarburization is indicated by the difference between the surface hardness and the theoretical maximum hardness for the carbon content of the steel. This method is most suitable for those steels with bulk carbon contents below about 0.55 % carbon but will detect gross decarburization in steels with higher bulk carbon contents. The method is not

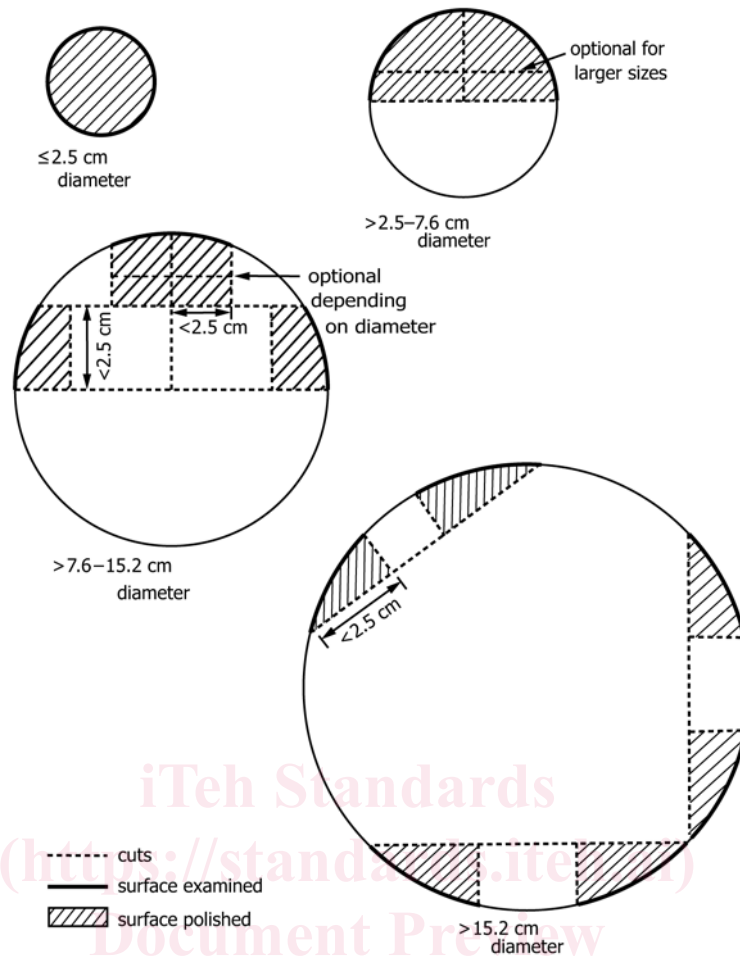

FIG. 1 Typical Sampling Schemes for Round Bars of Different Size

ASTM E1077-14(2021)

suitable for steels that cannot be quench-hardened, for example, low-carbon steels.

**7.1.2 Macroscopical Etch Appearance**—The presence of decarburization is indicated by a difference in etching contrast between the surface and the interior of the specimen. A transverse section can be ground and macroetched or polished and microetched. The method is suitable for as-rolled, as-forged, annealed, normalized, or heat-treated specimens. The decarburized surface layer, if present, usually exhibits a light-etching appearance. Suitable macroetchants are listed in Test Method E340.

**7.2 Microscopical Methods:**

**7.2.1** Microscopical methods are most suitable for measuring the depth of decarburization of as-hot rolled, as-forged, annealed, or normalized specimens. These methods can also be applied to heat-treated specimens, although with less certainty in determining the maximum affected depth. Spheroidize-annealed or cold-worked specimens can also be evaluated; but, detection of structural variations due to decarburization is more difficult than with hot-worked or fully annealed structures.

**7.2.2** Measurement of the depth of decarburization is based on evaluation of the variation in microstructure at the surface due to the change in carbon content. The depth of complete decarburization is easiest to assess due to the excellent contrast

between the free-ferrite layer, when present, and the interior structure. The depth of partial decarburization can best be assessed when this zone contains ferrite and pearlite. If the specimen has been spheroidized, the variation in carbide content in the partially decarburized zone is used to assess the total depth of decarburization. For heat-treated specimens, the presence of non-martensitic structures in the partially decarburized zone is used to estimate the total depth of decarburization. Such measurements will generally underestimate the total depth of decarburization. For certain highalloy spheroidize-annealed tool steels, the depth of decarburization can be estimated by changes in the etch color. For austenitic manganese steels in the solution-annealed condition, depths corresponding to certain carbon contents can be defined by changes in the microstructure due to decarburization. Examples of decarburization for as-rolled, heat treated, and spheroidize-annealed steels are shown in Figs. 4-9, respectively.

**7.2.3** Specimen polishing must be conducted in a manner that does not produce edge rounding. Unmounted, unprotected specimens can be satisfactorily prepared using certain automatic polishing devices. Low-nap cloths should be employed; polishing with abrasives finer than 1- $\mu\text{m}$  diamond is often unnecessary. When such devices are not available, or when

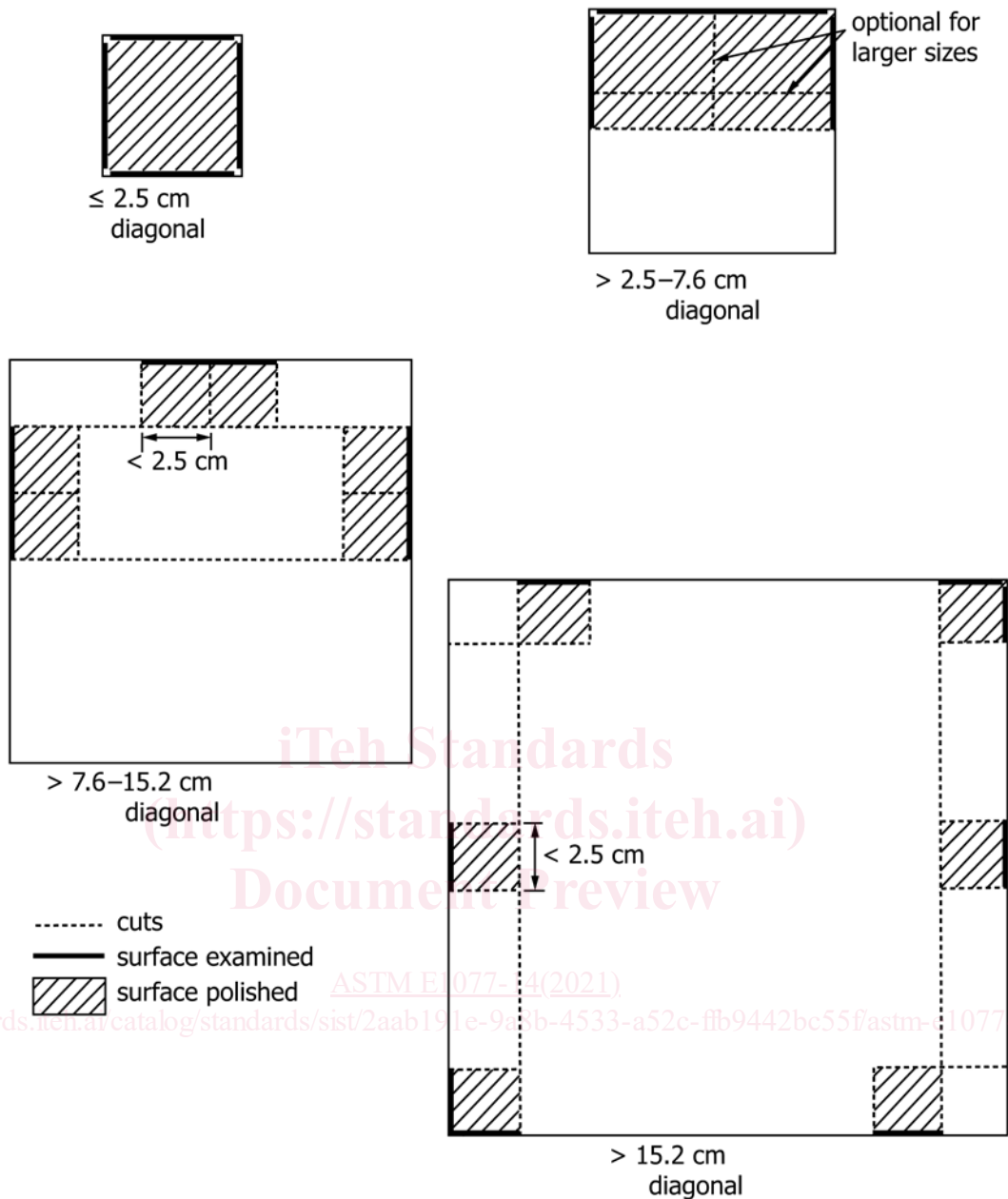

FIG. 2 Typical Sampling Schemes for Square Bars of Different Size

specimens are small or of an inconvenient shape for such devices, specimens should be mounted in clamps or in various plastic media. With some mounting media, edge preservation may be inadequate. The compression mounting epoxy materials generally provide the best edge retention of the commonly available plastics. Electrolytic or electroless plating provides optimum edge retention and is recommended for critical work. Polishing must be practiced using techniques that produce a true representation of the surface microstructure, as described in Guide E3.

7.2.4 Etching should be conducted using standard etchants, (see Test Methods E407) such as nital or picral, based on the experience of the rater with the material being tested. Special

etchants can be used if dictated by the situation encountered. In such cases, agreement should be obtained between manufacturer and purchaser.

7.2.5 For solution-annealed austenitic manganese steels, epsilon martensite will be present in the surface region where the carbon content is below about 0.5 % carbon. This structure is best revealed by etching first with 2 % nital for 5 s and then with 20 % aqueous sodium metabisulphite for about 20 s. After measurement of the depth of this layer, the specimen can be aged at about 560 °C for 1 h to precipitate pearlite at the grain boundaries in the core region where the carbon content is

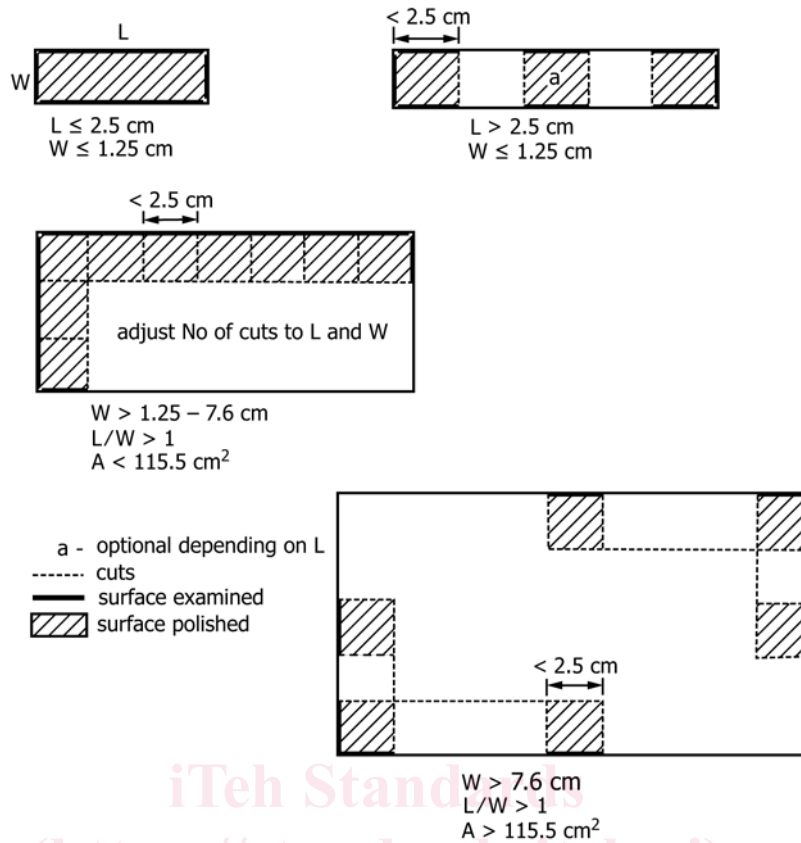

FIG. 3 Typical Sampling Schemes for Flat and Rectangular Bars of Different Size

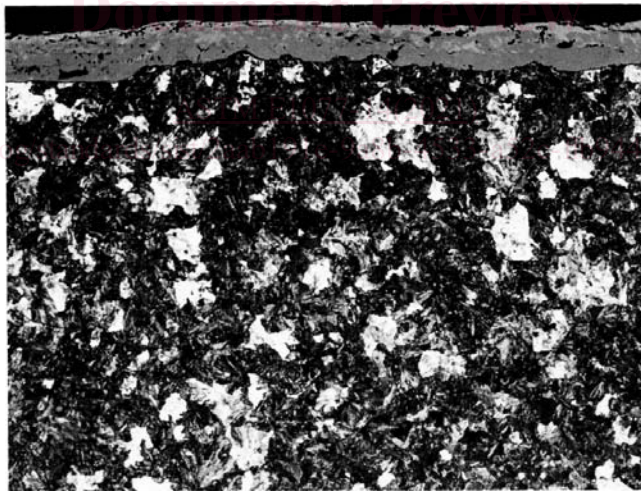

FIG. 4 Example of an As-Rolled, Fully Pearlitic Alloy Steel Microstructure With No Apparent Decarburization. Dark Layer at Surface Is Iron Oxide (Mill Scale) (200x, 2 % Nital Etch)

above 1.16 %. Etching with nital or picral will reveal the pearlite.<sup>3</sup> Figs. 10 and 11 illustrates these conditions.

### 7.3 Measurement:

<sup>3</sup> Sedriks, A. J., and Mulhearn, T. O., "Austenitic Manganese Steel: Structure and Properties of Decarburized Layer," *Journal of the Iron and Steel Institute*, Vol 202, November 1964, pp. 907-911.

7.3.1 The depth of complete or partial decarburization, or both, can be assessed in a variety of ways depending on the desired accuracy. Measurements can be made using an ocular

<sup>4</sup> Sedriks, A. J., "Austenitic Manganese Steel: A Technique for Measuring the Extent of Decarburization," *Journal of the Iron and Steel Institute*, Vol 204, February 1966, pp. 142-145.

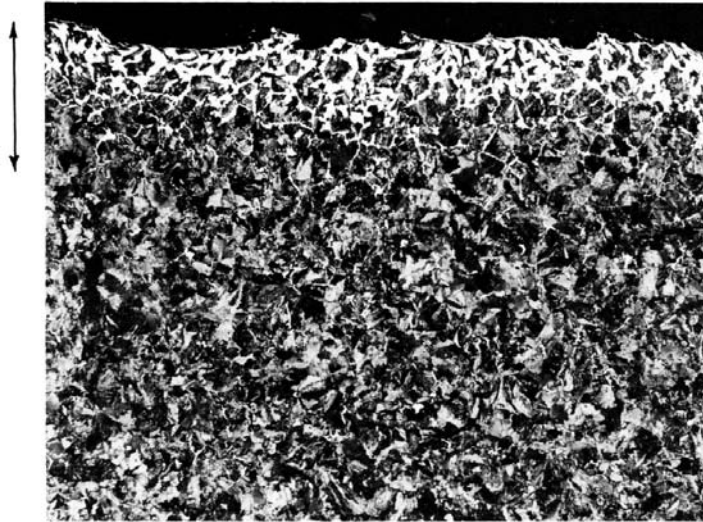

FIG. 5 Example of Partial Decarburization (Note Ferrite At and Near the Surface) in an As-Rolled, Fully Pearlitic Alloy Steel Microstructure (200 $\times$ , 2 % Nital Etch)

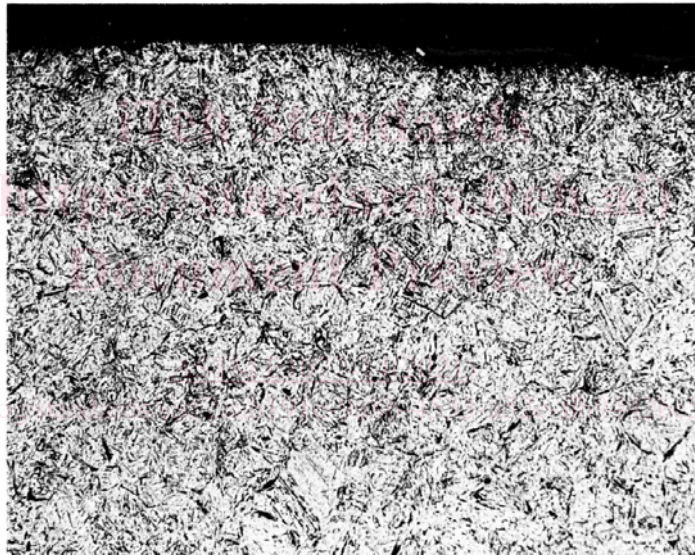

FIG. 6 Example of a Heat-Treated Alloy Steel Microstructure (Fully Martensitic) With No Apparent Decarburization (200 $\times$ , 2 % Nital Etch)

micrometer reticle, a screw (Filar) micrometer ocular, or with a scale placed against a ground-glass projection screen. Measurements can be made on the image or on photographs. Measurements can also be made using image analysis techniques. The accuracy of the measurement device should be established using a stage micrometer. Light microscope calibration procedures can be found in Guide E1951.

7.3.2 The optimum magnification for measurement must be chosen based on the observed structure. It may be helpful to scan the specimen at low magnification for the measurement. The magnification used should be high enough to permit adequate resolution of the structure and achieve the desired measurement precision and avoid bias.

7.3.3 Before performing the measurement, scan the entire specimen surface at a suitable magnification(s) to ensure that the specimen has been properly prepared, to evaluate the

uniformity of the decarburization present, and to assess the nature of the decarburization present, that is, complete and partial or only partial. If complete decarburization (free ferrite) is present, note the continuity of this condition.

7.3.4 The simplest measurement procedure, adequate for many purposes, is to select for measurement those locations on the specimen that appear to represent average and worst conditions of complete and partial decarburization. Measurement of these conditions is made using the devices in 7.3.1. For section shapes that contain corners, decarburization at such locations is not measured unless required. In such cases, it is reported as a separate measurement.

7.3.5 For quality control or research studies, the average depth of decarburization, either complete, partial or total, may be desired but with greater statistical precision. For such cases, the decarburization condition can be measured with greater

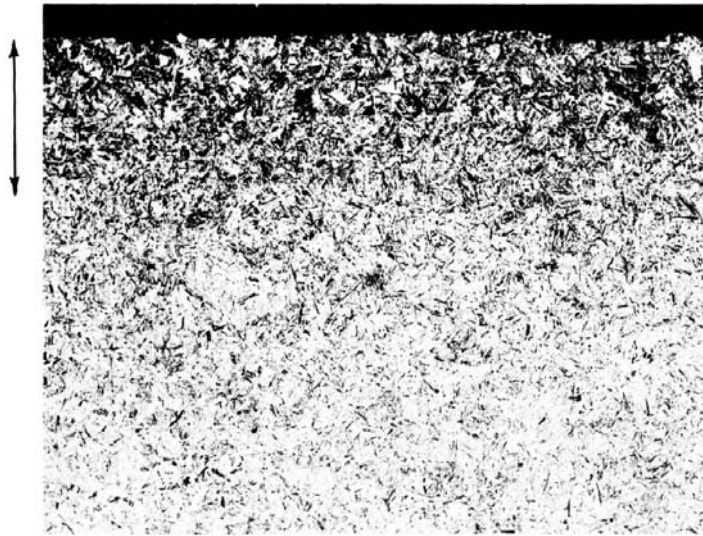

FIG. 7 Example of Partial Decarburization at the Surface of a Heat-Treated Alloy Steel Martensitic Specimen (200x, 2 % Nital Etch)

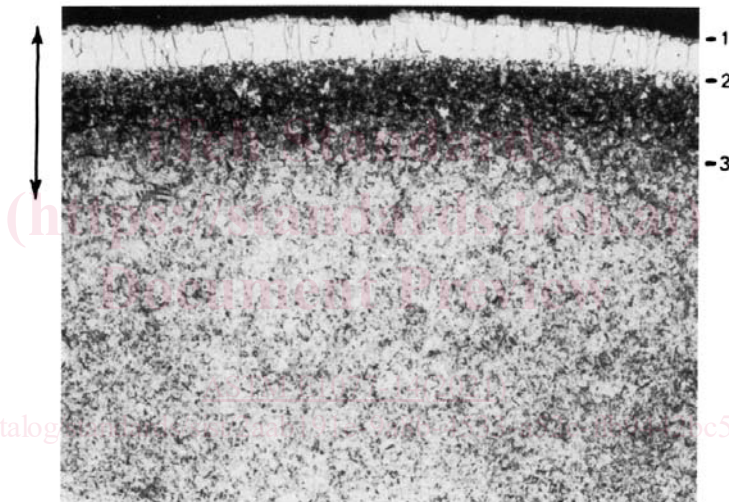

FIG. 8 Example of Complete Decarburization (Free-Ferrite Zone 1 to 2) and Partial Decarburization (Dark Zone 2 to 3) in a Heat-Treated Martensitic Alloy Steel. The Total Depth of Decarburization is the Sum of the Depths of Complete and Partial Decarburization (1 to 3) (200x, 2 % Nital Etch)

statistical definition by making a number of measurements around the specimen periphery at randomly selected locations. The mean, standard deviation, and 95 % confidence limits of such measurements can be calculated. The number of measurements required depends on the size of the specimen and the desired accuracy.

7.3.6 For research studies, the lineal analysis method may be employed to determine the depth at any location where the microstructure becomes uniform and representative of the interior microstructure. Lineal traverses are made at known increments parallel to the surface and the percentage of each constituent present is determined.<sup>5</sup>

<sup>5</sup> Underwood, E. E., *Quantitative Stereology*, Addison-Wesley Publishing Co., Reading, MA, 1970.

7.3.7 If any unusually deep localized penetration of decarburization is observed, such as might be associated with a seam or lap, the depth of decarburization at this imperfection should be measured and reported separately with an explanation of the nature of the condition observed.

7.3.8 For the determination of the depth of decarburization of spheroidized high-alloy tool steels, for example, high-speed steels, the variation in etch color has been utilized. The polished specimen is etched about 60 s with 4 % nital (using methanol) until the surface color is blue-green. The total depth of decarburization is measured as the depth at 100x where the color changes from blue-green to green-tan.<sup>6</sup>

<sup>6</sup> Powell, J. R., "Measurement of a Decarburized Layer on High-Speed Steel," *Metallurgia*, Vol 70, No. 422, December 1964, pp. 295–297.