



# Standard Specification for Drain, Waste, and Vent (DWV) Plastic Fittings Patterns<sup>1</sup>

This standard is issued under the fixed designation D3311; the number immediately following the designation indicates the year of original adoption or, in the case of revision, the year of last revision. A number in parentheses indicates the year of last reapproval. A superscript epsilon ( $\epsilon$ ) indicates an editorial change since the last revision or reapproval.

## 1. Scope\*

1.1 This specification provides standard fitting geometries and laying lengths for plastic fittings intended for use in drain, waste, and vent applications. (See Specifications [D2661](#) and [D2665](#).)

1.2 Fittings meeting the requirements of this standard specification are designed for use with outside diameter controlled pipe. The inside diameter can vary significantly as the wall thickness and outside diameter varies and therefore is not suitable for use as a fitting socket.

1.3 The values stated in inch-pound units are to be regarded as standard. The values given in parentheses are mathematical conversions to SI units that are provided for information only and are not considered standard.

1.4 *This international standard was developed in accordance with internationally recognized principles on standardization established in the Decision on Principles for the Development of International Standards, Guides and Recommendations issued by the World Trade Organization Technical Barriers to Trade (TBT) Committee.*

## 2. Referenced Documents

### 2.1 ASTM Standards:<sup>2</sup>

<sup>1</sup> This specification is under the jurisdiction of ASTM Committee F17 on Plastic Piping Systems and is the direct responsibility of Subcommittee F17.63 on DWV. Current edition approved Nov. 1, 2021. Published December 2021. Originally approved in 1974. Last previous edition approved in 2017 as D3311 – 17. DOI: 10.1520/D3311-17R21.

<sup>2</sup> For referenced ASTM standards, visit the ASTM website, www.astm.org, or contact ASTM Customer Service at service@astm.org. For *Annual Book of ASTM Standards* volume information, refer to the standard's Document Summary page on the ASTM website.

[D2661 Specification for Acrylonitrile-Butadiene-Styrene \(ABS\) Schedule 40 Plastic Drain, Waste, and Vent Pipe and Fittings](#)

[D2665 Specification for Poly\(Vinyl Chloride\) \(PVC\) Plastic Drain, Waste, and Vent Pipe and Fittings](#)

[F1498 Specification for Taper Pipe Threads 60° for Thermoplastic Pipe and Fittings](#)

## 3. Requirements

3.1 Fittings shall conform to the geometries and laying lengths as shown in [Tables 1-45](#) and [Figs. 1-5](#). Tolerances shall be  $\pm 1/16$  in. unless otherwise specified.

3.2 Spigot and hub dimensions shall conform to the requirements of the referencing standard.

3.3 The exact outside shape of a fitting is not determined by the outline drawings shown in this specification but rather by the socket dimensions, wall thickness requirements, waterway, laying lengths, and any other critical dimensions that may be specified.

3.4 The pitch of sockets for patterns with 90° angles (except vent fittings) shall be 1/4 in./ft or 1° 12 min.

3.5 On double reducing sanitary tees, the *G2* dimension on branches will be calculated on the larger size and centerlines shall remain the same for both branches.

3.6 All other dimensions, materials and property requirements shall be in conformance with the referencing standard.

## 4. Keywords

4.1 DWV; fittings; plastic; Schedule 40; thermoplastic

\*A Summary of Changes section appears at the end of this standard

TABLE 1 Bends, in. (mm)

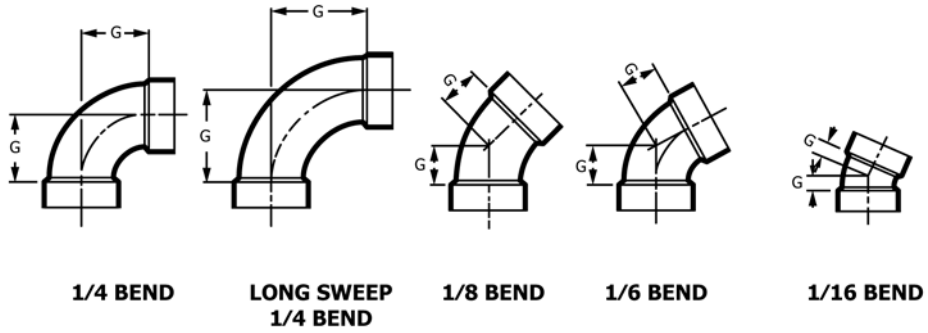

Nominal Pipe Size	1/4 Bend	Long Sweep 1/4 Bend	1/8 Bend	1/6 Bend	1/16 Bend
	G	G	G	G	G
1 1/4	1 9/16 (40)	2 1/4 (57)	1 (25)	7/8 (22)	7/16 (11)
1 1/2	1 3/4 (44)	2 3/4 (70)	1 1/8 (29)	1 (25)	1/2 (13)
2	2 5/16 (59)	3 1/4 (83)	1 1/2 (38)	1 9/16 (33)	1 1/16 (17)
3	3 1/16 (78)	4 1/16 (103)	1 3/4 (44)	1 11/16 (43)	1 3/16 (21)
4	3 7/8 (98)	4 15/16 (125)	2 3/16 (56)	2 1/16 (52)	1 (25)
6	5 (min) (127)	9 (229)	2 (min) (51)	3 3/8 (86)	1 1/2 (38)
8	6 (152)	...	2 1/16 (52)	...	1 1/2 (38)
10	9 1/4 (235) <sup>A</sup>	...	2 5/8 (67) <sup>A</sup>	...	2 3/16 (56) <sup>A</sup>
12	10 1 1/16 <sup>A</sup>	...	3 1/8 (79) <sup>A</sup>	...	2 3/8 (60) <sup>A</sup>

<sup>A</sup> 10 in. and 12 in. fittings dimensions are minimum

TABLE 2 Bends with Inlets, in. (mm)

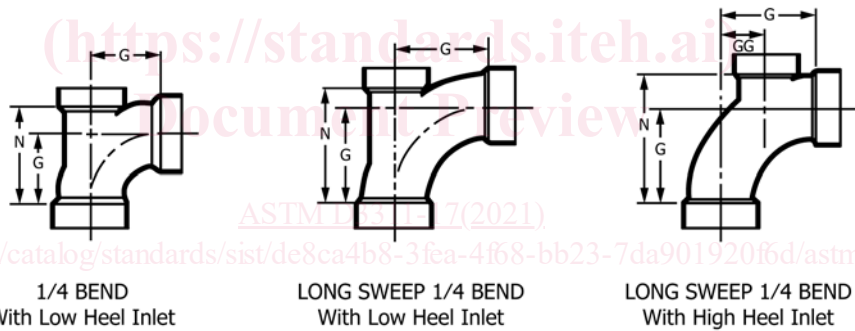

Nominal Pipe Size	1/4 Bend with Low Heel Inlet		Long-Sweep 1/4 Bend with Low Heel Inlet		Long-Sweep 1/4 Bend with High Heel Inlet		
	G	N	G	N	G	N	GG
3 by 3 by 1 1/2	3 1/16 (78)	4 3/16 (106)	4 1/16 (103)	4 3/4 (121)	...	...	...
3 by 3 by 2	3 1/16 (78)	4 7/16 (113)	4 1/16 (103)	4 15/16 (125)	4 1/16 (103)	5 5/8 (143)	2 1/4 (57)
4 by 4 by 2	3 7/8 (98)	5 7/16 (138)	4 15/16 (125)	6 (152)	...	...	...

TABLE 3 Sanitary Tees, 45° Wyes, Combination Wyes and 1/8 Bends, in. (mm)

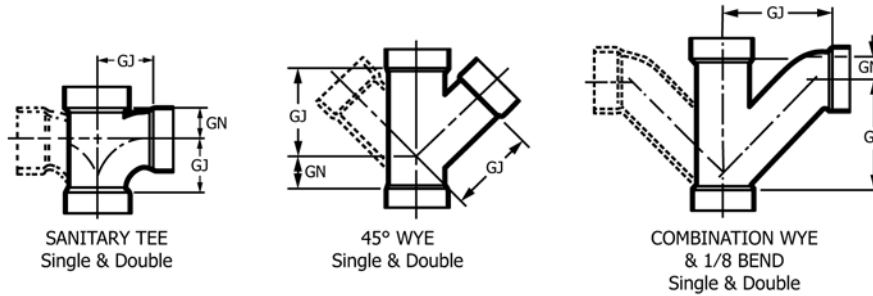

Nominal Pipe Size	Sanitary Tee Single and Double <sup>A</sup>		45° Wye, Single and Double		Combination Wye and 1/8 Bend Single and Double	
	GN	GJ	GN	GJ	GN	GJ
1¼	¾ (19)	1½ (40)	1¼ (27)	2½ (65)	7/16 (11)	2½ (75)
1½	1 (25)	1¾ (44)	1½ (29)	2¾ (73)	½ (13)	3¾ (86)
2	1¾ (35)	2½ (59)	1¾ (35)	3¾ (92)	1 (25)	4½ (114)
3	1¾ (46)	3½ (78)	1¾ (41)	5 (127)	1½ (29)	6½ (160)
4	2¼ (57)	3¾ (98)	1¾ (48) <sup>D</sup>	6¾ (162)	1¾ (46)	8½ (219)
6	3½ (89)	5 (127)	1¾ (44)	8¾ (214)	B	B
8	4½ (114)	6 (152)	2¾ (60)	11¾ (298)	B	B
10	5½ (140) <sup>C</sup>	9¼ (246) <sup>C</sup>	2¾ (62) <sup>C</sup>	13 (330) <sup>C</sup>	B	B
12	6¾ (167) <sup>C</sup>	11 (279) <sup>C</sup>	2¾ (73) <sup>C</sup>	15¾ (391) <sup>C</sup>	B	B

<sup>A</sup> Non-reducing double sanitary tees are for vent use only.  
<sup>B</sup> Combination wye and 1/8 bend is assembled from two standard fittings.  
<sup>C</sup> 10 in. and 12 in. fittings dimensions are minimum.  
<sup>D</sup> This dimension is a minimum with no upper maximum limit.

iTech Standards  
 (https://standards.itih.ai)  
 Document Preview

ASTM D3311-17(2021)

<https://standards.itih.ai/catalog/standards/sist/de8ca4b8-3fea-4f68-bb23-7da901920f6d/astm-d3311-172021>

TABLE 4 Reducing Sanitary Tees, 45° Wyes, Combination Wyes, and 1/8 Bends, in. (mm)

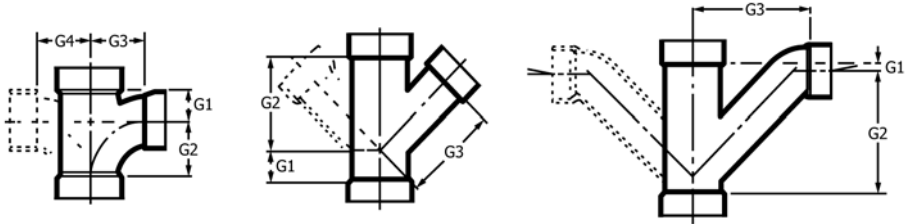

Nominal Pipe Size	Sanitary Tee, Reducing Single and Double <sup>A</sup>				45° Wye, Reducing Single and Double			Combination Wye and 1/8 Bend Reducing Single and Double		
	G1	G2	G3	G4	G1	G2	G3	G1	G2	G3
1 1/2 by 1 1/4 by 1 1/4	1 1/16 (17) <sup>B</sup>	1 1/2 (38) <sup>B</sup>	1 1/16 (43) <sup>B</sup>	1 1/16 (43) <sup>B</sup>	—	—	—	—	—	—
1 1/2 by 1 1/4 by 1 1/2	1 (25)	1 3/4 (44)	1 3/4 (44)	1 3/4 (44)	—	—	—	—	—	—
1 1/2 by 1 1/2 by 1 1/4	1 3/16 (21)	1 11/16 (43)	1 13/16 (46)	1 13/16 (46)	—	—	—	1/2 (13)	3 1/4 (83)	3 3/16 (81)
2 by 1 1/4 by 1 1/2	1 3/16 (30)	1 5/16 (49)	2 3/16 (56)	2 3/16 (56)	—	—	—	—	—	—
2 by 1 1/2 by 1 1/2	1 3/16 (30)	1 5/16 (49)	2 3/16 (56)	2 3/16 (56)	3/4 (19) <sup>B</sup>	2 13/16 (71) <sup>B</sup>	2 15/16 (75) <sup>B</sup>	9/16 (14)	3 11/16 (94)	3 5/8 (92)
2 by 1 1/2 by 2	1 3/8 (35)	2 5/16 (59)	2 5/16 (59)	2 5/16 (59)	1 (25) <sup>B</sup>	3 1/2 (89) <sup>B</sup>	3 3/8 (86) <sup>B</sup>	1 (25)	4 1/2 (114)	4 1/2 (114)
2 by 2 by 1 1/4	1 3/16 (30)	1 5/16 (49)	2 3/16 (56)	2 3/16 (56)	—	—	—	—	—	—
2 by 2 by 1 1/2	1 3/16 (30)	1 5/16 (49)	2 3/16 (56)	2 3/16 (56)	1 1/16 (27)	3 5/16 (84)	3 7/16 (87)	9/16 (14)	3 11/16 (170)	3 5/8 (92)
3 by 3 by 1 1/2	1 5/16 (24)	1 3/4 (44)	2 9/16 (65)	2 9/16 (65)	1/2 (13)	3 3/4 (95)	4 5/16 (110)	1/8 (3)	3 7/16 (87)	4 1/4 (108)
3 by 3 by 2	1 3/16 (30)	2 1/8 (54)	2 7/8 (73)	2 7/8 (73)	7/8 (22)	4 1/8 (105)	4 5/8 (117)	7/16 (11)	4 3/4 (121)	5 9/16 (135)
3 by 3 by 2 by 1 1/2	1 5/16 (24) <sup>B</sup>	2 1/16 (52) <sup>B</sup>	2 7/16 (62) <sup>B</sup>	2 1/2 (64) <sup>B</sup>	—	—	—	—	—	—
4 by 4 by 1 1/2	1 1/16 (27) <sup>B</sup>	2 (51) <sup>B</sup>	3 1/4 (83) <sup>B</sup>	3 1/4 (83) <sup>B</sup>	0 (0) <sup>B</sup>	3 5/16 (84) <sup>B</sup>	3 15/16 (100) <sup>B</sup>	—	—	—
4 by 4 by 2	1 1/8 (29)	2 1/16 (52)	3 5/16 (84)	3 5/16 (84)	3/8 (10)	4 11/16 (119)	5 9/16 (141)	5/16 (8)	4 3/4 (121)	5 7/8 (149)
4 by 4 by 3	1 3/4 (44)	3 (76)	3 9/16 (90)	3 9/16 (90)	1 1/16 (27) <sup>B</sup>	5 9/16 (141) <sup>B</sup>	6 (152) <sup>B</sup>	1 1/16 (27)	6 3/8 (162)	6 7/8 (175)
6 by 6 by 3	—	—	—	—	3/16 (5) <sup>B</sup>	6 15/16 (176) <sup>B</sup>	7 7/16 (189) <sup>B</sup>	1 1/16 (17) <sup>B</sup>	7 13/16 (198) <sup>B</sup>	8 13/16 (224) <sup>B</sup>
6 by 6 by 4	2 3/16 (56) <sup>B</sup>	3 5/8 (92) <sup>B</sup>	4 5/16 (110) <sup>B</sup>	4 5/16 (110) <sup>B</sup>	3/16 (5) <sup>B</sup>	6 11/16 (170) <sup>B</sup>	7 7/16 (189) <sup>B</sup>	9/16 (14) <sup>B</sup>	7 13/16 (198) <sup>B</sup>	8 15/16 (227) <sup>B</sup>
8 by 8 by 4	2 5/8 (67)	4 1/8 (105)	5 1/4 (133)	5 1/4 (133)	3/8 (10)	7 5/8 (194)	8 5/8 (219)	c	c	c
8 by 8 by 6	3 9/16 (90)	4 13/16 (122)	5 1/2 (140)	5 1/2 (140)	1 (25)	9 1/2 (241)	9 13/16 (249)	c	c	c
10 by 10 by 4	...	...	...	...	-1 1/2 (-38) <sup>B</sup>	8 11/16 (221) <sup>B</sup>	10 3/8 (264) <sup>B</sup>	c	c	c
10 by 10 by 6	...	...	...	...	0	10 1/8 (257) <sup>B</sup>	11 1/4 (286) <sup>B</sup>	c	c	c
10 by 10 by 8	...	...	...	...	1 1/4 (32) <sup>B</sup>	11 1/2 (292) <sup>B</sup>	12 7/16 (316) <sup>B</sup>	c	c	c
12 by 12 by 4	...	...	...	...	-2 7/16 (-62) <sup>B</sup>	9 3/4 (248) <sup>B</sup>	11 13/16 (284) <sup>B</sup>	c	c	c
12 by 12 by 6	...	...	...	...	-3/4 (-19) <sup>B</sup>	11 3/16 (284) <sup>B</sup>	11 11/16 (297) <sup>B</sup>	c	c	c
12 by 12 by 8	...	...	...	...	1/2 (13) <sup>B</sup>	12 9/16 (319) <sup>B</sup>	13 7/8 (352) <sup>B</sup>	c	c	c
12 by 12 by 10	...	...	...	...	1 1/8 (29) <sup>B</sup>	14 (356) <sup>B</sup>	14 15/16 (379) <sup>B</sup>	c	c	c

<sup>A</sup> Non-reducing double sanitary tees are for vent use only.  
<sup>B</sup> This dimension is a minimum with no upper maximum limit.  
<sup>C</sup> Combination Wye and 1/8 bend is assembled from two standard fittings.

TABLE 5 60° Wyes, Single, and Double, in. (mm)

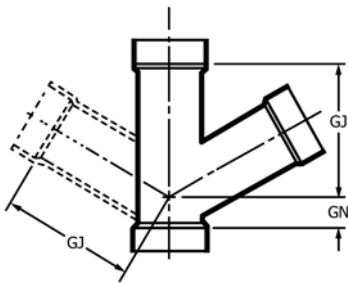

Nominal Pipe Size	GN	GJ
1 1/2	1 1/8 (40)	2 7/8 (73)
2	1 3/8 (37)	3 5/8 (92)
3	1 5/8 (37)	5 (127)

TABLE 6 Fixture Tees, in. (mm)

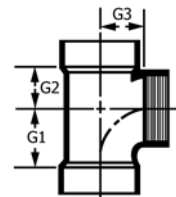

Nominal Pipe Size	G1	G2	G3
1 1/2	1 9/16 (40)	1 3/16 (30)	1 1/4 (32)
2 by 1 1/2 by 1 1/2	1 7/16 (37)	1 3/16 (30)	1 1/4 (32)
2 by 2 by 1 1/2	1 7/16 (37)	1 5/16 (33)	1 1/4 (32)

TABLE 7 Cleanout Tees, in. (mm)

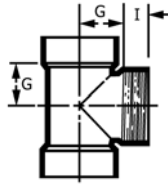

Nominal Pipe Size	G	I
1½	1⅜ (30)	⅝ (16)
2	1½ (38)	⅝ (16)
3	1⅞ (48)	¾ (19)
4	2½ (64)	⅞ (22)
6	3½ (89) <sup>A</sup>	1⅝ (33) <sup>A</sup>
8	4⅞ (102) <sup>A</sup>	1½ (38) <sup>A</sup>

<sup>A</sup> 6 in. and 8 in. fittings dimensions are minimum.

TABLE 8 Reducing Cleanout Tees, in. (mm)

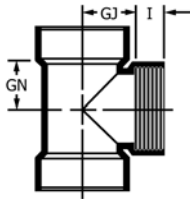

Nominal Pipe Size	GN, min	GJ, min	I, min
10 by 10 by 8	5⅞ (132)	5½ (140)	1¾ (44)
12 by 12 by 8	6 (152)	5½	1⅞ (43)

TABLE 9 60° Reducing Wyes, Single and Double, in. (mm)

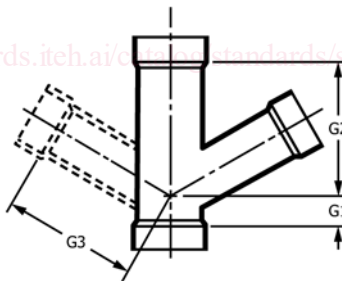

Nominal Pipe Size	G1	G2	G3
2 by 2 by 1½	1⅞ (27)	3⅞ (87)	3⅞ (87)
3 by 3 by 1½	½ (13)	3¾ (95)	4⅞ (110)
3 by 3 by 2	⅞ (22)	4⅞ (105)	4⅞ (117)

TABLE 10 Molded Nipples, in. (mm)

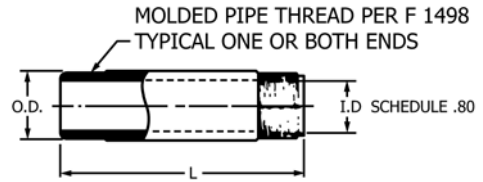

Nominal Pipe Size	OD	ID	Length
1½	1.900	1.500	½-in. increments from close to 18 in. long
2	2.375	1.939	
3	3.500	2.900	

TABLE 11 Vent Tees and ¼ Bend Vents, in. (mm)

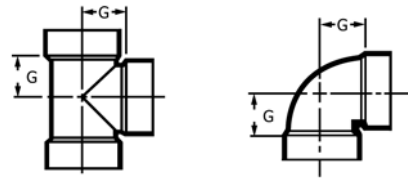

Nominal Pipe Size	Vent Tee	¼ Bend Vent
1¼	1 (25)	1 (25)
1½	1⅜ (30)	1⅜ (30)
2	1½ (38)	1½ (38)
3	1⅞ (48)	1⅞ (48)
4	2½ (64)	2½ (64)
6	3½ (89) <sup>A</sup>	3½ (89) <sup>A</sup>
8	4½ (114) <sup>A</sup>	4½ (89) <sup>A</sup>
10	5⅜ (148) <sup>A</sup>	5⅜ (148) <sup>A</sup>
12	6⅞ (175) <sup>A</sup>	6⅞ (175) <sup>A</sup>

<sup>A</sup> 6 in., 8 in., 10 in., and 12 in. fitting dimensions are minimum.

ASTM D3311-17(2021)

<https://standards.iteh.ai/c.../astm-d3311-172021>

TABLE 12 Reducing Vent Tees, Single, and Double, in. (mm)

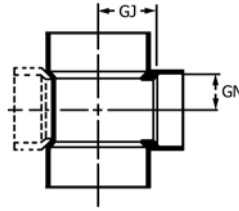

Nominal Pipe Size	GN, min	GJ, min
2 by 1½ by 1½	1¾ (30)	1½ (38)
2 by 2 by 1½	1¾ (30)	1½ (38)
3 by 3 by 1½	1¾ (30)	1⅞ (48)
3 by 3 by 2	1½ (38)	1⅞ (48)
6 by 6 by 4	2½ (64)	3⅞ (87)
8 by 8 by 4	2½ (64)	4½ (114)
8 by 8 by 6	3⅞ (92)	4½ (114)
10 by 10 by 4	3⅞ (92)	5⅞ (149)
10 by 10 by 6	3⅞ (92)	5⅞ (149)
10 by 10 by 8	3½ (89)	5⅞ (149)
12 by 12 by 4	3½ (89)	6⅞ (176)
12 by 12 by 6	4½ (114)	6⅞ (176)
12 by 12 by 8	4⅞ (124)	6⅞ (176)
12 by 12 by 10	6½ (165)	7½ (190)

TABLE 13 Pipe Increasers, in. (mm)



Nominal Pipe Size	N, min
1¼ by 1½	1¾ (30)
1½ by 2	1⅞ (48)
1½ by 3	1¾ (30)
2 by 3	7/8 (22)
2 by 4	1⅞ (48)
3 by 4	1⅞ (48)
3 by 6	1⅞ (48)
4 by 6	1⅞ (48)
4 by 8	1⅞ (48)
4 by 10	2⅞ (72)
6 by 8	¾ (19)
6 by 10	1⅞ (48)
6 by 12	2⅞ (72)
8 by 10	1⅞ (48)
8 by 12	1⅞ (48)
10 by 12	1¼ (32)

TABLE 14 Trap Adapters, in. (mm)

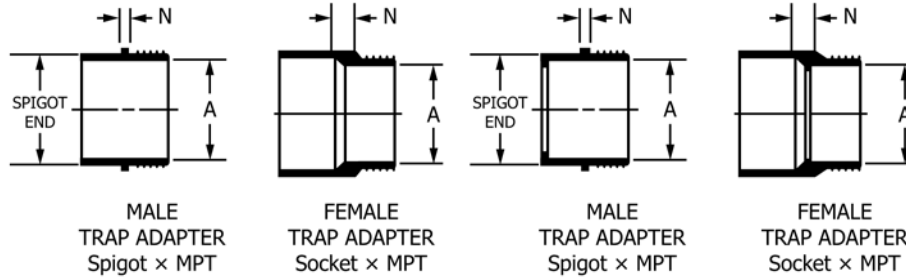

<i>Without Stop</i>			<i>With Stop</i>
Nominal Pipe Size		N, min	A, min
1¼		¾/16 (5)	1.250 (32)
1½		¾/16 (5)	1.500 (38)
2		¾/16 (5)	2.000 (51)
1¼ by 1½		¾/16 (5)	1.250 (32)

TABLE 15 Hubs, in. (mm)

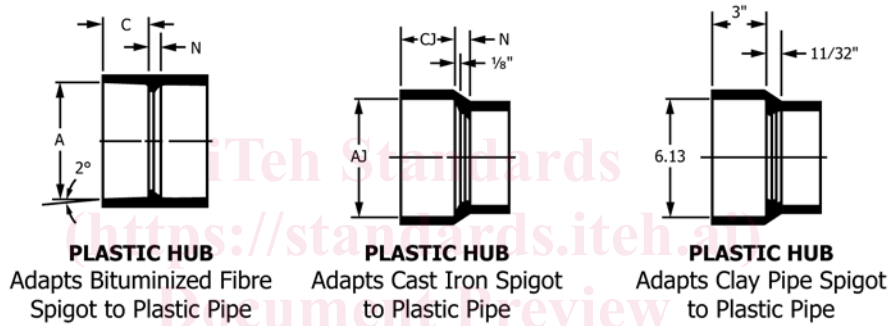

Nominal Pipe Size	A	C	N	AJ	CJ	N
2	...	...	...	2.94 (74.7)	2¾/8 (60)	¾/8 (10)
3	3.448 (87.58)	1¹¹/16 (43)	⁵/16 (8)	3.94 (100.1)	2⁵/8 (67)	⁷/16 (11)
4	4.493 (114.12)	1¹⁵/16 (49)	¹¹/32 (9)	4.94 (125.5)	2⁷/8 (73)	½ (13)
Reducing 4 by 3	4.493 (114.12)	1¹⁵/16 (49)	⁵/16 (8)	4.94 (125.5)	2⁷/8 (73)	⁷/16 (11)

TABLE 16 Spigots, in. (mm)

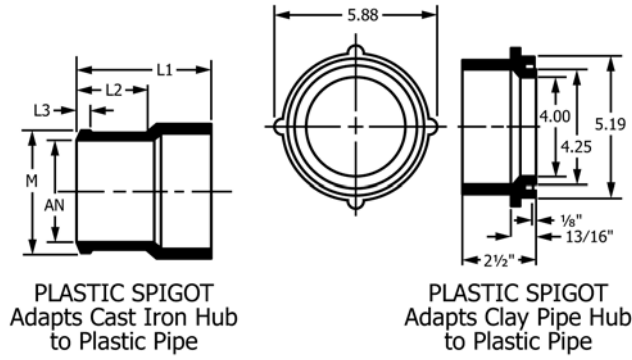

Nominal Pipe Size	L2, min	L1, min	L3, min	M		AN
				max	min	
2	3½ (89)	4½ (117)	¾ (10)	2.75 (69.9)	2.63 (66.8)	2.00 (50.8)
3	3¾ (95)	5½ (143)	¾ (10)	3.88 (98.6)	3.63 (92.2)	3.00 (76.2)
4	4 (102)	6½ (156)	¾ (10)	4.88 (124.0)	4.63 (117.6)	4.00 (101.6)

TABLE 17 Reducing Spigots, in. (mm)

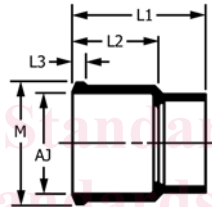

PLASTIC SPIGOT, Reducing Adapts Cast Iron Hub to Plastic Pipe

Nominal Pipe Size	L2 min	L1 min	L3 min	M		AJ
				max	min	
2 by 1½	3½ (89)	4¼ (108)	¾ (10)	2.75 (69.9)	2.63 (66.8)	2.00 (50.8)
3 by 1½	3¾ (95)	4½ (114)	¾ (10)	3.88 (98.6)	3.63 (92.2)	3.00 (76.2)
3 by 2	3¾ (95)	4½ (117)	¾ (10)	3.88 (98.6)	3.63 (92.2)	3.00 (76.2)
4 by 2	4 (102)	4¾ (124)	¾ (10)	4.88 (124.0)	4.63 (117.6)	4.00 (101.6)
4 by 3	4 (102)	5½ (140)	¾ (10)	4.88 (124.0)	4.63 (117.6)	4.00 (101.6)



**ASTM D3311 – 17 (2021)**

**TABLE 18 P Traps, in. (mm)**

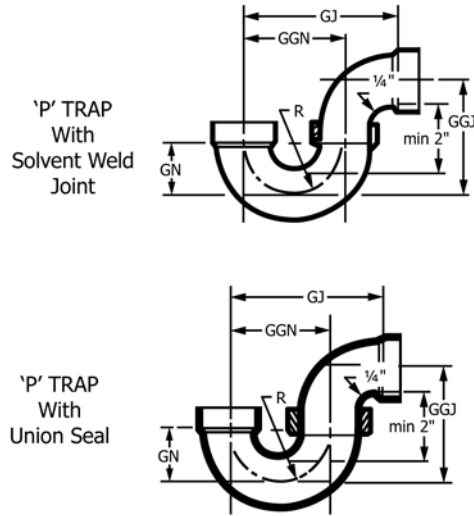

Nominal Pipe Size	min GJ	min GGJ	min GGN	min GN	min R
1¼	4⅞ (105)	3⅞ (86)	3 (76)	1⅜ (35)	1⅝ (41)
1½	4⅞ (107)	3⅞ (92)	3 (76)	1⅜ (35)	1⅝ (41)
2	7¼ (184)	4⅞ (103)	5 (127)	2¼ (57)	2½ (64)
3	8⅞ (214)	6⅞ (160)	6¼ (159)	2⅝ (67)	3⅞ (79)
4	10⅞ (275)	7⅞ (200)	8⅞ (205)	3⅞ (87)	4⅞ (103)
6	17¾ (451)	12¾ (324)	11¾ (298)	4¾ (121)	6⅞ (162)

**TABLE 19 Double Fixture Fitting, in. (mm)**

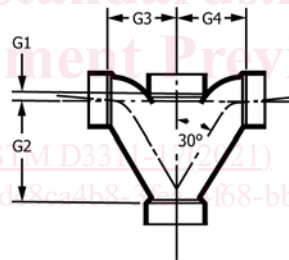

Nominal Pipe Size	G1	G2	G3	G4
1½	⅝ (10)	3⅞ (90)	2⅞ (62)	2⅞ (62)
2	⅝ (10)	4⅞ (116)	3⅞ (78)	3⅞ (78)
3	½ (13)	6¾ (171)	4½ (114)	4½ (114)
Reducing:				
2 by 1½ by 1½ by 1½	⅝ (10)	3⅞ (90)	2⅞ (62)	2⅞ (62)
2 by 1½ by 2 by 2	⅝ (10)	4⅞ (116)	3⅞ (78)	3⅞ (78)
2 by 1½ by 2 by 1½	⅝ (10)	4⅞ (116)	3⅞ (78)	3⅞ (78)

TABLE 20 Double Fixture Fitting, in. (mm)

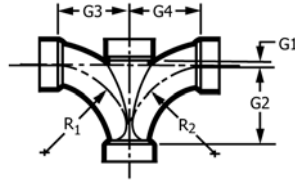

Interchanges with Double Fixture Fittings

Nominal Pipe Size	Double Fixture Fitting					
	G1	G2	G3	G4	R1	R2
1½	¾ (10)	3⅞ (79)	2⅞ (68)	2⅞ (68)	3⅞ (92)	3⅞ (92)
2	¾ (10)	4¼ (108)	3½ (89)	3½ (89)	4½ (114)	4½ (114)
3	½ (13)	6¼ (159)	4⅞ (125)	4⅞ (125)	6⅞ (168)	6⅞ (168)
Reducing						
2 by 1½ by 1½ by 1½	¾ (10)	3⅞ (79)	2⅞ (73)	2⅞ (73)	3⅞ (92)	3⅞ (92)
2 by 1½ by 1½ by 2	¾ (10)	4¼ (108)	2⅞ (73)	3½ (69)	3⅞ (92)	4½ (114)
2 by 1½ by 2 by 2	¾ (10)	4¼ (108)	3½ (89)	3½ (89)	4½ (114)	4½ (114)
3 by 2 by 3 by 3	½ (13)	6¼ (159)	4⅞ (125)	4⅞ (125)	6⅞ (168)	6⅞ (168)

TABLE 21 Single and Double Long Turn Tee, in. (mm)

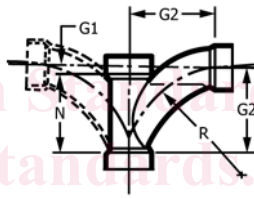

Interchanges with Combination Wye ⅛ Bend

Nominal Pipe Size	Single and Double Long Turn Tee			
	G1	G2	N	R
1¼	¾ (10)	3⅞ (87)	3⅞ (78)	4¾ (121)
1½	¾ (11)	3⅞ (100)	3½ (89)	5⅞ (149)
2	1⅞ (17)	5⅞ (130)	4⅞ (113)	7 (178)
3	1⅞ (27)	7⅞ (192)	6½ (165)	10⅞ (257)
4	1½ (38)	10 (254)	8½ (216)	13¼ (337)
6	2½ (64)	15⅞ (391)	12⅞ (327)	19 (483)

TABLE 22 Single and Double Long Turn Tee Reducing, in. (mm)

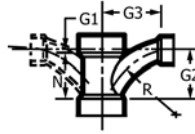

Nominal Pipe Size	Interchanges with Reducing Combination Wye 1/8 Bend				
	Single and Double Long Turn Tee Reducing				
	G1	G3	N	G2	R
1½ by 1¼ by 1¼	¾ (10)	3⅝ (92)	3⅛ (78)	3⅞ (87)	4¾ (121)
1½ by 1½ by 1¼	¾ (10)	3⅝ (92)	3⅛ (78)	3⅞ (87)	4¾ (121)
2 by 1½ by 1½	7⁄16 (11)	4⅜ (107)	3½ (89)	3¹⁵⁄₁₆ (100)	5⅞ (200)
2 by 1½ by 2	1¹⁄₁₆ (17)	5⅞ (130)	4⁷⁄₁₆ (113)	5⅞ (130)	7 (178)
2 by 2 by 1¼	¾ (10)	3¹³⁄₁₆ (97)	3⅛ (78)	3⅞ (87)	4¾ (121)
2 by 2 by 1½	7⁄16 (11)	4⁹⁄₁₆ (102)	3½ (89)	3¹⁵⁄₁₆ (100)	5⅞ (149)
3 by 3 by 1½	7⁄16 (11)	4¾ (121)	3½ (89)	3¹⁵⁄₁₆ (100)	5⅞ (149)
3 by 3 by 2	1¹⁄₁₆ (17)	5¹¹⁄₁₆ (128)	4⁷⁄₁₆ (113)	5⅞ (130)	7 (178)
4 by 4 by 1½	¾ (10)	5⅞ (132)	3⁹⁄₁₆ (90)	3¹⁵⁄₁₆ (100)	5⅞ (149)
4 by 4 by 2	¾ (16)	6⅞ (156)	4½ (114)	5⅞ (130)	7 (178)
4 by 4 by 3	1¹⁄₁₆ (27)	8⅛ (205)	6½ (165)	7⁹⁄₁₆ (192)	10⅞ (257)
6 by 6 by 2	9⁄16 (14)	7⅞ (181)	4⁹⁄₁₆ (116)	5⅞ (130)	7 (178)
6 by 6 by 3	1⁵⁄₁₆ (24)	9¹⁄₁₆ (230)	6⅞ (168)	7⁹⁄₁₆ (192)	10⅞ (257)
6 by 6 by 4	1½ (38)	11 (279)	8½ (216)	10 (254)	13¼ (337)
6 by 6 by 5	2 (51)	13⁵⁄₁₆ (338)	10¾ (273)	12¾ (324)	16 (406)

TABLE 23 Three-Way Ell, in. (mm)

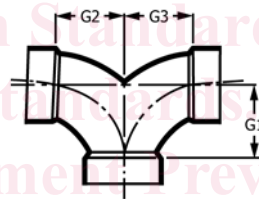

Nominal Pipe Size	G1	G2	G3
1½	1¾ (44)	1¾ (44)	1¾ (44)
2	2⁵⁄₁₆ (59)	2⁵⁄₁₆ (59)	2⁵⁄₁₆ (59)
3	3¼ (78)	3¼ (78)	3¼ (78)
4	3⅞ (98)	3⅞ (98)	3⅞ (98)
Reducing			
2 by 1½ by 1½ (short)	1⅝ (41)	1⅝ (41)	1⅝ (41)
3 by 2 by 3	3¼ (78)	2⅞ (73)	3¼ (78)
2 by 1½ by 1½ (long)	1¹⁵⁄₁₆ (49)	2¾ (56)	2¾ (56)