



Designation: ~~D143 – 21~~ D143 – 22

## Standard Test Methods for Small Clear Specimens of Timber<sup>1</sup>

This standard is issued under the fixed designation D143; the number immediately following the designation indicates the year of original adoption or, in the case of revision, the year of last revision. A number in parentheses indicates the year of last reapproval. A superscript epsilon ( $\epsilon$ ) indicates an editorial change since the last revision or reapproval.

### INTRODUCTION

The need to classify wood species by evaluating the physical and mechanical properties of small clear specimens has always existed. Because of the great variety of species, variability of the material, continually changing conditions of supply, many factors affecting test results, and ease of comparing variables, the need will undoubtedly continue to exist.

In the preparation of these methods for testing small clear specimens, consideration was given both to the desirability of adopting test methods that would yield results comparable to those already available and to the possibility of embodying such improvements as experience has shown desirable. In view of the many thousands of tests made under a single comprehensive plan by the U.S. Forest Service, the former Forest Products Laboratories of Canada (now ~~FP Innovations~~), ~~FP Innovations~~, and other similar organizations, these test methods naturally conform closely to the methods used by those institutions. These test methods are the outgrowth of a study of both American and European experience and methods. The general adoption of these test methods will tend toward a world-wide unification of results, permitting an interchange and correlation of data, and establishing the basis for a cumulative body of fundamental information on the timber species of the world. Many of the figures in this standard use sample data and computation sheets from testing done in the 1950s and earlier. These figures remain in the standard because they are still valid depictions of the recording and plotting of test results and also provide a historical link to the large body of test data on small clear specimens already in existence for this long-standing test method.

Descriptions of some of the strength tests refer to primary methods and secondary methods. Primary methods provide for specimens of 22-in. by 2-in. (50 mm by 50 mm) cross section. This size of specimen has been extensively used for the evaluation of various mechanical and physical properties of different species of wood, and a large number of data based on this primary method have been obtained and published.

The 22-in. by 2-in. (50 mm by 50 mm) size has the advantage in that it embraces a number of growth rings, is less influenced by earlywood and latewood differences than smaller size specimens, and is large enough to represent a considerable portion of the sampled material. It is advisable to use primary method specimens wherever possible. There are circumstances, however, when it is difficult or impossible to obtain clear specimens of 2 by 2-in. cross section having the required 30 in. (760 mm) length for static bending tests. With the increasing incidence of smaller second growth trees, and the desirability in certain situations to evaluate a material which is too small to provide a 22-in. by 2-in. cross section, a secondary method which utilizes a 11-in. by 1-in. (25 mm by 25 mm) cross section has been included. This cross section is established for compression parallel to grain and static bending tests, while the 22-in. by 2-in. cross section is retained for impact bending, compression perpendicular to grain, hardness, shear parallel to grain, cleavage, and tension perpendicular to grain. Toughness and tension parallel to grain are special tests using specimens of smaller cross section.

<sup>1</sup> These test methods are under the jurisdiction of ASTM Committee D07 on Wood and are the direct responsibility of Subcommittee D07.01 on Fundamental Test Methods and Properties.

Current edition approved June 1, 2021; May 15, 2022. Published July 2021; June 2022. Originally approved in 1922. Last previous edition approved in 2014; 2021 as ~~D143 – 14~~; D143 – 21. DOI: ~~10.1520/D0143-21~~; 10.1520/D0143-22.

The user is cautioned that test results between two different sizes of specimens are not necessarily directly comparable. Guidance on the effect of specimen size on a property being evaluated is beyond the scope of these test methods and should be sought elsewhere.

Where the application, measurement, or recording of load and deflection can be accomplished using electronic equipment and computerized apparatus, such devices are encouraged. It is important that all data measurement and recording equipment, whether electronic or mechanical, be accurate and reliable to the degree specified.

**iTeh Standards**  
**(<https://standards.itih.ai>)**  
**Document Preview**

[ASTM D143-22](#)

<https://standards.itih.ai/catalog/standards/sist/2bb7554f-f9b3-47cf-b2c6-7b46f7a42948/astm-d143-22>

## 1. Scope

1.1 These test methods cover the determination of various strength and related properties of wood by testing small clear specimens.

1.1.1 These test methods represent procedures for evaluating the different mechanical and physical properties, controlling factors such as specimen size, moisture content, temperature, and rate of loading.

1.1.2 Sampling and collection of material is discussed in Practice **D5536**. Sample data, computation sheets, and cards have been incorporated, which were of assistance to the investigator in systematizing records.

1.1.3 The values stated in inch-pound units are to be regarded as the standard. The values given in parentheses are mathematical conversions to SI units that are provided for information only and are not considered standard. When a weight is prescribed, the basic inch-pound unit of weight (lbf) and the basic SI unit of mass (Kg) are cited.

1.2 The procedures for the various tests appear in the following order:

|   | Sections |
|---|----------|
| Photographs of Specimens                    | 5        |
| Control of Moisture Content and Temperature | 6        |
| Record of Heartwood and Sapwood             | 7        |
| Static Bending                              | 8        |
| Compression Parallel to Grain               | 9        |
| Impact Bending                              | 10       |
| Toughness                                   | 11       |
| Compression Perpendicular to Grain          | 12       |
| Hardness                                    | 13       |
| Shear Parallel to Grain                     | 14       |
| Cleavage                                    | 15       |
| Tension Parallel to Grain                   | 16       |
| Tension Perpendicular to Grain              | 17       |
| Nail Withdrawal                             | 18       |
| Specific Gravity and Shrinkage in Volume    | 19       |
| Radial and Tangential Shrinkage             | 20       |
| Moisture Determination                      | 21       |
| Permissible Variations                      | 22       |
| Calibration                                 | 23       |

1.3 *This standard does not purport to address all of the safety concerns, if any, associated with its use. It is the responsibility of the user of this standard to establish appropriate safety, health, and environmental practices and determine the applicability of regulatory limitations prior to use.*

1.4 *This international standard was developed in accordance with internationally recognized principles on standardization established in the Decision on Principles for the Development of International Standards, Guides and Recommendations issued by the World Trade Organization Technical Barriers to Trade (TBT) Committee.*

## 2. Referenced Documents

### 2.1 *ASTM Standards:*<sup>2</sup>

[D9 Terminology Relating to Wood and Wood-Based Products](#)

[D198 Test Methods of Static Tests of Lumber in Structural Sizes](#)

[D2395 Test Methods for Density and Specific Gravity \(Relative Density\) of Wood and Wood-Based Materials](#)

[D3043 Test Methods for Structural Panels in Flexure](#)

[D4442 Test Methods for Direct Moisture Content Measurement of Wood and Wood-Based Materials](#)

[D4761 Test Methods for Mechanical Properties of Lumber and Wood-Based Structural Materials](#)

[D5536 Practice for Sampling Forest Trees for Determination of Clear Wood Properties](#)

[E4 Practices for Force Calibration and Verification of Testing Machines](#)

[E2309 Practices for Verification of Displacement Measuring Systems and Devices Used in Material Testing Machines](#)

<sup>2</sup> For referenced ASTM standards, visit the ASTM website, [www.astm.org](http://www.astm.org), or contact ASTM Customer Service at [service@astm.org](mailto:service@astm.org). For *Annual Book of ASTM Standards* volume information, refer to the standard's Document Summary page on the ASTM website.

### 3. Summary of Test Methods

3.1 The mechanical tests are static bending, compression parallel to grain, impact bending toughness, compression perpendicular to grain, hardness, shear parallel to grain, cleavage, tension parallel to grain, tension-perpendicular-to-grain, and nail-withdrawal tests. These tests are permitted for both green and air-dry material as specified in these test methods. In addition, test methods for evaluating such physical properties as specific gravity, shrinkage in volume, radial shrinkage, and tangential shrinkage are presented.

NOTE 1—The test for shearing strength perpendicular to the grain (sometimes termed “vertical shear”) is not included as one of the principal mechanical tests since in such a test the strength is limited by the shearing resistance parallel to the grain.

### 4. Significance and Use

4.1 These test methods cover tests on small clear specimens of wood that are made to provide the following:

4.1.1 Data for comparing the mechanical properties of various species,

4.1.2 Data for the establishment of correct strength functions, which in conjunction with results of tests of timbers in structural sizes (see Test Methods D198 and Test Methods D4761), afford a basis for establishing allowable stresses, and

4.1.3 Data to determine the influence on the mechanical properties of such factors as density, locality of growth, position in cross section, height of timber in the tree, change of properties with seasoning or treatment with chemicals, and change from sapwood to heartwood.

### 5. Photographs of Specimens

5.1 Four of the static bending specimens from each species shall be selected for photographing, as follows: two average growth, one fast growth, and one slow growth. These specimens shall be photographed in cross section and on the radial and tangential surfaces. Fig. 1 is a typical photograph of a cross section of 2-in. by 2-in. (50 mm by 50 mm) test specimens, and Fig. 2 is the tangential surface of such specimens.

### 6. Control of Moisture Content and Temperature

6.1 In recognition of the significant influence of temperature and moisture content on the strength of wood, it is highly desirable that these factors be controlled to ensure comparable test results.

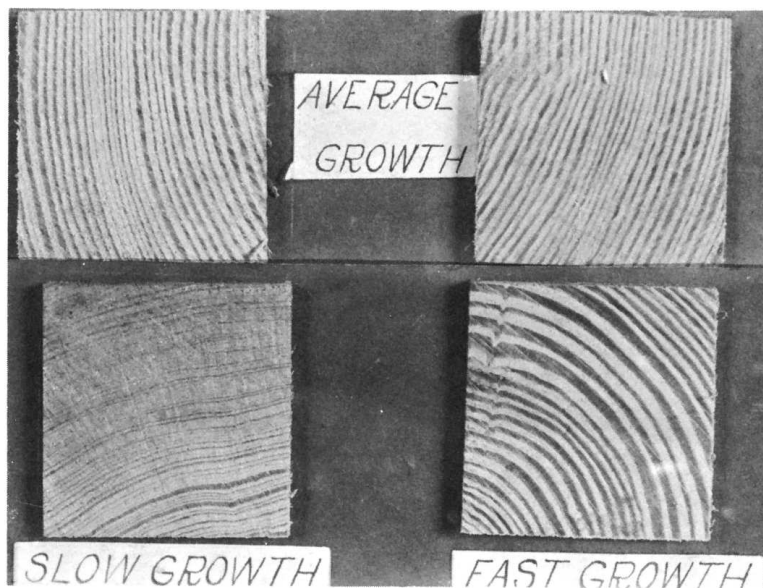

FIG. 1 Cross Sections of Bending Specimens Showing Different Rates of Growth of Longleaf Pine (2-in. by 2-in. (50 mm by 50 mm) Specimens)



**FIG. 2 Tangential Surfaces of Bending Specimens of Different Rates of Growth of Jeffrey Pine 22-in. by 22-in. by 30-in. (50 mm by 50 mm by 760 mm) Specimens**

6.2 *Control of Moisture Content*—Specimens for the test in the air-dry condition shall be dried to approximately constant weight before test. If any changes in moisture content occur during final preparation of specimens, the specimens shall be reconditioned to constant weight before test. Tests shall be carried out in such manner that large changes in moisture content will not occur. To prevent such changes, it is desirable that the testing room and rooms for preparation of test specimens have some means of humidity control.

6.3 *Control of Temperature*—Temperature and relative humidity together affect wood strength by fixing its equilibrium moisture content. The mechanical properties of wood are also affected by temperature alone. When tested, the specimens shall be at a temperature of  $68 \pm 6$  °F ( $20 \pm 3$  °C). The temperature at the time of test shall in all instances be recorded as a specific part of the test record.

## 7. Record of Heartwood and Sapwood

7.1 *Proportion of Sapwood*—If heartwood and sapwood present in the specimen can be distinguished by visual inspection, the proportion of sapwood present shall be estimated as required for the purposes of the test program and recorded for each test specimen.

## 8. Static Bending

8.1 *Size of Specimens*—The static bending tests shall be made on 2 in. by 2 in. by 30 in. (50 mm by 50 mm by 760 mm) primary method specimens or 1 in. by 1 in. by 16 in. (25 mm by 25 mm by 410 mm) secondary method specimens. The actual height and width at the center and the length shall be measured (see 22.2).

8.2 *Loading Span and Supports*—Use center loading and a span length of 28 in. (710 mm) for the primary method and 14 in. (360 mm) for the secondary method. These spans were established in order to maintain a minimum span-to-depth ratio of 14. Both supporting knife edges shall be provided with bearing plates and rollers of such thickness that the distance from the point of support to the central plane is not greater than the depth of the specimen (Fig. 3). The knife edges shall be adjustable laterally to permit adjustment for slight twist in the specimen.

NOTE 2—An example of laterally adjustable supports is provided in Figure 1 of Test Methods D3043.

8.3 *Bearing Block*—A rigid bearing block having a radius of 3 in. (76 mm) and a chord length of not less than  $3\frac{13}{16}$  in. (97 mm) that is fixed from rotation shall be used for applying the load for primary method specimens. An example is provided in Fig. 4. A similar block having a radius of  $1\frac{1}{2}$  in. (38 mm) for a chord length of not less than 2 in. (50 mm) shall be used for secondary method specimens. The bearing block shall be fabricated with a material that will not appreciably deform under load.

8.4 *Placement of Growth Rings*—The specimen shall be placed so that the load will be applied through the bearing block to the tangential surface nearest the pith.

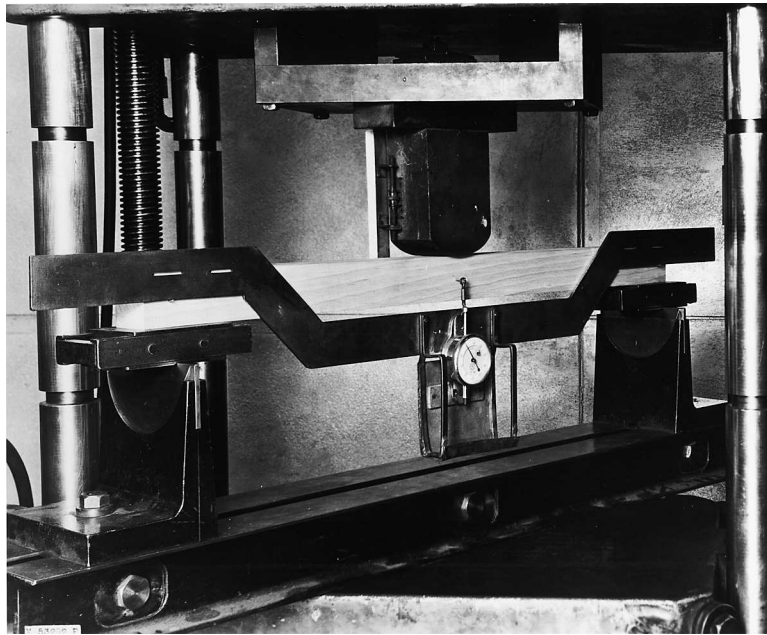

FIG. 3 Static Bending Test Assembly Showing Test Method of Load Application, Specimen Supported on Rollers and Laterally Adjustable Knife Edges, and Test Method of Measuring Deflection at Neutral Axis by Means of Yoke and Displacement Measurement Device

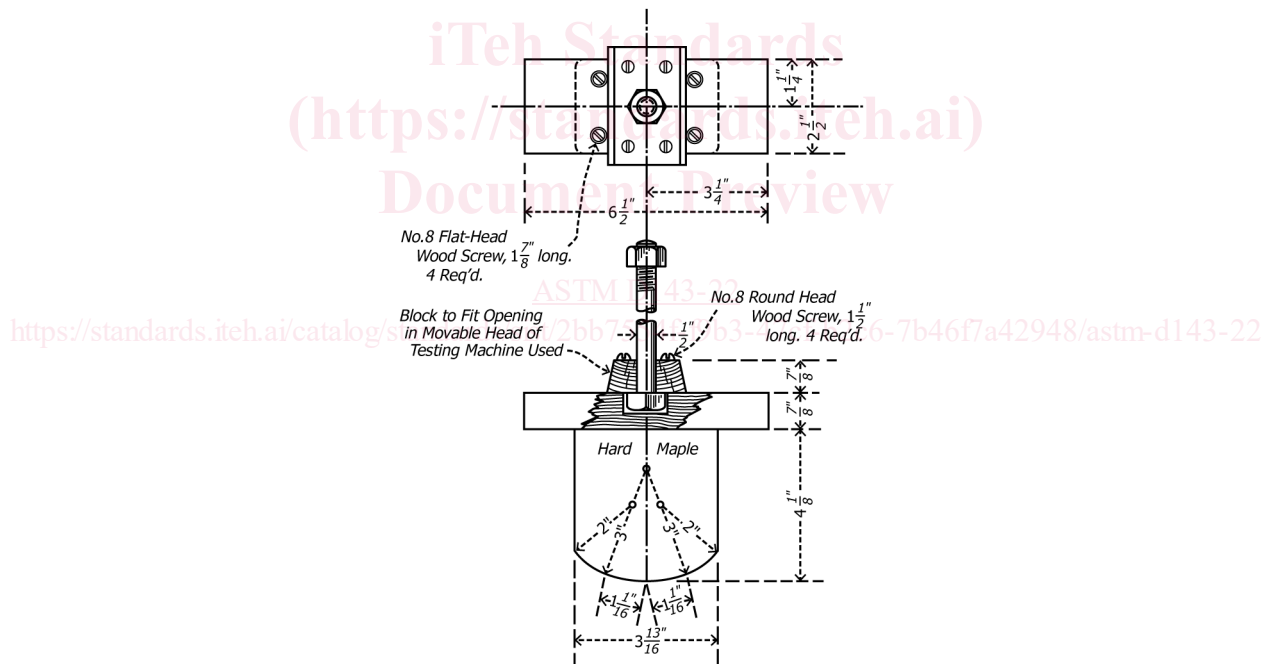

FIG. 4 Example of a Bearing Block for Static Bending Tests

8.5 *Speed of Testing*—The load shall be applied continuously throughout the test at a rate of motion of the movable crosshead of 0.10 in. (2.5 mm)/min, for primary method specimens, and at a rate of 0.05 in. (1.3 mm)/min for secondary method specimens (see 22.3).

8.6 *Load-Deflection Curves:*

8.6.1 At a minimum, the load-deflection curves shall be recorded and the test continued up to the maximum load for all static bending tests. If required for the purposes of the study, it shall be permitted to continue both loading and the load-deflection measurement beyond the maximum load.

NOTE 3—One situation where the user may choose to continue the test and the load-deflection measurements beyond the maximum load is if the total energy under the flexural load-deflection curve is a parameter of concern. In these instances for primary method specimens, it has been customary to continue the test and record the load-deflection curve beyond the maximum load to a 6 in. (152 mm) deflection or until the specimen fails to support a load of 200 lbf (890 N). For secondary method specimens, it has been customary to continue loading to a 3 in. (76 mm) deflection, or until the specimen fails to support a load of 50 lbf (222 N).

8.6.2 Deflections of the neutral plane at the center of the length shall be taken with respect to points in the neutral plane above the supports. Alternatively, deflection shall be permitted to be taken relative to the tension surface at midspan, provided that vertical displacements which occur at the reactions are taken into account.

8.6.3 Within the proportional limit, deflection readings shall be taken with a yoke-mounted displacement measurement device capable of at least a Class B rating when evaluated in accordance with Practice E2309. After the proportional limit is reached, less refinement is necessary in observing deflections. It shall be permissible to continue the deflection measurement beyond the proportional limit using an alternative means of deflection measurement capable of at least a Class C rating when evaluated in accordance with Practice E2309. To characterize the load-deflection curve, the load and deflection shall be measured and recorded at a maximum interval spacing of 0.10 in. (2.5 mm) and after abrupt changes in load. Continuous load and deflection data acquisition is preferred.

8.6.4 When data are recorded manually, the load and deflection of the first failure, the maximum load, and points of sudden change shall be read and shown on the curve sheet, even if they do not occur at one of the regular load or deflection increments. When data are recorded electronically, the data recording rate shall be sufficient to capture the same points so that they can be similarly reported.

NOTE 4—See Fig. 5 for a sample static bending data sheet form.

8.7 *Description of Failure*—Static bending (flexural) failures shall be classified in accordance with the appearance of the fractured surface and the manner in which the failure develops (Fig. 6). Where appropriate, the fractured surfaces shall be roughly divided into “brash” and “fibrous”, the term “brash” indicating abrupt failure and “fibrous” indicating a fracture showing splinters. Each type of observed failure mode shall be photographed or sketched.

8.8 *Weight and Moisture Content*—The specimen shall be weighed immediately before test, and after the test a moisture section approximately 1 in. (25 mm) in length shall be cut from the specimen near the point of failure (see 21.1 and 22.1).

## 9. Compression Parallel to Grain

9.1 *Size of Specimens*—The compression-parallel-to-grain tests shall be made on 2 in. by 2 in. by 8 in. (50 mm by 50 mm by 200 mm) primary method specimens, or 1 by 1 by 4 in. (25 by 25 by 100 mm) secondary method specimens. The actual cross-sectional dimensions and the length shall be measured (see 22.2).

9.2 *End Surfaces Parallel*—Special care shall be used in preparing the compression-parallel-to-grain test specimens to ensure that the end grain surfaces will be parallel to each other and at right angles to the longitudinal axis. At least one platen of the testing machine shall be equipped with a spherical bearing to obtain uniform distribution of load over the ends of the specimen.

9.3 *Speed of Testing*—The load shall be applied continuously throughout the test at a rate of motion of the movable crosshead of 0.003 in./in. (mm/mm) of nominal specimen length/min (see 22.3).

### 9.4 *Load-Compression Curves:*

9.4.1 Load-compression curves shall be taken over a central gage length not exceeding 6 in. (150 mm) for primary method specimens, and 2 in. (50 mm) for secondary method specimens. Load-compression readings shall be continued until the proportional limit is well passed, as indicated by the curve.

NOTE 5—See Fig. 7 for a sample compression-parallel-to-grain data sheet form.

FILE NO. 124  
 COST CHARGE \_\_\_\_\_  
 LABORATORY NO. 100,831

U. S. DEPARTMENT OF AGRICULTURE  
 FOREST SERVICE

STATION - MADISON DATE - AUG. 24, 1914 SHIP. NO. L-315 STICK NO. S-8  
 PIECE NO. 4 MARK d

MEASURED \_\_\_\_\_  
 TESTED \_\_\_\_\_  
 WEIGHED \_\_\_\_\_

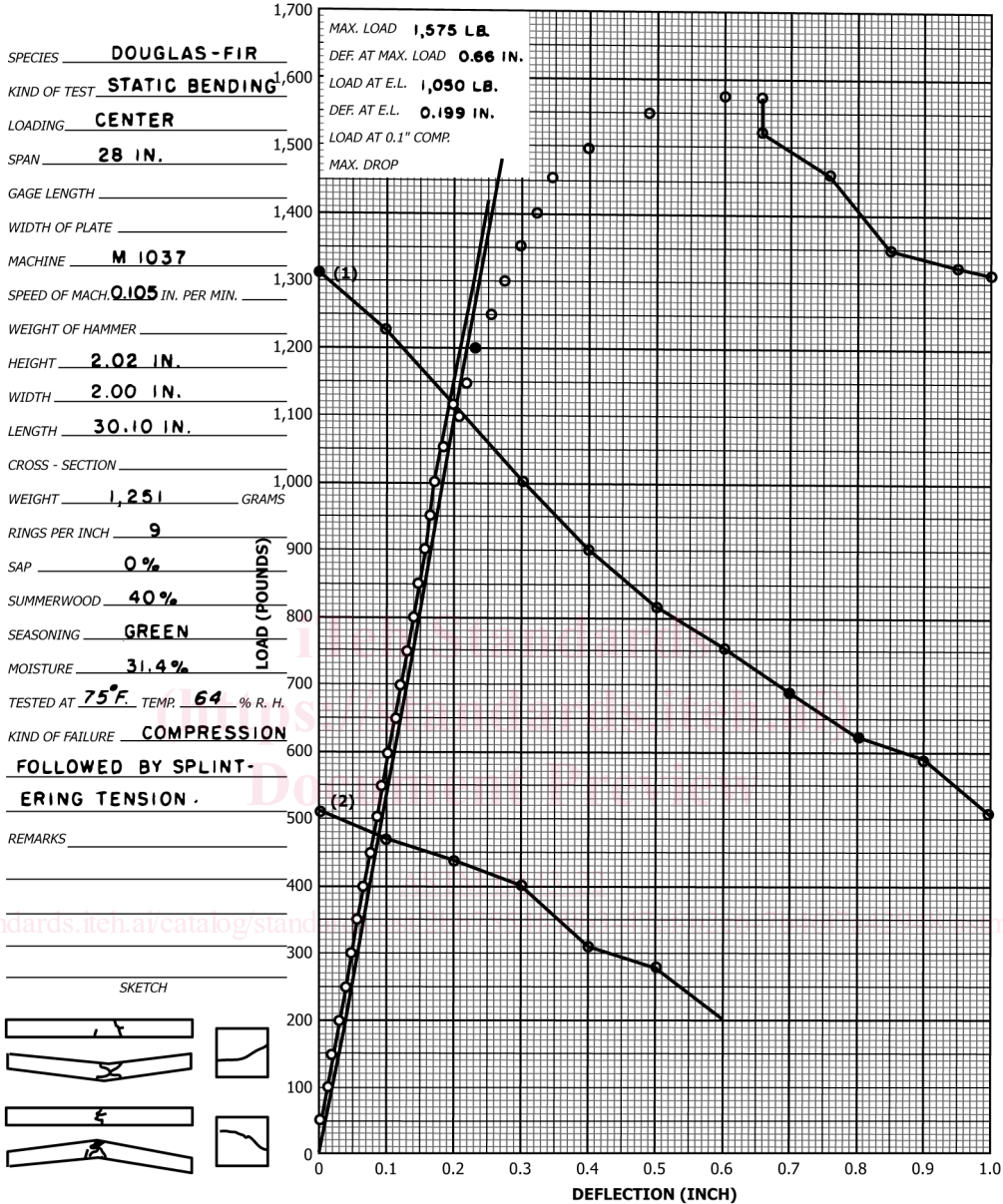

FIG. 5 Sample Data Sheet for a Manually Recorded Static Bending Test

9.4.2 Deformations shall be recorded using displacement measurement devices that are capable of a Class A rating when evaluated in accordance with Practice E2309.

9.4.3 Figs. 8 and 9 illustrate two types of compressometers that have been found satisfactory for wood testing. Similar apparatus is available for measurements of compression over a 2 in. (50 mm) gage gauge length.

9.5 Position of Failures—In order to obtain satisfactory and uniform results, it is necessary that the failures be made to develop in the body of the specimen. With specimens of uniform cross section, this result can best be obtained when the ends are at a very slightly lower moisture content than the body. With green material, it will usually suffice to close-pile the specimens, cover the



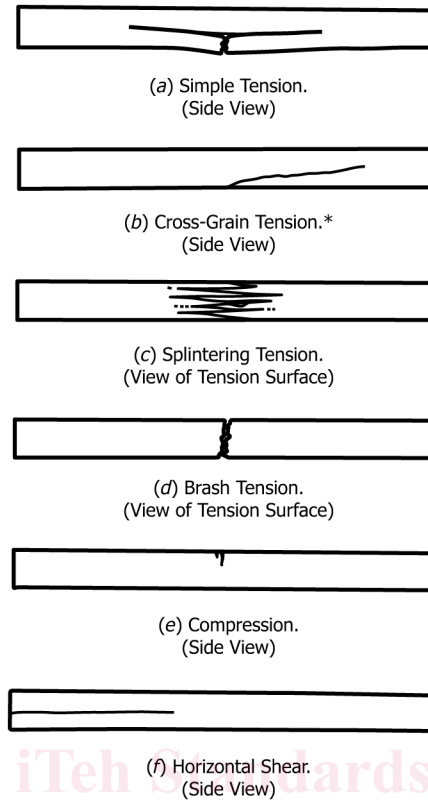

FIG. 6 Types of Failures in Static Bending

NOTE 1—The term “cross grain” shall be considered to include all deviations of grain from the direction of the longitudinal axis or longitudinal edges of the specimen. It should be noted that spiral grain may be present even to a serious extent without being evident from a casual observation.

NOTE 2—The presence of cross grain having a slope that deviates more than 1 in 20 from the longitudinal edges of the specimen shall be cause for culling the test.

body with a damp cloth, and expose the ends for a short time. For dry material, it shall be permitted to pile the specimens in a similar manner and place them in a desiccator, if failures in test indicate that a slight end-drying is necessary.

9.6 *Descriptions of Failure*—Compression failures shall be classified in accordance with the appearance of the fractured surface (Fig. 10). In case two or more kinds of failures develop, all shall be described in the order of their occurrence; for example, shearing followed by brooming. Each type of observed failure mode shall be photographed or sketched.

9.7 *Weight and Moisture Content*—See 8.8.

9.8 *Ring and Latewood Measurement*—When practicable, the number of rings per inch (average ring width in millimeters) and the proportion of summerwood shall be measured over a representative inch (centimeter) of cross section of the test specimen. In determining the proportion of summerwood, it is essential that the end surface be prepared so as to permit accurate latewood measurement. When the fibers are broomed over at the ends from sawing, a light sanding, planing, or similar treatment of the ends is recommended.

**10. Impact Bending**

10.1 *Size of Specimens*—The impact bending tests shall be made on 2 in. by 2 in. by 30 in. (50 mm by 50 mm by 760 mm) specimens. The actual height and width at the center and the length shall be measured (see 22.2).

10.2 *Loading and Span*—Use center loading and a span length of 28 in. (710 mm).

10.3 *Bearing Block*—A metal tup of curvature corresponding to the bearing block shown in Fig. 4 shall be used in applying the load.

FILE NO. 124  
 COST CHARGE \_\_\_\_\_  
 LABORATORY NO. 871,902

U. S. DEPARTMENT OF AGRICULTURE  
 FOREST SERVICE

STATION - MADISON DATE - NOV. 5, 1943 SHIP NO. 1590 STICK NO. S-5  
 PIECE NO. 5 MARK d

MEASURED \_\_\_\_\_  
 TESTED \_\_\_\_\_  
 WEIGHED \_\_\_\_\_

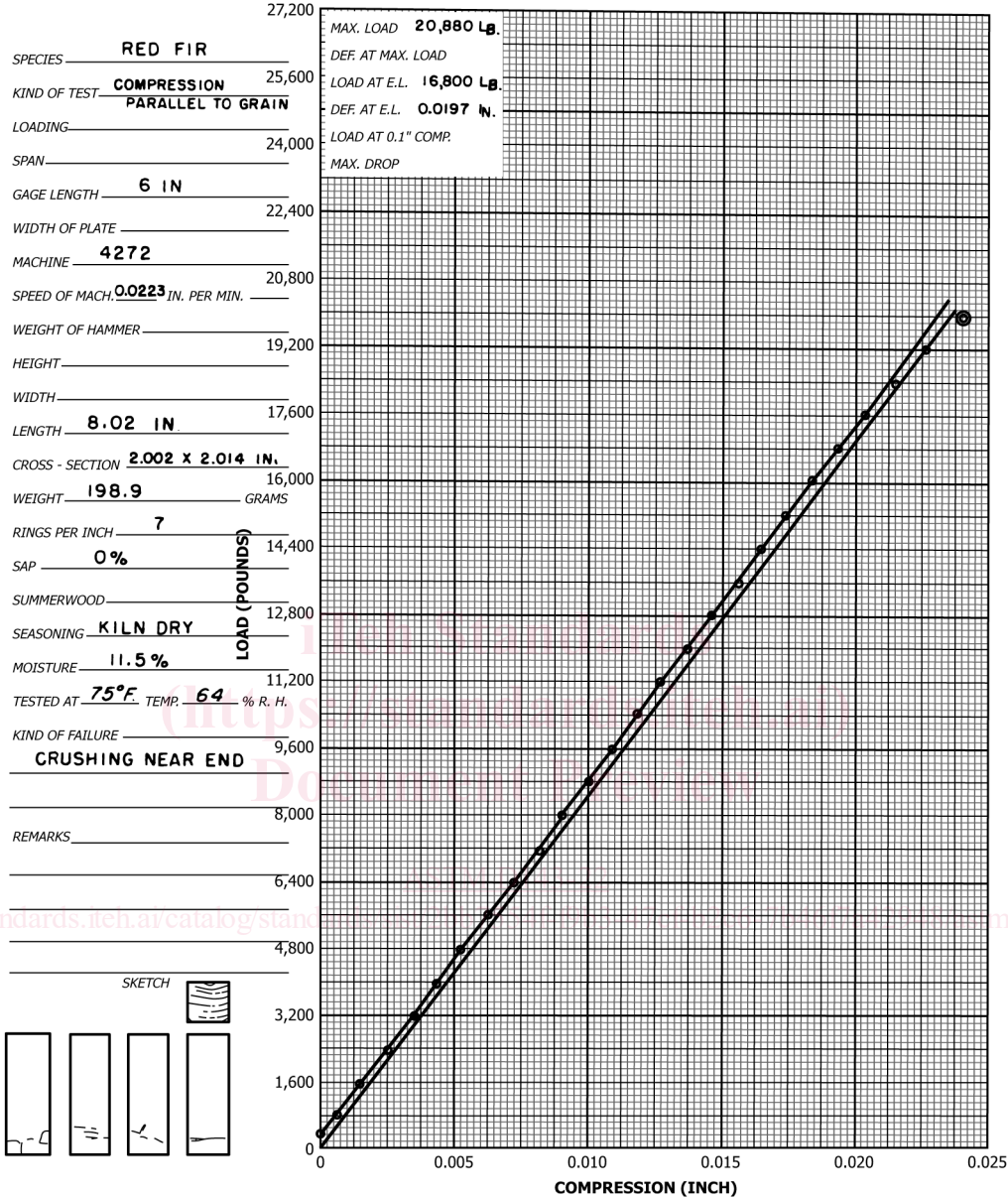

FIG. 7 Sample Data Sheet for a Manually Recorded Compression-Parallel-to-Grain Test

10.4 *Placement of Growth Rings*—The specimen shall be placed so that the load will be applied through the bearing block to the tangential surface nearest the pith.

10.5 *Procedure*—Make the tests by increment drops in a Hatt-Turner or similar impact machine (see Fig. 11). The first drop shall be 1 in. (25 mm), after which increase the drops by 1 in. increments until a height of 10 in. (250 mm) is reached. Then use a 2 in. (50 mm) increment until complete failure occurs or a 6 in. (150 mm) deflection is reached.

10.6 *Weight of Hammer*—A 50 lbm (22.5 kg) hammer shall be used with drops up to the capacity of the machine provided that complete failure or a 6 in. (150 mm) deflection will result for all specimens of a species. For all other cases, a 100 lbm (45 kg) hammer shall be used.

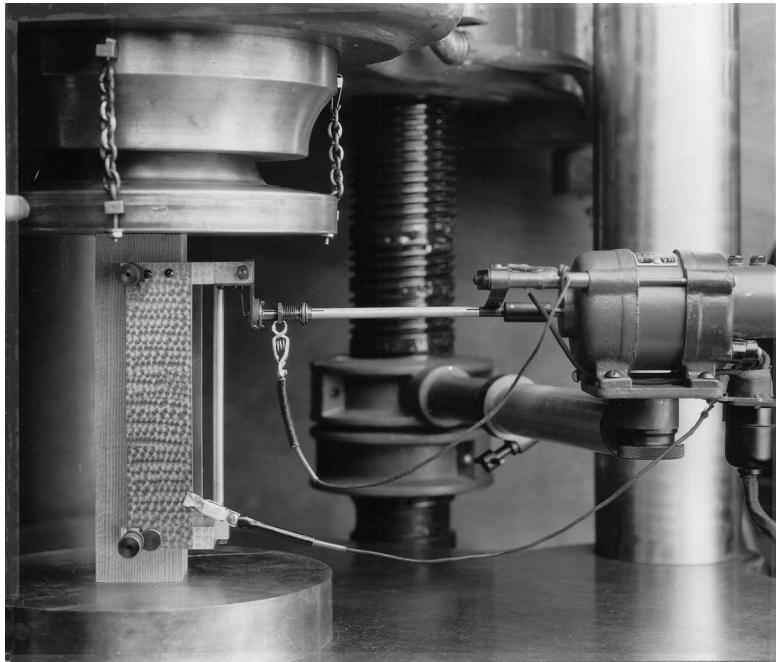

FIG. 8 Compression-Parallel-to-Grain Test Assembly Using an Automatic Type of Compressometer to Measure Deformations (The wire in the lower right-hand corner connects the compressometer with the recording unit.)

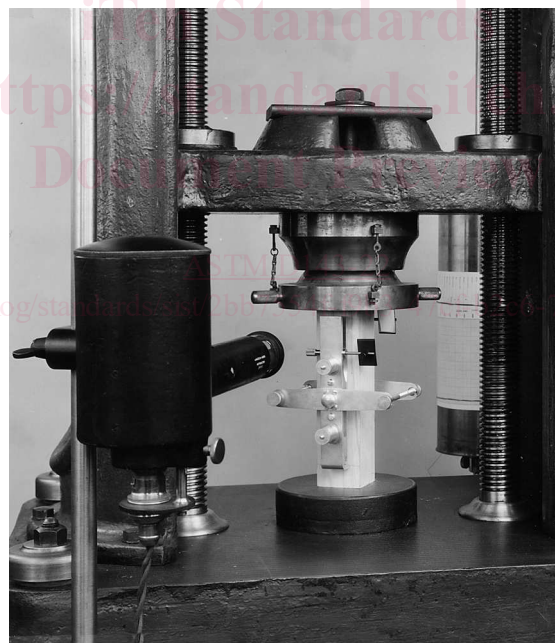

FIG. 9 Compression-Parallel-to-Grain Test Assembly Showing Method of Measuring Deformations by Means of Roller-Type Compressometer

10.7 *Deflection Records*—When desired, records giving the deflection for each drop and the set, if any, shall be made until the first failure occurs. This record will also afford data from which the exact height of drop can be scaled for at least the first four falls.

NOTE 6—See Fig. 12 for a sample drum record.

10.8 *Drop Causing Failure*—The height of drop causing either complete failure or a 6 in. (150 mm) deflection shall be observed for each specimen.

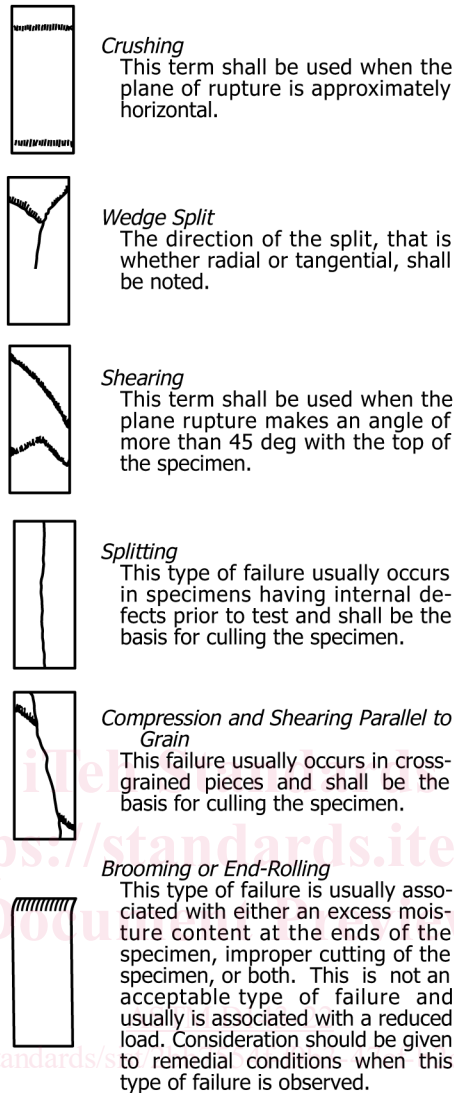

FIG. 10 Types of Failures in Compression

10.9 *Description of Failure*—The failure shall be classified in accordance with the directions for static bending in 8.7. Each type of observed failure mode shall be photographed or sketched.

NOTE 7—See Fig. 13 for a sample of a manually recorded impact bending data sheet form. A sample data and computation card are shown in Fig. 14.

10.10 *Weight and Moisture Content*—See 8.8.

## 11. Toughness

11.1 A single-blow impact test on a small specimen is recognized as a valuable and desirable test. Several types of machines such as the Toughness, Izod and Amsler have been used, but insufficient information is available to decide whether one procedure is superior to another, or whether the results by the different test methods can be directly correlated. If the Toughness machine is used, the following procedure has been found satisfactory. To aid in standardization and to facilitate comparisons, the size of the toughness specimen has been made equal to that accepted internationally.

11.2 *Size of Specimen*—The toughness tests shall be made on 0.79 in. by 0.79 in. by 11 in. (20 mm by 20 mm by 280 mm) specimens. The actual height and width at the center and the length shall be measured (see 22.2).