



Designation: D1210 – 05 (Reapproved 2022)

Standard Test Method for Fineness of Dispersion of Pigment-Vehicle Systems by Hegman-Type Gage¹

This standard is issued under the fixed designation D1210; the number immediately following the designation indicates the year of original adoption or, in the case of revision, the year of last revision. A number in parentheses indicates the year of last reapproval. A superscript epsilon (ϵ) indicates an editorial change since the last revision or reapproval.

This standard has been approved for use by agencies of the U.S. Department of Defense.

1. Scope

1.1 This test method covers measurement of the degree of dispersion (commonly referred to as “fineness of grind”) of the pigment in a pigment-vehicle system such as liquid coatings and their intermediates. It may also be used to assess the inclusion of particulates by a cleanliness (or texture) rating.

1.2 The values stated in SI units are to be regarded as the standard. The values given in parentheses are for information only.

1.3 *This standard does not purport to address all of the safety concerns, if any, associated with its use. It is the responsibility of the user of this standard to establish appropriate safety, health, and environmental practices and determine the applicability of regulatory limitations prior to use.*

1.4 *This international standard was developed in accordance with internationally recognized principles on standardization established in the Decision on Principles for the Development of International Standards, Guides and Recommendations issued by the World Trade Organization Technical Barriers to Trade (TBT) Committee.*

2. Referenced Documents

2.1 *ASTM Standards:*²

D1316 Test Method for Fineness of Grind of Printing Inks By the NPIRI Grindometer

3. Summary of Test Method

3.1 *Tapered Gage*—The product is spread by means of a scraper in a machined tapered path. At some point in this path, particles or agglomerates, or both, will become visible. A direct reading from the graduated scale is then made at the point

¹ This test method is under the jurisdiction of ASTM Committee D01 on Paint and Related Coatings, Materials, and Applications and is the direct responsibility of Subcommittee D01.24 on Physical Properties of Liquid Paints & Paint Materials.

Current edition approved July 1, 2022. Published July 2022. Originally approved in 1952. Last previous edition approved in 2014 as D1210 – 05 (2014). DOI: 10.1520/D1210-05R22.

² For referenced ASTM standards, visit the ASTM website, www.astm.org, or contact ASTM Customer Service at service@astm.org. For *Annual Book of ASTM Standards* volume information, refer to the standard’s Document Summary page on the ASTM website.

where the particles form a definite pattern. When the single path gage is used it is also possible to rate “cleanliness” (see 6.2).

3.2 *Stepped Gage*—The product is spread by means of a scraper on a stepped gage. There are 2 delimited sections on this gage, each of 6.5 cm² (1 in.²) area, and of two different depths. A count is made of the particles deposited in the two delimited areas, and cleanliness (texture) reading is determined.

4. Significance and Use

4.1 In making pigmented products, the pigment is usually dispersed in a portion of the vehicle in some sort of mill. At this stage, it is necessary to be able to judge if the pigment agglomerates have been sufficiently broken up so as not to interfere with the smoothness of the finished coating film. This test method describes a way of making this judgment.

5. Apparatus

5.1 *Tapered Gage*—A hardened steel, stainless steel, or chrome-plated steel block (Fig. 1) approximately 170 mm (6.7 in.) in length, and 15 mm (0.6 in.) in thickness. The top surface of the block shall be ground smooth and planar and shall contain one or two paths 127 mm (5 in.) in calibrated length. The path shall be tapered uniformly in depth lengthwise from about 4 mils (100 μ m) at 10 mm from one end to zero depth at the other with intermediate calibrations in accordance with the depth at those points. Preferred calibrations are Hegman units and micrometers (Note 1). Three path widths are covered by this test method:

5.1.1 *Two Parallel Paths*, each 12.5-mm (0.5-in.) wide and spaced 0.5-in. apart centered in a block 65-mm (2.5-in.) wide (see Fig. 1).

5.1.2 *One Path*, 50 mm (2 in.) in width centered in a block 90-mm (3.5-in.) wide (see Fig. 1).

5.1.3 *One Path*, 25 mm (1 in.) in width centered in a block 65-mm (2.5-in.) wide (see Fig. 1a).

NOTE 1—Several arbitrary scales and modifications of the gage are used by industry. In order that readings obtained with these arbitrary scales and modifications can be reported in the preferred units, the approximate

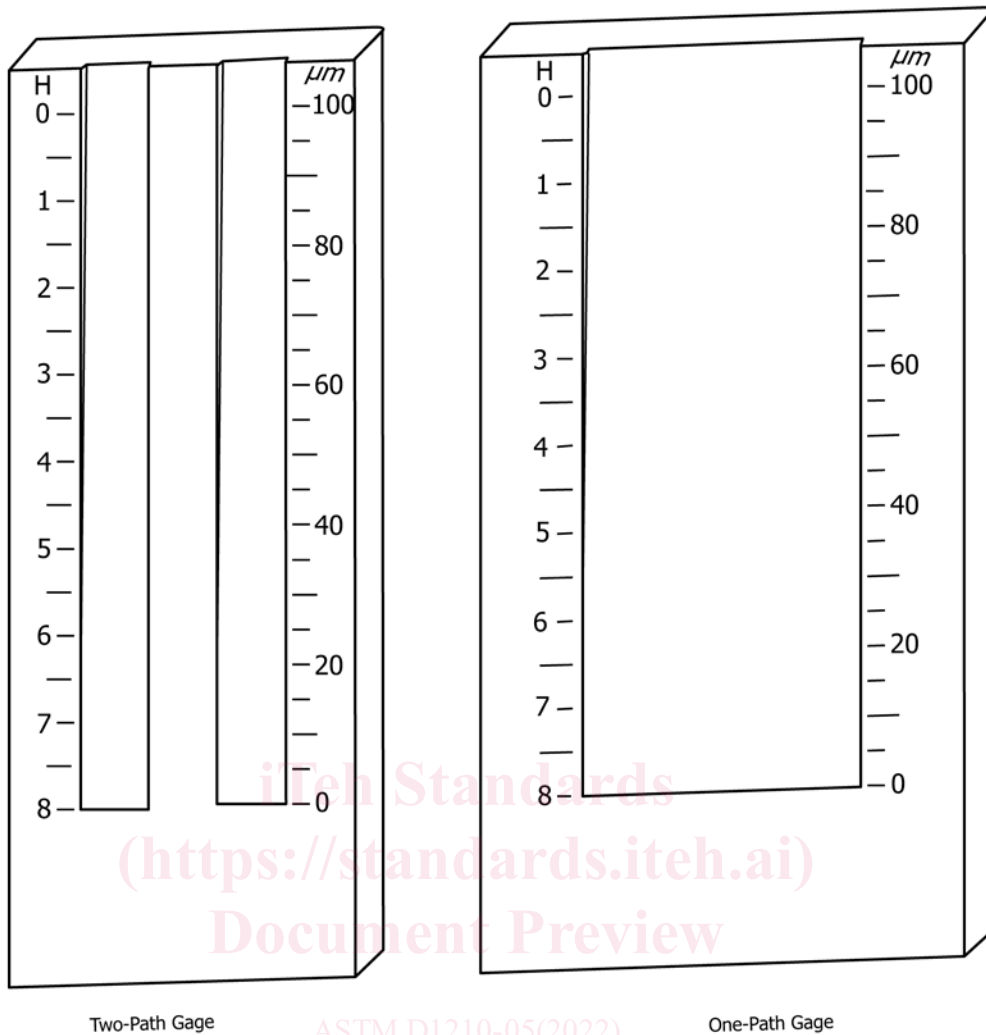

ASTM D1210-05(2022)

FIG. 1 Fineness Gages

<https://standards.iteh.ai/catalog/standards/sist/8e9ac108-0557-4667-85b2-200e03c84b19/astm-d1210-052022>

relationship of these scales to gage depth is shown in the following example:

| Hegman Scale ^A | Depth, μm ^B | Depth, mils ^B | PC or FSPT Scale ^C | NPIRI Scale ^D |
|---------------------------|------------------------|--------------------------|-------------------------------|--------------------------|
| 0 | 100 | 4 | 0 | 40 |
| 1 | 90 | 3.5 | 1¼ | 35 |
| 2 | 75 | 3 | 2½ | 30 |
| 3 | 65 | 2.5 | 3¾ | 25 |
| 4 | 50 | 2 | 5 | 20 |
| 5 | 40 | 1.5 | 6¼ | 15 |
| 6 | 25 | 1 | 7½ | 10 |
| 7 | 15 | 0.5 | 8¾ | 5 |
| 8 | 0 | 0 | 10 | 0 |

^A Sometimes referred to in error as the North Standard scale.
^B Rounded to nearest 5 μm or 0.5 mil.
^C Federation of Societies for Paint Technology scale.
^D National Printing Ink Research Institute scale, 0 to 10 on the NPIRI Production Grindometer, but extended on many gages to 20 or 30 (see Test Method D1316).

5.2 *Stepped Gage*—A hardened steel, stainless steel, or chrome-plated steel block (Fig. 1a), approximately 170 mm (6.7 in.) in length, and 15 mm (0.6 in.) in thickness. A path

25-mm (1-in.) wide shall be cut the length of, and centered in a block 65-mm (2.5-in.) wide. The path will be cut to two different depths, each for half of its length. The two depths will be 3 mils, and 1 mil, or as agreed upon between the buyer and the seller. There shall be two tick marks, above and below the “step,” and spaced 25 mm (1 in.) from it.

5.3 *Scraper*—A double-edged hardened steel, stainless steel, or chrome-plated steel blade (Fig. 2) 95-mm (3.75-in.) long, 40-mm (1.5-in.) wide, and 6.4-mm (0.25-in.) thick. The two edges on the 3.75-in. sides shall be rounded to a radius of 0.38 mm (0.015 in.).

5.4 *Illumination*—The gage shall be illuminated for viewing with a fluorescent tube, mounted approximately 250 mm (10 in.) above the gage with the length of the tube parallel to the length of the gage. The tube will be mounted so that the angle between the plane of the gage, and the tube is 75 to 80°. A

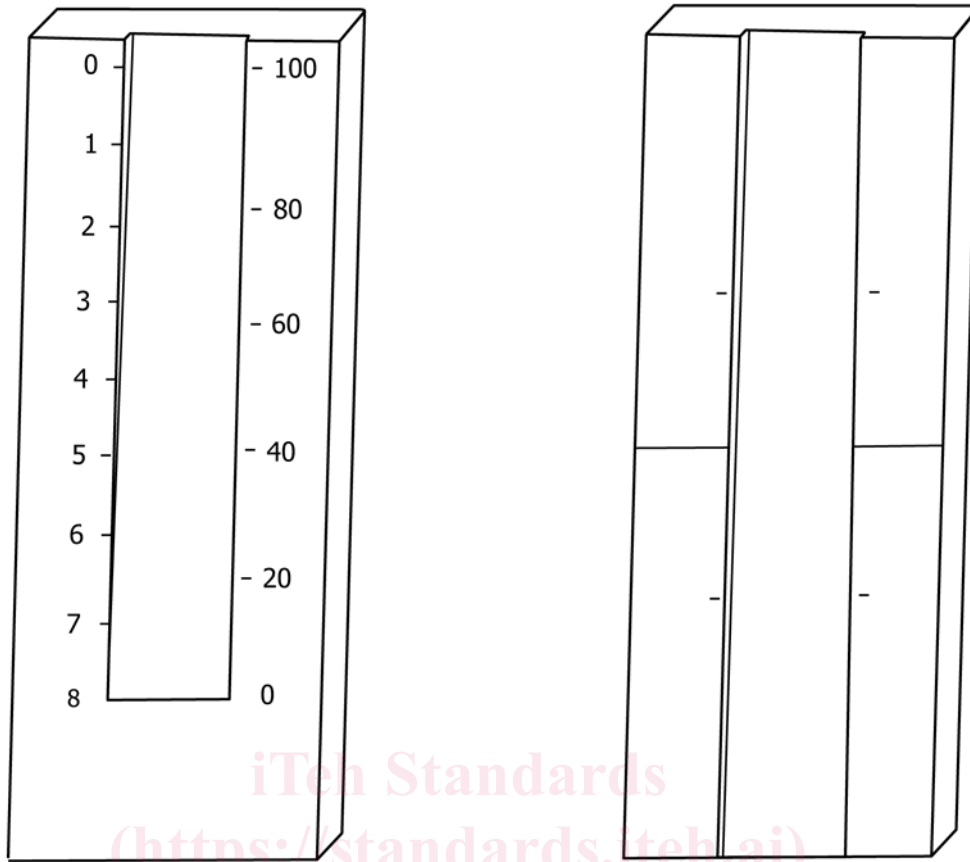

1-in. single path gage

Texture Gage

FIG. 1 a Fineness Gages (continued)

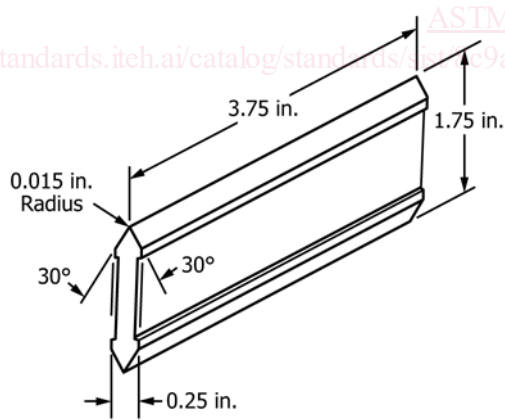

NOTE 1—1 in. = 25.4 mm.

FIG. 2 Scraper

all times when not in use. Protect gages that lie idle for extended periods of time from rust with an oil coating or oil soaked wrap.

6.2 Do not allow any hard materials to come in contact with the gage surface or scraper in any manner that might result in scarring or nicking. Avoid tapping or scratching with other metal.

6.3 The scraper may be rendered unsatisfactory for use by wear or nicks of the contact edge or warpage (Note 2). Replace or recondition unsatisfactory blades.

NOTE 2—Wear or warpage of the scraper may be noted by facing the edge of the scraper down on the smooth level face of the gage, then inspecting the contact edge by means of a strong light, placed behind the gage. Rocking the scraper forward or back will reveal poor contact due to wear or warpage. Any light coming through between scraper and gage face shows that the scraper has been damaged and is not satisfactory for use.

7. Visual Standards

7.1 The diagrams in Fig. 3 are reproductions of six typical fineness-gage patterns with the double-path gage in 5.1.1, and they should be viewed with the purpose of standardizing the relationship of particle distribution to fineness designation. The arrow in each drawing represents the end point (reading) for that distribution. These patterns are to be used for notation of

viewing box is not mandatory for illumination, but if one is desired, a proposed design for a viewing box is contained in Appendix X1.

6. Care of Gage

6.1 Clean the gage immediately after each use. Use a solvent and a soft cloth. Keep the gage covered or encased at

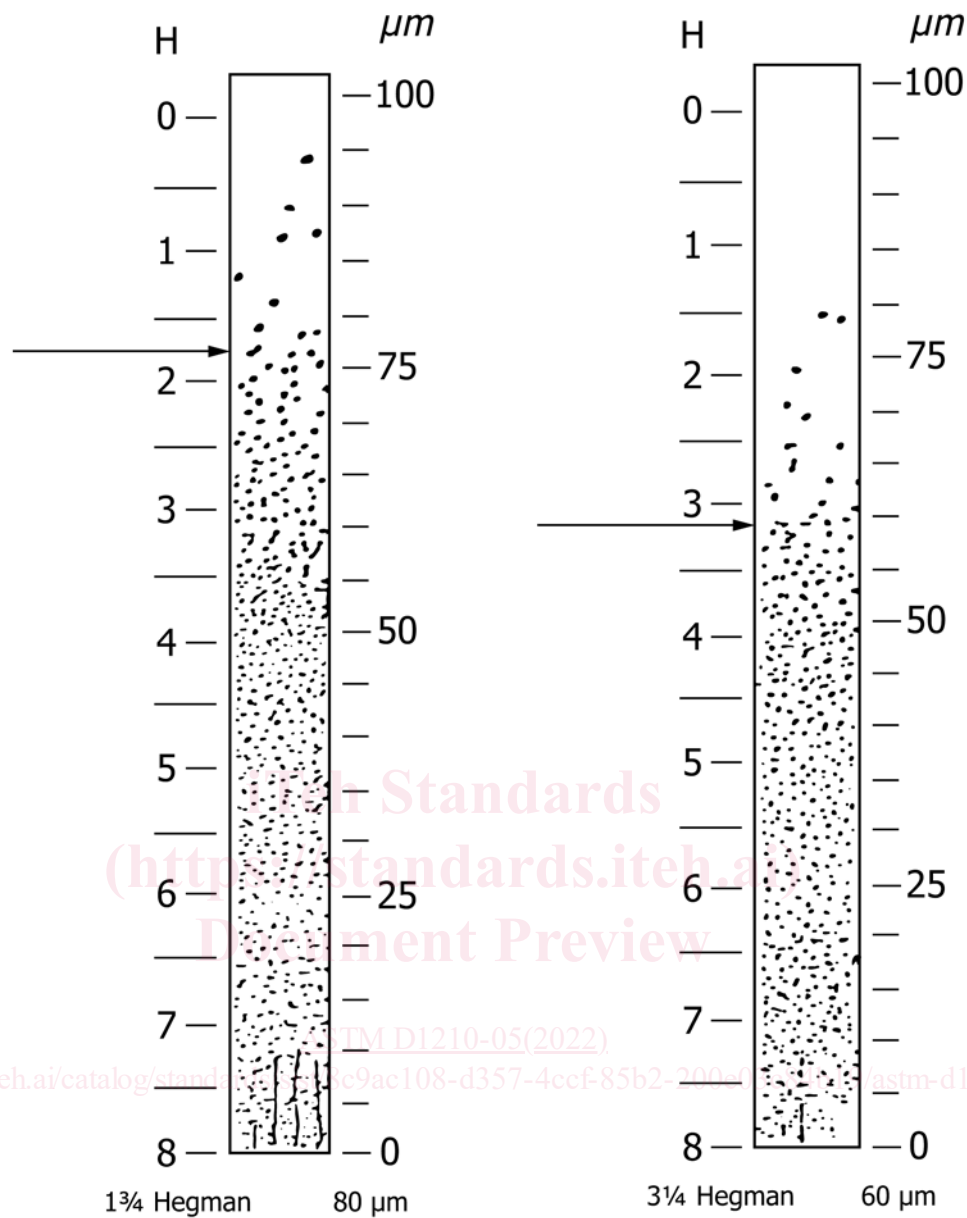

FIG. 3 a Typical Fineness Gage Patterns

frequency of particles and should not be interpreted according to the size of the dots. Although called “standards,” they are really examples of fineness readings to be used as a guide, since no two particle distributions will be exactly the same.

7.2 Similarly, Fig. 4 exhibits typical fineness gage patterns for the 50-mm (2-in.) gage in 5.1.2, or the 25-mm (1-in.) gage in 5.1.3. These diagrams are to be used like those for the double-path gage except that a “cleanliness” rating is also shown. “Cleanliness” is descriptive of the number of particles that appear in the path above the fineness designation. Three ratings are indicated: A (0 to 8 specks), B (9 to 15 specks), and C (16 or more specks).

8. Procedure—Tapered Gage

8.1 Place the gage on a horizontal flat, nonslippery surface and wipe clean immediately before the test. Be sure the gage surface is free of lint.

8.2 Hand stir the specimen (Note 3) vigorously for 2 min, taking care that air bubbles are not whipped into the paint. To be sure of an accurate grind reading, specimens must be free of air bubbles.

NOTE 3—For this test method to function properly, the pigment particles in the specimens to be tested should be free to settle to the bottom of the gage channel after the drawdown. Therefore, before testing, high-viscosity intermediate specimens that have little ability to flow should be reduced with a compatible liquid. Reduction should be in approximately the same proportion as the intermediate will be reduced in practice.

8.3 Immediately place the material to be tested in the deep end of the path, or paths, so that it overflows the path slightly. When using the double-path gage, place material in both paths.

8.4 Holding the scraper in both hands, nearly vertical but inclined slightly toward the operator, draw the material down the length of the path toward the shallow end of the gage with a uniform, brisk motion in approximately 1 to 3 s. Exert upon

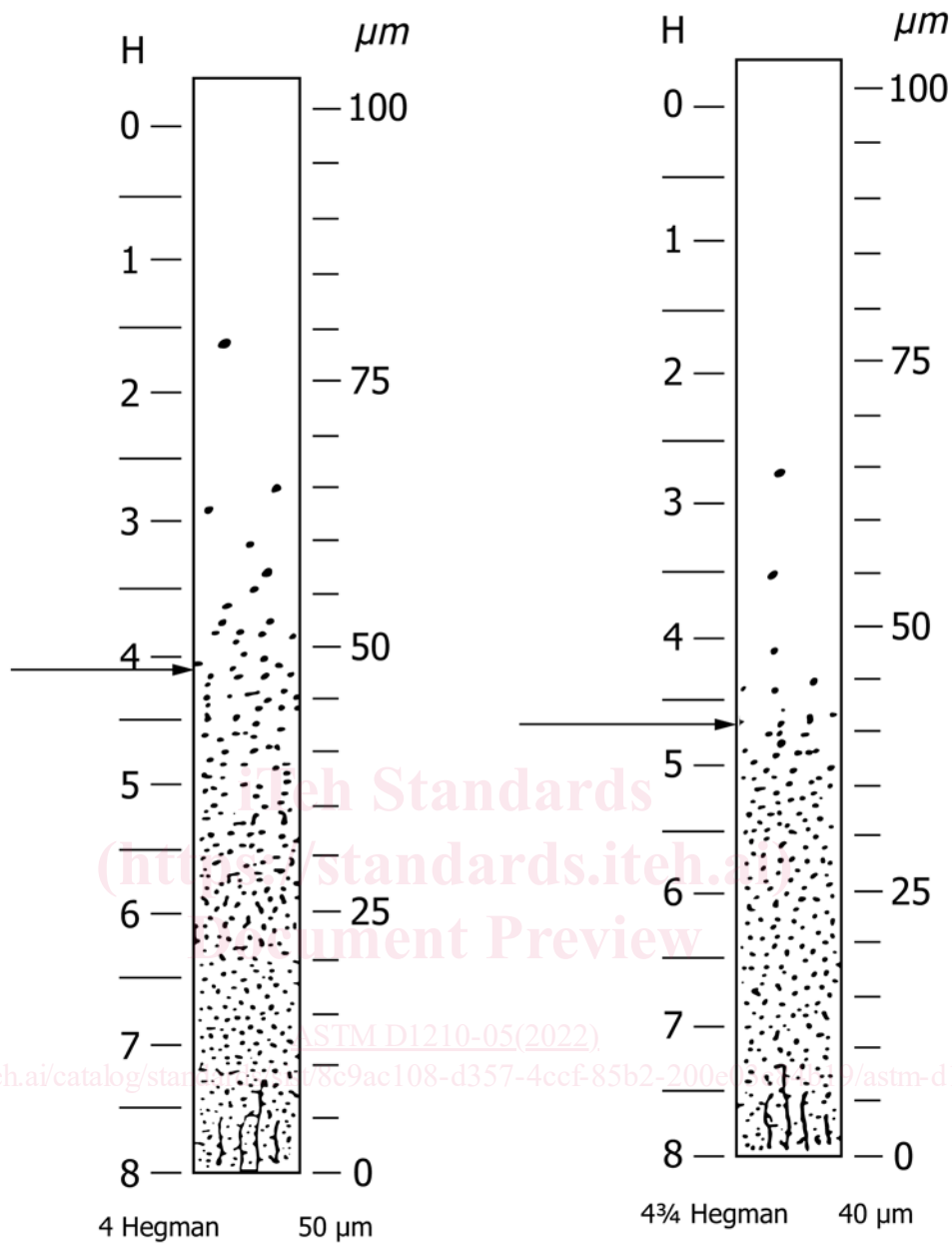

FIG. 3 b Typical Fineness Gage Patterns (continued)

the scraper only sufficient pressure to clean excess material from the face of the gage. Within 10 s of placing the specimen on the gage, make a reading as follows:

8.4.1 View the gage from the side, perpendicular to the length of the path. Keeping the gage between the operator and the light source, make the angle between the face of the gage and the line of vision so that the image of the fluorescent tube appears in the material on the gage.

NOTE 4—Clear finishes may have to be viewed at a lower angle or they may have to be opacified with a finely ground colorant or dye in order to see the particles better.

8.4.2 It is important to decide in which direction to scan the gage (from the deep end (0 Hegman or 100 μm) toward the shallow end (8 Hegman or 0 μm) or from the shallow end to the deep end.) It is preferable to scan from the shallow end toward

the deep end, since this allows the operator to just decide when the dense pattern breaks, rather than trying to decide whether the pattern has less dense areas within it. (See Fig. 4c). When using the two-path gage, average the values in the two paths to the nearest $\frac{1}{4}$ Hegman unit. This average is considered one reading. The two protocols for reading the fineness are:

8.4.2.1 *Shallow End toward Deep End*—Start at the shallow end of the gage and observe where the first break in the dense pattern of particles occurs. This is the fineness reading.

8.4.2.2 *Deep End toward Shallow End*—Observe the point where the material first shows a definite speckled pattern, not just isolated specks (see Fig. 3 and Fig. 4). This is the fineness reading.

8.5 After the first drawdown and reading, which are preliminary for establishing proper test conditions and locating the

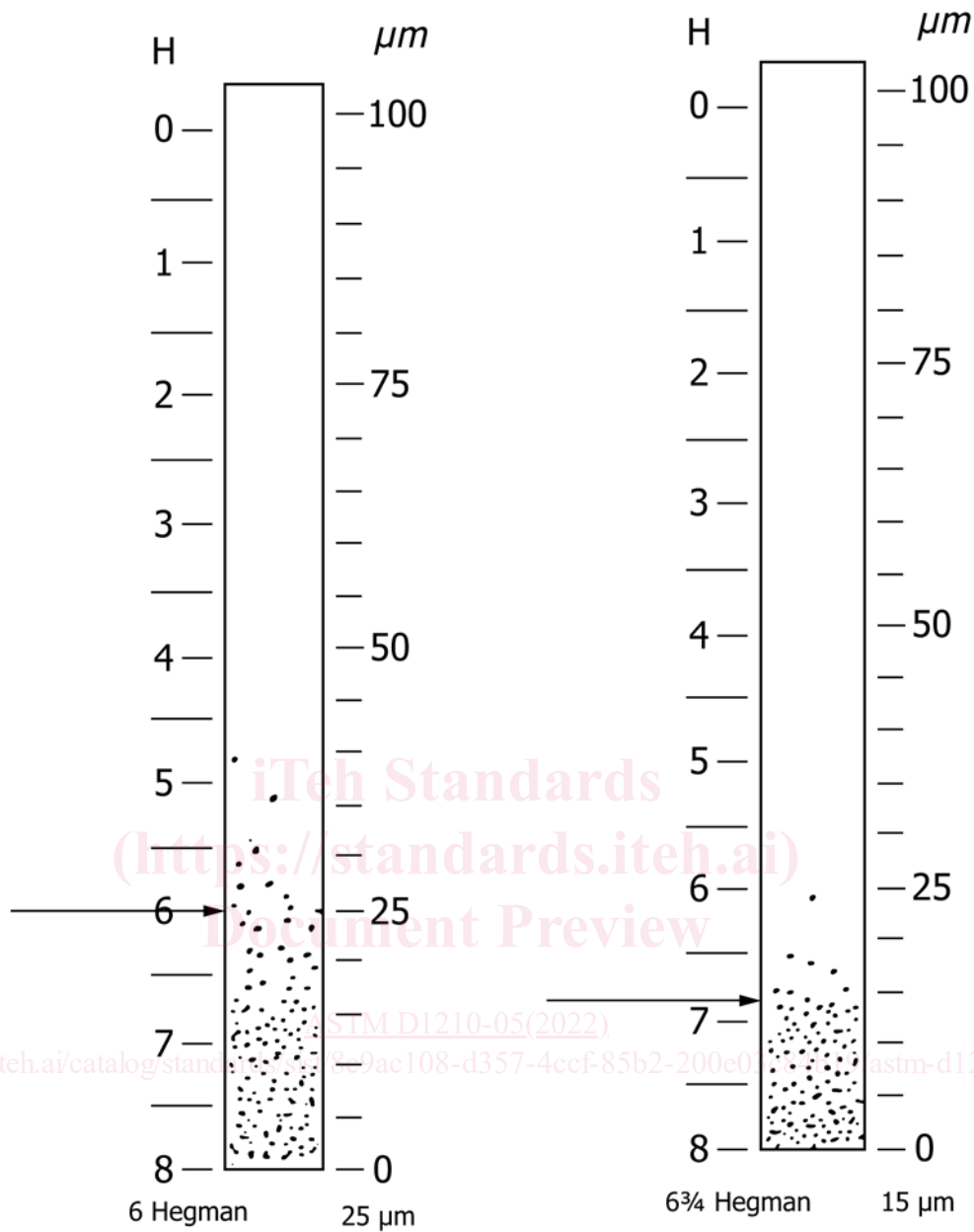

FIG. 3 c Typical Fineness Gage Patterns (continued)

position of the fineness reading, repeat the procedure twice, beginning with 8.3, to obtain two test readings. This process allows the two test readings to be made with limited time lapses between completion of drawdown and reading. (Do not consider any reading for the reported fineness when the time lapse exceeds 10 s.) Average the two readings to the nearest 1/4 Hegman units (5 μm).

8.6 Interpretation of Dispersion Pattern:

8.6.1 Inspect the initial drawdown for pattern and the approximate fineness. Determine the point in the particle distribution that approximates a similar end point pattern to that of the pictorial standards.

8.6.2 Judge cleanliness on the one-path gage either by comparison to the typical fineness patterns (shown only at a

Hegman level but applicable by analogy to any fineness level) or by counting nibs coarser than the selected fineness level (see 7.2 for cleanliness ranges).

9. Procedure—Stepped Gage

9.1 Place the gage on a horizontal flat, nonslippery surface and wipe clean immediately before the test. Be sure the gage surface is free of lint.

9.2 Hand stir the specimen (Note 3) vigorously for 2 min, taking care that air bubbles are not whipped into the paint. To be sure of an accurate grind reading, specimens must be free of air bubbles.

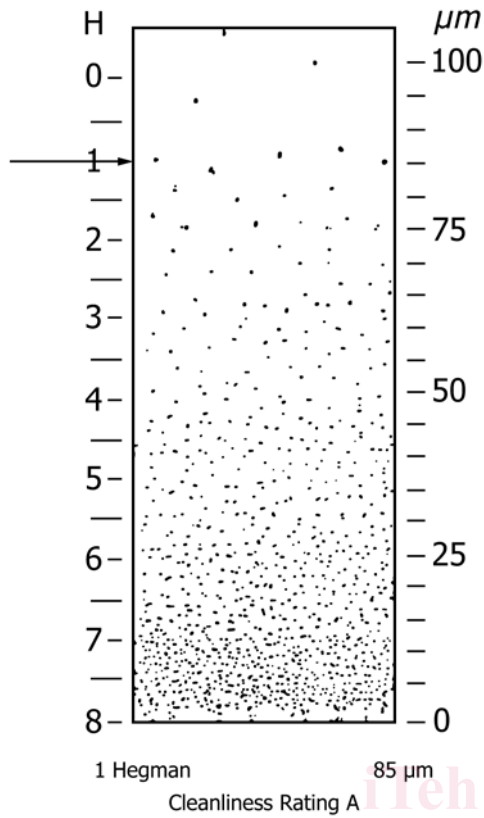

FIG. 4 a Typical Fineness Gage Pattern

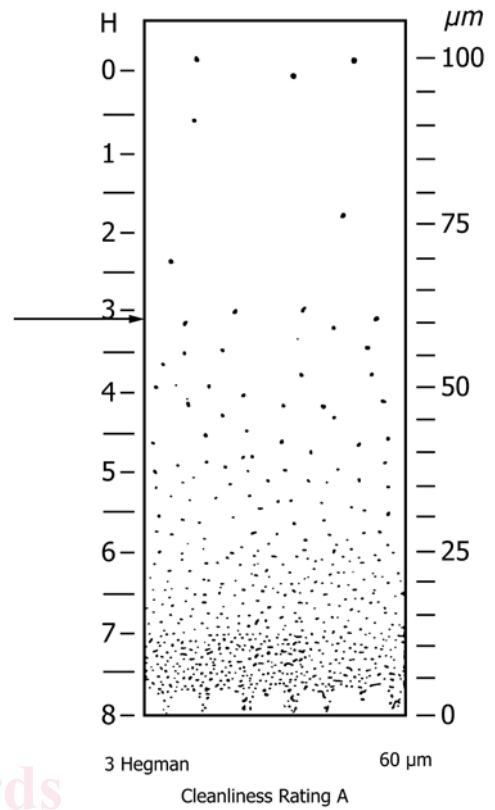

FIG. 4 c Typical Fineness Gage Pattern (continued)

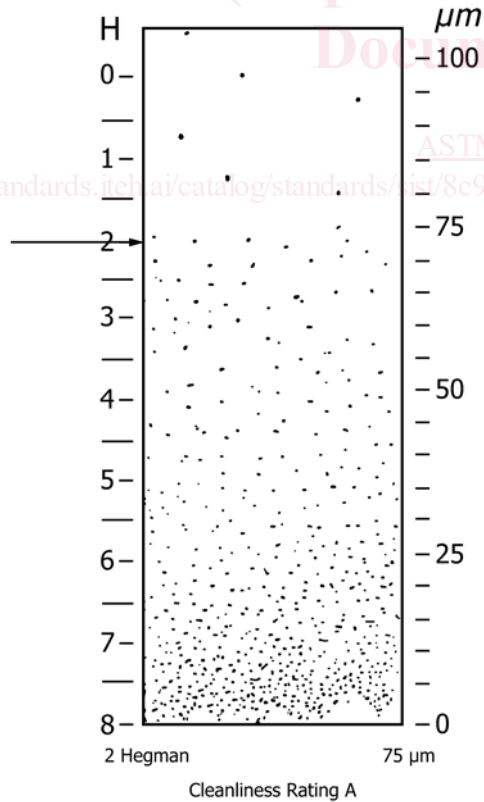

FIG. 4 b Typical Fineness Gage Pattern (continued)

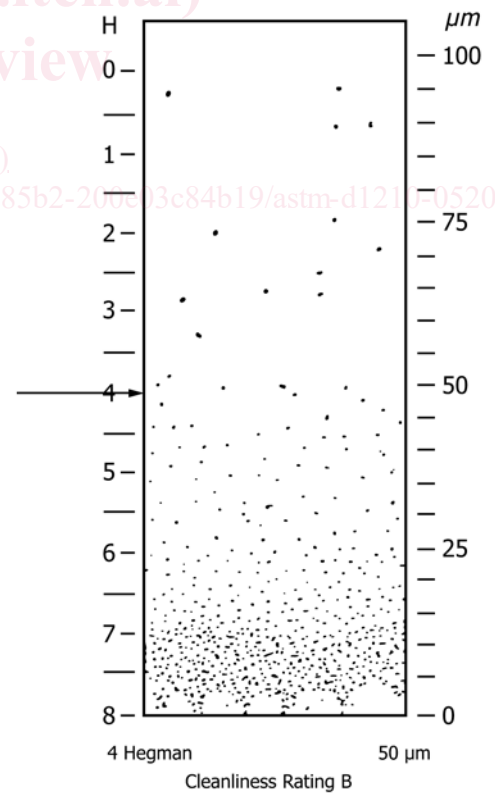

FIG. 4 d Typical Fineness Gage Pattern (continued)

NOTE 5—For this test method to function properly, the pigment particles

in the specimens to be tested should be free to settle to the bottom of the gage channel after the drawdown. Therefore, before testing, high-viscosity