



Designation: E520 – 08 (Reapproved 2023)

Standard Practice for Describing Photomultiplier Detectors in Emission and Absorption Spectrometry¹

This standard is issued under the fixed designation E520; the number immediately following the designation indicates the year of original adoption or, in the case of revision, the year of last revision. A number in parentheses indicates the year of last reapproval. A superscript epsilon (ϵ) indicates an editorial change since the last revision or reapproval.

1. Scope

1.1 This practice covers photomultiplier properties that are essential to their judicious selection and use in emission and absorption spectrometry. Descriptions of these properties can be found in the following sections:

	Section
Structural Features	4
General	4.1
External Structure	4.2
Internal Structure	4.3
Electrical Properties	5
General	5.1
Optical-Electronic Characteristics of the Photocathode	5.2
Current Amplification	5.3
Signal Nature	5.4
Dark Current	5.5
Noise Nature	5.6
Photomultiplier as a Component in an Electrical Circuit	5.7
Precautions and Problems	6
General	6.1
Fatigue and Hysteresis Effects	6.2
Illumination of Photocathode	6.3
Gas Leakage	6.4
Recommendations on Important Selection Criteria	7

1.2 Radiation in the frequency range common to analytical emission and absorption spectrometry is detected by photomultipliers presently to the exclusion of most other transducers. Detection limits, analytical sensitivity, and accuracy depend on the characteristics of these current-amplifying detectors as well as other factors in the system.

1.3 *This standard does not purport to address all of the safety concerns, if any, associated with its use. It is the responsibility of the user of this standard to establish appropriate safety, health, and environmental practices and determine the applicability of regulatory limitations prior to use.*

1.4 *This international standard was developed in accordance with internationally recognized principles on standardization established in the Decision on Principles for the Development of International Standards, Guides and Recom-*

mendations issued by the World Trade Organization Technical Barriers to Trade (TBT) Committee.

2. Referenced Documents

- 2.1 *ASTM Standards:*²
[E135 Terminology Relating to Analytical Chemistry for Metals, Ores, and Related Materials](#)

3. Terminology

3.1 *Definitions*—For terminology relating to detectors refer to Terminology [E135](#).

3.2 *Definitions of Terms Specific to This Standard:*

3.2.1 *solar blind, n*—photocathode of photomultiplier tube does not respond to higher wavelengths.

3.2.1.1 *Discussion*—In general, solar blind photomultiplier tubes used in atomic emission spectrometry transmit radiation below about 300 nm and do not transmit wavelengths above 300 nm.

4. Structural Features

4.1 *General*—The external structure and dimensions, as well as the internal structure and electrical properties, can be significant in the selection of a photomultiplier.

4.2 *External Structure*—The external structure consists of envelope configurations, window materials, electrical contacts through the glass-wall envelopes, and exterior housing.

4.2.1 *Envelope Configurations*—Glass envelope shapes and dimensions are available in an abundant variety. Two envelope configurations are common, the end-on (or head-on) and side-on types (see [Fig. 1](#)).

4.2.2 *Window Materials*—Various window materials, such as glass, quartz and quartz-like materials, sapphire, magnesium fluoride, and cleaved lithium fluoride, cover the ranges of spectral transmission essential to efficient detection in spectroscopic applications. Window cross sections for the end-on type photomultipliers include plano-plano, plano-concave,

¹ This practice is under the jurisdiction of ASTM Committee E01 on Analytical Chemistry for Metals, Ores, and Related Materials and is the direct responsibility of Subcommittee E01.20 on Fundamental Practices.

Current edition approved April 1, 2023. Published April 2023. Originally approved in 1998. Last previous edition approved in 2015 as E520 – 08 (2015)^{ε1}. DOI: 10.1520/E0520-08R23.

² For referenced ASTM standards, visit the ASTM website, www.astm.org, or contact ASTM Customer Service at service@astm.org. For *Annual Book of ASTM Standards* volume information, refer to the standard's Document Summary page on the ASTM website.

A

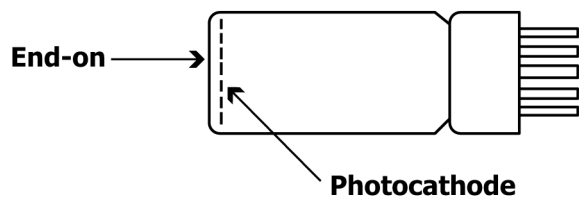

B

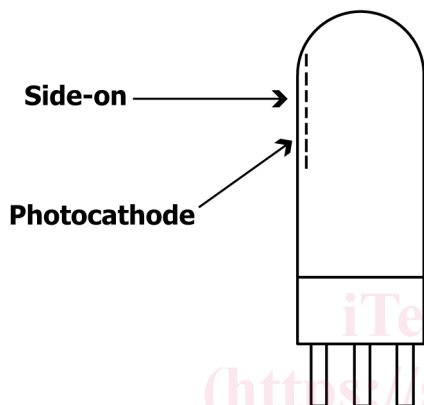

FIG. 1 Envelope Configurations

convexo-concave forms, and a hemispherical form for the collection of $2\text{-}\pi$ radians of light flux.

4.2.3 *Electrical Connections*—Standard pin bases, flying-leads, or potted pin bases are available to facilitate the location of a photomultiplier, or for the use of a photomultiplier at low temperatures. TFE-fluorocarbon receptacles for pin-base types are recommended to minimize the current leakage between pins.

4.2.4 *Housing*—The housing for a photomultiplier should be “light tight.” Light leaks into a housing or monochromator from fluorescent lamps are particularly bad noise sources which can be readily detected with an oscilloscope adjusted for twice the power line frequency. A mu-metal housing or shield is recommended to diminish stray magnetic field interferences with the internal focus on electron trajectories between tube elements.

4.3 *Internal Structure*—The internal structure consists of arrangements of cathode, dynodes, and anodes.

4.3.1 *Photocathode*—A typical photomultiplier of the end-on configuration possesses a semitransparent to opaque layer of photoemissive material that is deposited on the inner surface of the window segment in an evacuated glass envelope. In the side-on window types, the cathode layer is on a reflective substrate within the evacuated tube or on the inner surface of the window.

4.3.2 *Dynodes and Anode*—Secondary-electron multiplication systems are designed so that the electrons strike a dynode

at a region where the electric field is directed away from the surface and toward the next dynode. Six of these configurations are shown in Fig. 2. Ordinarily a photomultiplier uses from 4 dynodes to 16 dynodes. There are several different configurations of anodes including multianodes and cross wire anodes for position sensitivity.

4.3.3 *Rigidity of Structural Components*—The standard structural components generally will not endure exceptional mechanical shocks. However, specifically constructed photomultipliers (ruggedized) that are resistant to damage by mechanical shock and stress are available for special applications, such as geophysical uses or in mobile laboratories.

5. Electrical Properties

5.1 *General*—The electrical properties of a photomultiplier are a complex function of the cathode, dynodes, and the voltage divider bridge used for gain control.

5.2 *Optical-Electronic Characteristics of the Photocathode*—Electrons are ejected into a vacuum from the conduction bands of semiconducting or conducting materials if the surface of the material is exposed to electromagnetic radiation having a photon energy higher than that required by the photoelectric work-function threshold. The number of electrons emitted per incident photon, that is, the quantum efficiency, is likely to be less than unity and typically less than 0.3.

A Focused



B Venetian Blind

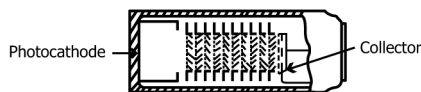

C Box-Grid

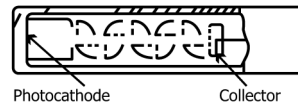

D Circular Cage

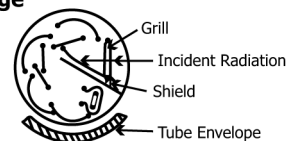

E Fine Mesh

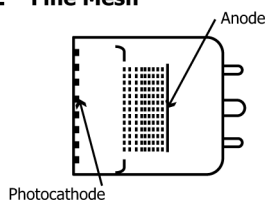

F Microchannel Plate

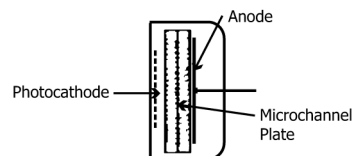

FIG. 2 Electrostatic Dynode Structures

5.2.1 *Spectral Response*—The spectral response of a photocathode is the relative rate of photoelectron production as a function of the wavelength of the incident radiation of constant flux density and solid angle. Spectral response is measured at the cathode with a simple anode or at the anode of a secondary-electron photomultiplier. Usually, this wavelength-dependent response is expressed in amperes per watt at anode.

5.2.1.1 Spectral response curves for several common standard cathode-types are shown in Fig. 3. The S-number is a standard industrial reference number for a given cathode type and spectral response. Some of the common cathode surface compositions are listed below. Semiconductive photocathodes, for example, GaAs(Cs) and InGaAs(Cs), as well as red-enhanced multialkali photocathodes (S-25) are also available. A “solar blind” response cathode of CsI, not shown in Fig. 3, provides a low-noise signal in the 160 nm to 300 nm region of the spectrum. Intensity measurements at wavelengths below 100 nm can be made with a windowless, gold-cathode photomultiplier.

Response Type Designation	Examples of Cathode Surfaces Window	Cathode Surface
S-1?	Lime Glass	Ag-O-Cs (Reflection)
S-5?	Ultraviolet Transmitting Glass	Sb-Cs (Reflection)
S-11	Lime Glass	Sb-Cs (Semitransparent)
S-13	Fused Silica	Sb-Cs (Semitransparent)
S-20	Lime Glass	Sb-Na-K-Cs (Semitransparent)

5.3 *Current Amplification*—The feeble photoelectron current generated at the cathode is increased to a conveniently measurable level by a secondary electron multiplication system. The mechanism for electron multiplication simply depends on the principle that the collision of an energetic electron with a low work-function surface (dynode) will cause the ejection of several secondary electrons. Thus, a primary photoelectron that is directed by an electrostatic field and through an accelerating voltage to the first tube dynode will effectively be amplified by a factor equal to the number of secondary electrons ejected from the single collision.

5.3.1 *Gain per Stage*—The amplification factor or gain produced at a dynode stage depends both on the primary

electron energy and the work function of the material used for the dynode surface. Most often dynode surfaces are Cs-Sb or Be-O composites on Cu/Be or Ni substrates. The gain per dynode stage generally is purposely limited.

5.3.2 *Overall Gain*—A series of dynodes, arranged so that a stepwise amplification of electrons from a photocathode occurs, constitutes a total secondary electron multiplication system. Ordinarily, the number of dynodes employed in a photomultiplier ranges from 4 to 16. The overall gain for a system, G , is related to the mean gain per stage, g , and the number of dynode stages, n , by the equation $G = g^n$. Overall gains in the order of 10^6 can be achieved easily.

5.3.3 *Gain Control (Voltage-Divider Bridge)*—Since, for a given photomultiplier the cathode and dynode surface materials and arrangement are fixed, the only practical means to change the overall gain is to control the voltages applied to the individual tube elements. This control is accomplished by adjusting the voltage that is furnished by a high-voltage supply and that is imposed across a voltage-divider bridge (see Fig. 4). Selection of proper resistance values and the configuration for the voltage-divider bridge ultimately determine whether a given photomultiplier will function with stability and linearity in a certain application. Operational stability is determined by the stability of the high voltage supplied to the divider-bridge by the relative anode and divider-bridge currents and by the stability of each dynode voltage as determined by the divider-bridge.

5.3.3.1 To a first approximation, the error in the gain varies proportionately to the error in the applied high voltage multiplied by the number of stages. Therefore, for a ten-stage tube, a gain stability of $\pm 1\%$ is attained with a power-supply voltage stability of $\pm 0.1\%$.

5.3.3.2 For a tube stability of 1% , the current drawn from the heaviest loaded stage must be less than 1% of the total current through the voltage divider bridge. For most spectroscopic applications, a bridge current of about 0.5 mA to 1 mA is sufficient.

5.3.3.3 The value of R_1 (see Fig. 4) is set to give a voltage between the cathode and the first dynode as recommended by the manufacturer. Resistors $R_2, R_3 \dots R_{n-2}, R_{n-1}, R_n$, and R_{n+1} may be graded to give interstage voltages which are appropriate to the required peak current. With higher interstage voltages at the output end of the tube, higher peak currents can be drawn, but average currents above 1 mA are not normally recommended. The value selected for decoupling capacitors,

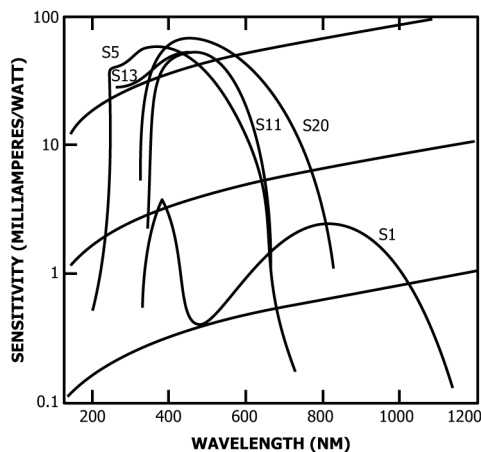

FIG. 3 Spectral Response Curves for Several Cathode Types

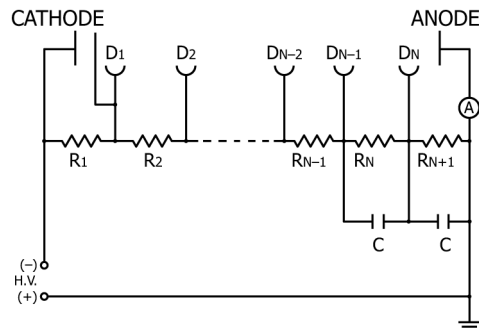

FIG. 4 Voltage-Divider Bridge