



Designation: F2291 – 23

Standard Practice for Design of Amusement Rides and Devices¹

This standard is issued under the fixed designation F2291; the number immediately following the designation indicates the year of original adoption or, in the case of revision, the year of last revision. A number in parentheses indicates the year of last reappraisal. A superscript epsilon (ϵ) indicates an editorial change since the last revision or reappraisal.

1. Scope

1.1 This practice establishes criteria for the design of amusement rides, devices and major modifications to amusement rides and devices manufactured after the effective date of publication except as noted in 1.2.

1.2 This practice shall not apply to:

1.2.1 Patron directed amusement rides or devices (for example, go karts, bumper cars, bumper boats),

1.2.2 Artificial climbing walls,

1.2.3 Air-supported structures,

1.2.4 dry slides,

1.2.5 coin operated rides,

1.2.6 Amusement rides or devices that involve the purposeful immersion of the patron's body partially or totally in the water and involves more than incidental patron water contact (for example, pools, water slides, lazy rivers, interactive aquatic play devices),

1.2.7 Amusement rides and devices whose design criteria are specifically addressed in another ASTM standard,

1.2.8 Portions of an amusement ride or device unaffected by a major modification,

1.2.9 Upgrades to electrical wiring, electrical motors and electrical components of amusement rides and devices provided the original design and safety criteria are maintained or enhanced, and

1.2.10 Pre-existing designs manufactured after the effective date of publication of this practice if the design is service proven or previously compliant and the manufacturer provides:

1.2.10.1 A historical summary of the amusement ride, device or major modification, and

1.2.10.2 A statement that the design is service proven or previously compliant as specified by Section 3.

1.2.10.3 Amusement rides and devices, and major modifications to amusement rides and devices may qualify as "previously compliant" for five years following the date of publication of this practice. Thereafter, amusement rides and devices, and major modifications to amusement rides and

devices must qualify as "service proven" or meet the requirements of this practice.

1.3 This practice includes an annex (mandatory), which provides additional information (for example, rationale, background, interpretations, drawings, commentary, and so forth) to improve the user's understanding and application of the criteria presented in this practice. The annex information shall be interpreted as mandatory design criteria.

1.4 This practice includes an appendix (non-mandatory), which provides additional information (for example, rationale, background, interpretations, drawings, commentary, and so forth.) to improve the user's understanding and application of the criteria presented in this practice. The appendix information shall not be interpreted as mandatory design criteria.

1.5 *Units*—The values stated in inch-pound units are to be regarded as standard. The values given in parentheses are mathematical conversions to SI units that are provided for information only and are not considered standard.

1.6 *This standard does not purport to address all of the safety concerns, if any, associated with its use. It is the responsibility of the user of this standard to establish appropriate safety, health, and environmental practices and determine the applicability of regulatory limitations prior to use.*

1.7 *This international standard was developed in accordance with internationally recognized principles on standardization established in the Decision on Principles for the Development of International Standards, Guides and Recommendations issued by the World Trade Organization Technical Barriers to Trade (TBT) Committee.*

2. Referenced Documents

2.1 *ASTM Standards:*²

F770 Practice for Ownership, Operation, Maintenance, and Inspection of Amusement Rides and Devices

F1193 Practice for Quality, Manufacture, and Construction of Amusement Rides and Devices

F2137 Practice for Measuring the Dynamic Characteristics of Amusement Rides and Devices

¹ This practice is under the jurisdiction of ASTM Committee F24 on Amusement Rides and Devices and is the direct responsibility of Subcommittee F24.24 on Design, Manufacture, Installation and commissioning.

Current edition approved June 1, 2023. Published July 2023. Originally approved in 2003. Last previous edition approved in 2022 as F2291 – 22a. DOI: 10.1520/F2291-23.

² For referenced ASTM standards, visit the ASTM website, www.astm.org, or contact ASTM Customer Service at service@astm.org. For *Annual Book of ASTM Standards* volume information, refer to the standard's Document Summary page on the ASTM website.

F2374 Practice for Design, Manufacture, Operation, and Maintenance of Inflatable Amusement Devices

2.2 *ASTM Technical Publication:*³

STP-1330 Composite Materials: Fatigue and Fracture, 7th Volume

2.3 *ACI Standards:*⁴

ACI-301 Specifications for Structural Concrete

ACI-318 Building Code Requirements for Structural Concrete (ACI-318) and Commentary (318R)

2.4 *AFPA, American Wood Council Standard:*⁵

NDS National Design Standard for ASD Design

NDS 2005 National Design Specification for Wood Construction

2.5 *AISC Manuals:*⁶

AISC 316 Manual on Steel Construction, Allowable Stress Design (ASD)

AISC M015 Manual on Steel Construction, Load & Resistance Factor Design (LRFD)

2.6 *ANSI Standards:*⁷

ANSI/AISC 360-16 Specifications for Structural Steel Buildings

ANSI B93.114M Pneumatic Fluid Power—Systems Standard for Industrial Machinery

ANSI B77.1 Passenger Ropeways—Aerial Tramways, Aerial Lifts, Surface Lifts, Tows and Conveyors—Safety Requirements

ANSI Y32.10 Graphic Symbols for Fluid Power Diagrams

2.7 *ASCE Standard:*⁸

ASCE 7 Minimum Design Loads for Buildings and Other Structures

ASCE 16 Standard for Load and Resistance Factor Design (LRFD) for Engineered Wood Construction

ASCE/SEI 7-22 Minimum Design Loads for Buildings and Other Structures

2.8 *ASM Documents:*⁹

ASM Atlas of Fatigue Curves

2.9 *ASME Standards:*¹⁰

ASME Boiler and Pressure Vessel Code

ASME B15.1 Safety Standards for Mechanical Power Transmission Apparatus

ASME A17.1 Safety Code for Elevators and Escalators

2.10 *AWS Standards:*¹¹

ANSI/AWS D1.1/D1.1M Structural Welding Code—Steel

2.11 *BSI Standards:*¹²

BS 5400-10 Steel, Concrete and Composite Bridges—Code of Practice for Fatigue

2.12 *Building Codes:*

International Building Code (2018) Chapter 16, “Structural Design”

National Building Code of Canada (2015) Companion-action load combinations

2.13 *CDC (Center for Disease Control) Growth Charts:*¹³
CDC Basic Body Measurements

2.14 *EN Standards:*¹⁴

EN 280 Mobile Elevating Work Platforms—Design Calculations, Stability Criteria, Construction, Safety, Examinations, and Tests

EN 1990 Eurocode 0: Basis of structural design

EN 1991 Eurocode 1: Actions on structures

EN 1993 Eurocode 3: Design of steel structures

EN 1995 Eurocode 5: Design of timber structures

2.15 *Factory Mutual Standard:*¹⁵

FM6930 Flammability Classification of Industrial Fluids

2.16 *Federal Documents:*

FMVSS No. 213 Child Restraint Systems¹⁶

OSHA 29 CFR PART 1926.502 (d) Fall protection systems criteria and practices. Personal fall arrest systems.¹⁷

USDA-72 U.S. Dept. of Agriculture, The Wood Handbook—Wood As An Engineering Material, Forest Service, Forest Products Laboratory¹⁸

2.17 *ISO Standards:*¹⁹

ISO 4113 Road Vehicles – Calibration Fluid for Diesel Injection Equipment Second Edition

ISO 4413 Hydraulic fluid power – General rules relating to systems

ISO 4414 Pneumatic Fluid Power General Rules Relating to Systems

ISO 4406 Particle Count Chart

ISO 6149-1 Connections for hydraulic fluid power and general use – Ports and stud ends with ISO 261 metric threads and O-ring sealing – Part 1: Ports with truncated housing for O-ring seal

ISO 7250 Basic Human Body Measurements for Technological Design

ISO 13850 Safety of Machinery – Emergency Stop – Principles for Design

³ Available from ASTM International Headquarters, 100 Barr Harbor Drive, PO Box C700, West Conshohocken, PA 19428-2959.

⁴ Available from American Concrete Institute (ACI), P.O. Box 9094, Farmington Hills, MI 48333.

⁵ Available from American Forest and Paper Association (AF&PA), 1111 19th St., NW, Suite 800, Washington, DC 20036.

⁶ Available from American Institute of Steel Construction (AISC), One E. Wacker Dr., Suite 3100, Chicago, IL 60601-2001.

⁷ Available from American National Standards Institute (ANSI), 25 W. 43rd St., 4th Floor, New York, NY 10036.

⁸ Available from The American Society of Civil Engineers (ASCE), 1801 Alexander Bell Dr., Reston, VA 20191.

⁹ Available from American Society of Metals (ASM International), 9639 Kinsman Rd., Materials Park, OH 44073-0002.

¹⁰ Available from American Society of Mechanical Engineers (ASME), ASME International Headquarters, Three Park Ave., New York, NY 10016-5900.

¹¹ Available from The American Welding Society (AWS), 550 NW LeJeune Rd., Miami, FL 33126.

¹² Available from British Standards Institute (BSI), 389 Chiswick High Rd., London W4 4AL, U.K.

¹³ Available from Centers for Disease Control & Prevention (CDC), 1600 Clifton Rd., Atlanta, GA 30333, website: <http://www.cdc.gov/> [Search: anthropometrics].

¹⁴ Available from European Committee for Standardization (CEN), 36 rue de Stassart, B - 1050 Brussels.

¹⁵ Available from FM Global at <http://www.fmglobal.com/default.aspx>.

¹⁶ Available from National Highway Traffic Safety Administration (NHTSA), 1200 New Jersey Ave., SE, West Building, Washington, DC 20590, <http://www.nhtsa.gov>.

¹⁷ Available from Occupational Safety and Health Administration (OSHA), 200 Constitution Ave., NW, Washington, DC 20210, <http://www.osha.gov>.

¹⁸ Available from U.S. Government Printing Office Superintendent of Documents, 732 N. Capitol St., NW, Mail Stop: SDE, Washington, DC 20401.

¹⁹ Available from International Organization for Standardization (ISO), 1 rue de Varembe, Case postale 56, CH-1211, Geneva 20, Switzerland.

2.18 *Military Standards*:²⁰

MIL 17 The Composite Materials Handbook

2.19 *NEMA Standard*:²¹

NEMA 250 Enclosures for Electrical Equipment

2.20 *NFPA Standards*:²²

NFPA-79 Electrical Standard for Industrial Machinery

NFPA-70 National Electric Code (NEC)

NFPA-101 Life Safety Code

2.21 *National Fluid Power Association, Inc. Document*:²³

NFPA/JIC T2.25.1M Pneumatic Fluid Power—Systems Standard for Industrial Machinery

NFPA/T2.24.1 Hydraulic Fluid Power - Systems Standard for Stationary Industrial Machinery Supplement to ISO 4413; 1998 - Hydraulic Fluid Power - General Rules Relating to Systems

2.22 *SAE Standards*:²⁴

SAE 100R4

SAE J518 Hydraulic Flanged Tube, Pipe, and Hose Connections, Four-Bolt Split Flange Type

SAE J833 Human Physical Dimensions

SAE J1926 Connections for General Use and Fluid Power-Ports and Stud Ends with ASME B1.1 Threads and O-Ring Sealing Part 3: Light-Duty (L-Series) Stud Ends

SAE HS 4000 Fastener Standards

2.23 *UL Standards*:²⁵

UL 508A Industrial Control Panels

3.1.6 *filter corner frequency (Fn)*—with reference to a low-pass filter, Fn is the frequency (specified in Hz) where the frequency response curve of the filter has magnitude of -3 dB.

3.1.7 *force limiting*—when pertaining to restraints, a characteristic that, regardless of the amount of force available from the system actuators, limits the amount of force applied to the patron(s).

3.1.8 *latching*—when pertaining to restraints, held secure against opening except by intentional action of the patron, operator, or other means. This can include restraints (for example, drop bars) held in place by gravity, detents or other means.

3.1.9 *locking*—when pertaining to restraints, held securely against opening except by intentional action of the operator or other means not accessible by the patron.

3.1.10 *manual release*—when pertaining to restraints, a hand or foot operated mechanism that allows for opening the patron restraint.

3.1.11 *manufacturer*—party producing the amusement ride or device, performing major modifications and can include the designer/engineer.

3.1.12 *operating mode*—a defined behavior of an amusement ride or device with a corresponding set of rules or interlocks that are implemented in control systems as required.

3.1.13 *patron clearance envelope*—patron reach envelope plus a margin of 3 in. (76 mm).

3.1.14 *patron containment*—features in an amusement ride or device that accommodate the patron for the purpose of riding the ride or device. This may include but is not limited to the seats, side walls, walls, or bulkheads ahead of the patron(s), floors, objects within the vicinity of the patron(s), restraint systems, and cages.

3.1.15 *patron reach envelope*—space a patron could reach during a ride cycle while properly positioned, as defined by the ride analysis, in the amusement ride or device and limited only by the vehicle, seat geometry, and restraint system.

3.1.16 *previously compliant*—amusement ride or device, or major modification to an amusement ride or device, of which the design meets the ASTM Standard in place at the time of its design.

3.1.17 *primary circulation area*—areas leading directly to the entrance and exit of a ride that are normally traveled by patrons. These areas would not include emergency exit routes, maintenance areas, or other areas not normally on the route of the patron.

3.1.18 *restraint*—system, device, or characteristic that is intended to inhibit or restrict the movement of the patron(s) while on the amusement ride or device.

3.1.19 *safety-related control system (SRCS)*—an assembly of components that monitor and control the amusement ride or device such that it: (1) mitigates hazards to persons; or (2) has the capability to block or otherwise alter the performance of systems that implement safety features. Components may include without limitation electronic, electric, electro-mechanical, hydraulic, pneumatic or mechanical devices, or combinations thereof.

3. Terminology

3.1 *Definitions of Terms Specific to This Standard*:

3.1.1 *acceleration, impact*—those accelerations with duration of less than 200 ms.

3.1.2 *acceleration, sustained*—those accelerations with duration greater than or equal to 200 ms.

3.1.3 *control station*—a location where buttons, switches or other controls are provided for the purpose of operating ride equipment.

3.1.4 *designer/engineer*—party(s) that establishes and describes the configuration of the amusement ride or device, establishes strength and fatigue life, designs and develops electrical/electronic control systems, and defines inspection criteria.

3.1.5 *fail-safe*—characteristic of an amusement ride or device, or component thereof, that is designed such that the normal and expected failure mode results in a safe condition.

²⁰ Available from Standardization Documents Order Desk, DODSSP, Bldg. 4, Section D, 700 Robbins Ave., Philadelphia, PA 19111-5098

²¹ Available from National Electrical Manufacturers Association (NEMA), 1300 N. 17th St., Suite 1847, Rosslyn, VA 22209.

²² Available from National Fire Protection Association (NFPA), 1 Batterymarch Park, Quincy, MA 02269-9101.

²³ Available from National Fluid Power Association, Inc., 3333 N. Mayfair Rd., Milwaukee, WI 53222-3219.

²⁴ Available from Society of Automotive Engineers (SAE), 400 Commonwealth Dr., Warrendale, PA 15096-0001.

²⁵ Available from Underwriters Laboratories (UL), Corporate Progress, 333 Pfingsten Rd., Northbrook, IL 60062.

3.1.20 *service proven*—an amusement ride, device, or major modification to an amusement ride or device of which (1) unit(s) have been in service to the public for a minimum of five years, and (2) unit(s) that have been in service have done so without any significant design related failures or significant design related safety issues that have not been mitigated.

3.1.21 *service proven practice*—a policy or procedure used in association with an amusement ride or device, which (1) has been in service to the public for a minimum of five years, and (2) has done so without any significant safety related issues that have not been mitigated.

3.1.22 *supervising companion*—a person on a ride or device who is qualified by a reasonable age or other means to understand rider instructions, assist a patron or child under 48 in. (1.22 m) in height in complying with rider instructions, and who meets all other criteria for riding.

3.1.23 *use case*—a purpose for which equipment is used by persons or external systems. Examples of common use cases include but are not limited to entertaining patrons, supporting routine maintenance, and programming for creative intent. Use cases and operating modes may or may not have a one-to-one correspondence.

3.1.24 *zone of operator awareness*—area defined by the sights, sounds, and other stimuli an operator can reasonably be expected to monitor from their specified location(s) relative to the amusement ride or device that they are operating. The zone of operator awareness could include multiple, noncontiguous portions of a ride-vehicle path. Information provided by remote audio or video monitoring devices may be part of the zone of operator awareness.

4. Significance and Use

4.1 The purpose of this practice is to provide designers, engineers, manufacturers, owners, and operators with criteria and references for use in designing amusement rides and devices or a major modification for amusement rides or devices.

5. General Design Criteria

5.1 Ride Analysis:

5.1.1 The designer/engineer shall perform and document a ride analysis that illustrates how hazards to persons have been managed. The documentation shall include but not be limited to the following:

5.1.1.1 An identification of the scope of the analysis. The scope shall describe the equipment considered by the analysis. The scope shall identify the use cases of the amusement ride or device. The scope may be clarified by identifying excluded equipment or scenarios.

5.1.1.2 An identification of hazards that includes potential sources and consequences of harm.

5.1.1.3 An identification of hazardous scenarios.

(1) Hazardous scenarios shall consider physical areas where persons are expected to access.

(2) Hazardous scenarios shall consider exposure to hazards under all identified use cases.

(3) Hazardous scenarios related to maintenance personnel actions shall be restricted to routine, repetitive and essential procedures.

5.1.1.4 An assessment of hazards that includes a description of how identified hazards are mitigated to an acceptable level. Hazards are mitigated by reducing the severity of the hazard, reducing the probability of occurrence of related hazardous scenarios, or both. Not all hazards require mitigation. The assessment of hazards shall consider hazards that are created or aggravated by the means of mitigation and the potential for failure of the means of mitigation. This assessment shall include but not be limited to the following:

(1) *Patron Suitability Assessment*—A patron suitability assessment shall describe the suitability of the design of the amusement ride or device for the intended patrons, including anthropometric factors that relate age and physical size.

(2) *Patron Restraint and Containment Analysis*—A patron restraint and containment analysis shall be performed in accordance with Section 6.

(3) *Patron Clearance Envelope Analysis*—A patron clearance envelope analysis shall be performed in accordance with Section 6.

(4) *Load/Unload Areas Activities Analysis*—A load/unload areas analysis shall describe how the attraction's design addresses risk associated with activities that are performed in the primary load/unload areas of the amusement ride or device. (See [Appendix X9](#) for examples of strategies.)

(5) *Failure Analysis*—A failure analysis shall be performed on the safety related systems of the amusement ride or device. The failure analysis shall include either a Fault Tree Analysis, a Failure Mode and Effects Analysis (FMEA), or other accepted engineering practices.

(6) *Environmental Conditions*—The environmental conditions to which the amusement ride or device is designed to be subjected shall be included in the hazard assessment.

(7) *Evacuation Analysis*—A patron evacuation analysis for the amusement ride or device shall be performed. The Evacuation Analysis shall include information specific to the amusement ride or device to support the Owner/Operator in developing an Evacuation Plan per Practice [F770-21a](#) Section 6.2 Evacuations.

5.2 Hazard Mitigations:

5.2.1 Hazard mitigations shall consider:

5.2.1.1 The anticipated lifetime of safety related systems and components as identified in the Ride Analysis, based on their expected use;

5.2.1.2 The potential deterioration of safety-related components, as identified in the Ride Analysis, due to the environmental conditions identified in the hazard assessment; and

5.2.1.3 The means and methods for detecting component failures. Detection methods include but are not limited to automatic detection by a control system, periodic operational testing, and periodic inspection of components including non-destructive testing.

5.2.2 Hazard mitigations that involve safety-related control functions shall consider and identify:

5.2.2.1 System response/reaction time,

5.2.2.2 Tolerance limits for parameters (for example, speed, distance, force), and

5.2.2.3 Reliability, redundancy, and performance characteristics.

5.2.3 Hazard mitigations that involve operator responsibilities to perform actions shall:

5.2.3.1 Identify operator responsibilities and actions related to hazard mitigation and system responses to those actions.

5.2.3.2 Consider the specified operator responsibilities related to hazard mitigations in combination with other reasonably anticipated operator responsibilities.

5.2.4 Hazard mitigations that involve operator procedures, or involve routine, repetitive, and essential maintenance procedures shall:

5.2.4.1 Identify the frequency of the procedures, and

5.2.4.2 Define the elements that must be included in the documented procedures in order to make those procedures effective with respect to associated hazards.

5.2.5 The design shall identify appropriate devices that allow the operator(s) to enable, intercept, or affect amusement ride or device operation considering the operator's specified responsibilities, specified location, and identified zone of operator awareness.

5.3 *Design and Calculations:*

5.3.1 The designer/engineer shall perform calculations showing compliance with the design criteria of this practice. Calculations and assessments of the following types are required.

5.3.1.1 Calculations verifying the adequacy of structural, mechanical, and electrical components.

5.3.1.2 Calculations of significant and predictable acceleration that is generated by the ride or device when operated as reflected in the manufacturer's provided operating and maintenance manuals or written instructions.

5.3.1.3 Performance and functional characteristics of control systems.

5.3.1.4 Calculations shall be performed using coordinate axis and load paths as defined by Practice **F2137** or the EN equivalent.

5.4 *Other Design Considerations*—Where water is a design element of the ride or of related ride effects and is intended to contact the equipment of the ride, the designer/engineer should consider water quality maintenance and treatment when determining materials for use in manufacture.

5.5 *Units:*

5.5.1 Units of measurement shall be clearly specified in all documentation.

5.5.2 The coordinate system shown in **Fig. 1** shall be used as the standard reference for acceleration directions, including the application of the different means of restraint in accordance with the criteria of the restraint diagram shown in **Fig. 2**.

5.6 *Drawings and Records:*

5.6.1 The designer/engineer or manufacturer shall produce and retain as-built drawings, calculations, and control software that depict the amusement ride, device, or major modification details. These drawings and calculations shall be retained for a minimum of 20 years from the date of last manufacture. In the

case of a major modification, only the records associated with that major modification, and not the entire ride or device, must be retained for a minimum of 20 years.

5.6.2 Documents deemed proprietary and confidential by the manufacturer shall include a statement of such on each document. Use of the manufacturer's documentation and records should be limited, where possible, to the installation, maintenance, inspection, and operation of the ride or device. All other dissemination should be limited.

5.6.3 Documentation supplied to the buyer, owner, or operator shall be complete and adequate for proper installation, maintenance, inspection, and operation of the amusement ride, device, or major modification.

5.6.4 Drawings and documents shall illustrate and define all important dimensions and tolerances. Dimensions, tolerances, and other important characteristics shall be clearly depicted in appropriate views and cross sections. The following shall be included:

5.6.4.1 General drawings or diagrams in plan, elevation, and section views showing the general arrangement of components, including patron clearance envelope as described in Section **6** of this practice.

5.6.4.2 Assembly and subassembly drawings providing additional views of areas not clearly discernible from the general drawings and providing clear identification and specification of all included components, their locations, and other information as applicable, for example, proper adjustment(s), fastener tightening specifications, descriptions of any other materials or lubricants used, and other important information.

5.6.4.3 Detailed drawings of all components specifically manufactured for use in the amusement ride, device, or major modification.

5.7 *Regulatory Body Review Documents:*

5.7.1 When the approval of the amusement ride, device, or major modification design is required by a regulatory authority, the following documents are typically made available for review:

5.7.1.1 General assembly drawings,

5.7.1.2 Facility interface drawings and related load calculations,

5.7.1.3 Operations, maintenance, and assembly instructions, and

5.7.1.4 Information otherwise called for in accordance with the guidelines in Practice **F1193**.

5.7.2 Use of the manufacturer's documentation and records should be limited to the regulatory approval process and dissemination shall be limited to minimize disclosure of proprietary and confidential documents.

6. **Patron Restraint, Clearance Envelope, and Containment Design Criteria**

6.1 *Patron Containment:*

6.1.1 The amusement ride or device shall be designed to support and contain the patron(s) during operation. This support and containment, that is, the patron containment, shall be consistent with the intended action of the ride or device.

6.1.2 Parts of amusement rides and devices that patrons may reasonably be expected to contact shall be smooth; free from

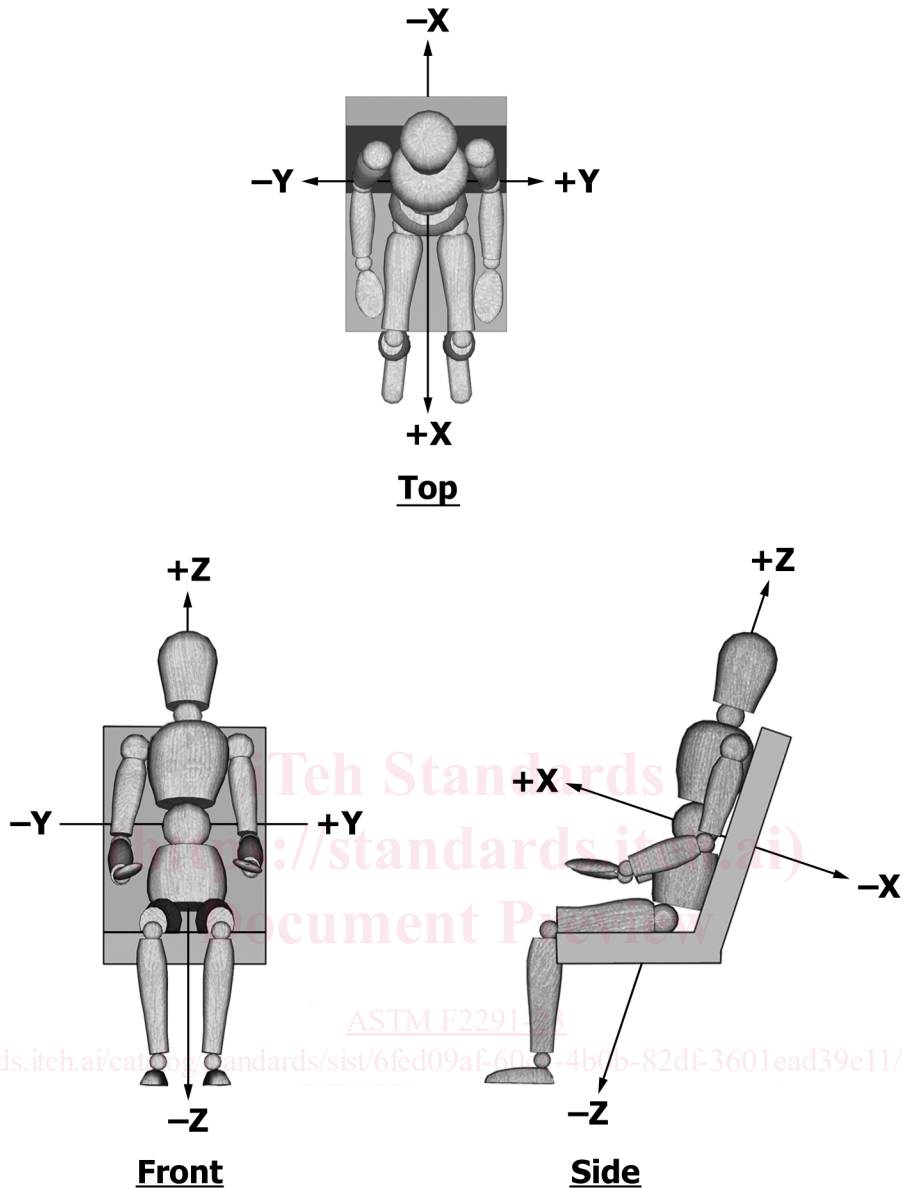

FIG. 1 Patron Coordinate System

unprotected protruding studs, bolts, screws, sharp edges and corners, and rough or splintered surfaces; and considered for padding as appropriate.

6.1.3 For devices lacking a ride vehicle or patron carrier, consideration shall be given to measures that prevent or mitigate injuries potentially caused by collisions as determined by the ride analysis and patron restraint and containment analysis.

6.1.4 *Ride or Device Vehicle Doors:*

6.1.4.1 When amusement ride or device patron vehicles are provided with doors, measures shall be taken to ensure that the doors do not open during operation, failure, or in case of emergency, unless otherwise determined by the ride analysis.

6.1.4.2 Powered doors shall be designed to minimize pinch points and entrapment areas. The doors' (opening and closing) movement shall be controlled, and the maximum exerted force,

measured on the edge of the door at the furthestmost point from the hinge or pivot, shall not exceed 30 lb (133 N).

6.2 *Security of Patron Containment System:*

6.2.1 Any system or systems used to support and contain the patron(s) shall be securely fixed to the structure of the ride or device and shall have adequate strength for the intended forces produced by the ride or device and the reasonably foreseeable actions of the patron(s).

6.3 *Patron Restraints:*

6.3.1 Patron restraints shall be provided as determined by the designer/engineer. This determination shall be based on the patron restraint and containment analysis performed in accordance with criteria defined in this practice and shall take into consideration the nature of the amusement ride or device and the intended adult or child patron physical characteristics,

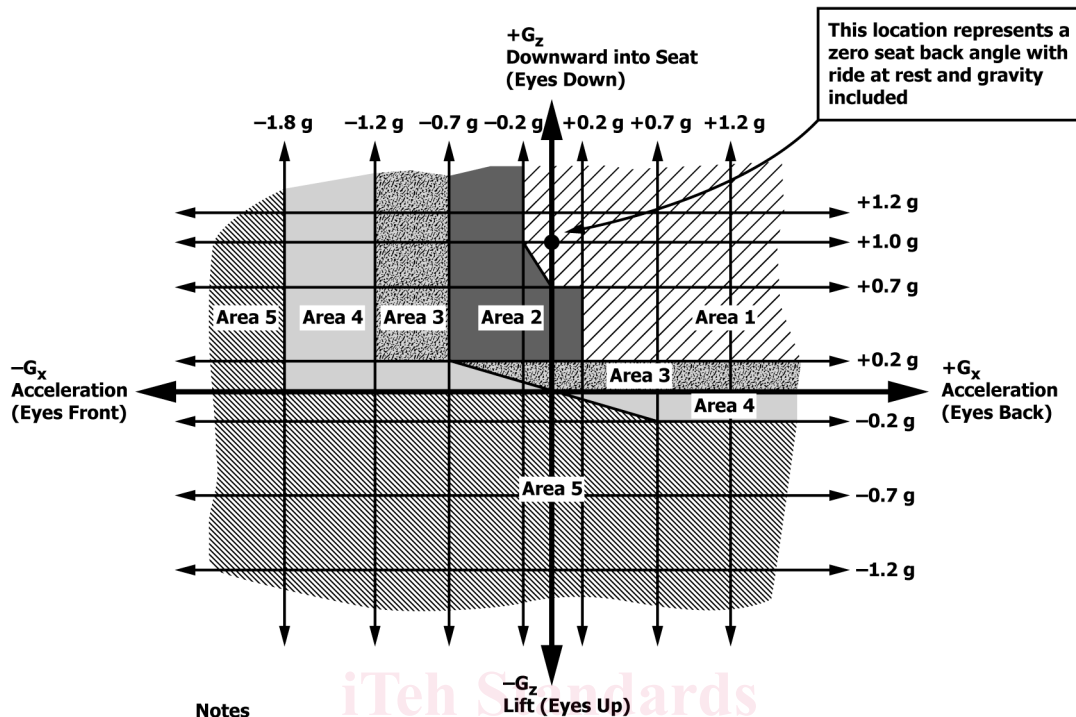

Notes

- 1) For cases on a boundary, the lower category may be chosen.
- 2) Accelerations are limited to the sustained values in section 7.
- 3) This diagram is intended for use with restraint systems where the patron begins the ride in the sitting or standing position (that is, spine nearly aligned with gravity).

FIG. 2 Restraint Determination Diagram—Accelerations in Design Stage

ASTM F2291-23

based on recognized and published anthropometric data such as Dreyfuss Human Scale 4/5/6 (1),²⁶ 7/8/9 (2), SAE J833, ISO 7250, or Center for Disease Control Growth Charts. The specific anthropometric data utilized shall be documented in the ride analysis. When evaluating anthropometric data to be used in design, the designer/engineer shall consider that the patron height requirement will be enforced as stated in Practice F770.

6.3.2 The patron restraint and containment analysis may identify the need for a restraint system for reasons other than acceleration or seat inclination. The analysis shall also evaluate the need for locking or latching functions when restraints are required.

6.3.3 The manufacturer shall take into consideration the evacuation of patrons from any reasonably foreseeable position or situation on the ride or device, including emergency stops and stops in unplanned locations. The patron restraint and containment analysis shall address whether individual or group restraints releases are appropriate.

6.3.4 The manufacturer shall specify the state, locked or unlocked, of the restraint system in the event of unintended

stop, for example, emergency stop or loss of power. This specification shall be based on the results of the ride analysis performed in 5.1.

6.3.5 Restraints shall be designed such that the opportunity for pinching or unintentional trapping of fingers, hands, feet, and other parts of the patron's body is minimized.

6.3.6 The maximum exerted force produced by any powered patron restraint while opening or closing shall not be more than 18 lb (0.08 kN), measured on the active surfaces contacting the patron. Force limiting systems, if used to achieve this, shall be configured so that the failure of any one element of that system will still result in force being limited to 18 lb (0.08 kN).

6.3.7 The manufacturer shall take into account the patron-induced loads, for example, bracing, etc., in addition to the loads and criteria specified in the Loads and Strengths section of this practice.

6.3.8 A manual restraint release shall be provided for authorized personnel use.

6.3.8.1 The manual release should be conveniently located and easily accessed by authorized personnel without crawling over or under or otherwise coming in direct contact with the patrons.

6.3.8.2 External or unmonitored internal nonmechanical stored energy, for example, battery, accumulator, hydraulic, or

²⁶ The boldface numbers in parentheses refer to the list of references at the end of this standard.

pneumatic, shall not be used for a manual release unless otherwise determined by the ride analysis.

6.3.8.3 Special tools shall not be required to operate the manual release, unless otherwise determined by the ride analysis.

6.3.9 When a latching or locking restraint is provided, the Patron Restraint and Containment Analysis shall evaluate the need for features such as contours, dividers, bolsters or other forms and shapes that aid in preventing patrons from sliding longitudinally or laterally outside of the restraint area.

6.4 *Restraint Configuration:*

6.4.1 *Restraints Required in Kiddie Rides:*

6.4.1.1 Where kiddie rides or devices do not provide a fully enclosed compartment (that is, so as to reject a 4 in. (102 mm) diameter sphere at all openings), a latching restraint shall be provided, unless the patron restraint and containment analysis indicate a locking restraint is needed or a restraint is not appropriate (for example, a kiddie canoe ride).

6.4.1.2 Where kiddie rides or devices provide either latching or locking restraints, the final latching or locking position of the restraint must be adjustable in relation to the patron(s).

6.4.1.3 When a latching restraint is used and a supervising companion is not required, the latching device must be difficult for a child Patron to open by virtue of its design or location, for example, beyond the child Patrons reach envelope or a “push to open” buckle with a release force of 9 lbf (40 N) or greater. A recognized test such as found in FMVSS No. 213 (October 1, 2004 edition, paragraph S6.2.1) may be used to determine release force.

6.4.2 *Restraints Required in or Supervision Required for Rides That Accommodate Both Children Under 48 in. (1.22 m) in Height and Adults:*

6.4.2.1 Amusement rides or devices intended to accommodate both children under 48 in. (1.22 m) in height and adults shall meet the requirements of 6.4.1 or employ other safeguards such as a supervising companion or other means determined by the ride analysis.

6.4.2.2 When a supervising companion is employed to accompany children under 48 in. (1.22 m) in height on rides that accommodate both children under 48 in. (1.22 m) in height and adults, the supervising companion must either:

- (1) Comply with a service proven practice of the operating facility which relates to qualifying supervising companions, or
- (2) Meet all the criteria for riding alone and be approximately 14 years of age or older. (See X7.2). A ride analysis may lead to alternate requirements.

6.4.3 *Restraints Required Due to Acceleration and Seat Inclination:*

6.4.3.1 Restraints shall be provided in cases where it is reasonably foreseeable that patrons could be lifted or ejected from their seats or riding positions by the acceleration of the amusement ride or device, or by seat inclination, during the ride or device cycle and other reasonably foreseeable situations, for example, the application of emergency brakes or vehicles stopped in inverted positions. Refer to X1.5 for further guidance on design considerations.

6.4.3.2 The restraint diagram shown in Fig. 2 shall be used as part the patron restraint and containment analysis for

determining if a restraint is required, and if required, what type. The restraint diagram identifies and graphically illustrates five distinctive areas of theoretical acceleration. Each of the five distinctive areas may require a different class of restraint as indicated in 6.5 of this practice. The restraint diagram applies for “sustained acceleration” levels only. It is not to be applied for “impact acceleration.”

6.4.3.3 *Restraint Criteria*—Referring to areas on the restraint determination diagram shown in Fig. 2, as a minimum, the following restraint classes shall be used (in all areas, a higher class restraint or individual requirements of a higher class restraint is permitted).

6.4.3.4 *Area-1*—A Class-1 restraint is defined as unrestrained or no restraint at all.

(1) Based solely on Area-1 dynamic forces, no restraint is required; however, other criteria in this practice (that is, the ride analysis) may require a higher class restraint.

6.4.3.5 *Area-2*—A Class-2 restraint is required unless patrons are provided sufficient support and the means to react to the forces, for example, handrails, footrest, or other devices. A Class-2 restraint is generally defined as a latching restraint for each individual patron or a latching collective restraint for more than one patron. A Class-2 restraint shall have at least the following:

(1) *Number of Patrons Per Restraint*—Individual patron or more than one patron.

(2) *Final Latching Position Relative to the Patron*—The final latching position may be fixed or variable in relation to the patron.

(3) *Type of Latching*—The patron or operator may latch the restraint.

(4) *Type of Unlatching*—The patron or operator may unlatch the restraint.

(5) *Restraint Position Monitoring*—No external indication is required.

(6) *Means of Activation*—The restraint may be manually or automatically (for example, motorized) opened and closed.

(7) *Redundancy of Latching Device*—Redundancy is not required.

6.4.3.6 *Area-3*—A Class-3 restraint is required. A Class-3 restraint is generally defined as a latching restraint for each individual patron or a latching collective restraint for more than one patron. A Class-3 restraint shall have at least the following:

(1) *Number of Patrons per Restraint*—Individual patron or more than one patron.

(2) *Final Latching Position Relative to the Patron(s)*—The final latching position must be variable in relation to the patron(s), for example, a bar or a rail with multiple latching positions.

(3) *Type of Latching*—The patron or operator may manually latch the restraint or it may be automatically latched. The manufacturer shall provide instructions that the operator shall verify the restraint is latched.

(4) *Type of Unlatching*—The patron may manually unlatch the restraint or the operator may manually or automatically unlatch the restraint.

(5) *Restraint Position Monitoring*—No external indication is required. The design shall allow the operator to perform a visual or manual check of the restraint position each ride cycle.

(6) *Means of Activation*—The restraint may be manually or automatically (for example, motorized) opened and closed.

(7) *Redundancy of Latching Device*—Redundancy is not required.

(8) *Monitoring of Latching Device*—The latching device shall be periodically tested prior to being put into operation with patron. The frequency and procedure of such a periodic test shall be determined by the designer/engineer.

6.4.3.7 *Area-4*—A Class-4 restraint is required. A Class-4 restraint is generally defined as a locking restraint for each individual patron. A Class-4 restraint shall have at least the following:

(1) *Number of Patrons per Restraint*—A restraint shall be provided for each individual patron.

(2) *Final Latching Position Relative to the Patron*—The final latching position of the restraint must be variable in relation to the patrons, for example, a bar or a rail with multiple latching positions.

(3) *Type of Locking*—The restraint shall be automatically locked.

(4) *Type of Unlocking*—Only the operator shall manually or automatically unlock the restraint.

(5) *Restraint Position Monitoring*—The design shall allow the operator to perform a visual or manual check of the restraint position each ride cycle.

(6) *Means of Activation*—The restraint may be manually or automatically (for example, motorized) opened or closed.

(7) *Redundancy of Locking Device*—Redundancy shall be provided for the locking device function.

(8) *Monitoring of Locking Device*—The locking device shall be periodically tested prior to being put into operation with patrons. The frequency and procedure of such a periodic test shall be determined by the designer/engineer.

6.4.3.8 *Area-5*—A Class-5 restraint is required. A Class-5 restraint is generally defined as a redundant locking restraint for each individual patron. A Class-5 restraint shall have at least the following:

(1) *Number of Patrons per Restraint*—A restraint shall be provided for each individual patron.

(2) *Final Latching Position Relative to the Patron*—The final latching position of the restraint must be variable in relation to the patrons, for example, a bar or a rail with multiple latching positions.

(3) *Type of Locking*—The restraint shall be automatically locked.

(4) *Type of Unlocking*—Only the operator shall manually or automatically unlock the restraint.

(5) *Restraint Position Monitoring*—An external indication is required. Detecting the failure of any monitored device shall either bring the ride to a cycle stop or inhibit cycle start. The design shall allow the operator to perform a visual or manual check of the restraint position each ride cycle.

(6) *Means of Activation*—The restraint may be manually or automatically (for example, motorized) opened or closed.

(7) *Redundancy of Locking Device*—Redundancy shall be provided for the locking device function.

(8) *Monitoring of Locking Device*—The locking device shall be periodically tested prior to being put into operation with patrons. The frequency and procedure of such a periodic test shall be determined by the designer/engineer.

(9) *Restraint Configuration*—Two restraints, for example, upper torso and lap bar or one fail-safe restraint is required.

6.4.3.9 *Secondary Restraints for Class 5*—A Class-5 restraint configuration may be achieved by the use of two independent restraints or one fail-safe restraint. When two independent restraints are used, the secondary restraint shall have the following minimum characteristics:

(1) *Number of Patrons per Restraint*—Individual patron or more than one patron.

(2) *Final Latching Position Relative to the Patron*—The final latching position may be fixed or variable in relation to the patron.

(3) *Type of Locking*—Only the operator may manually or automatically lock the restraint.

(4) *Type of Unlocking*—Only the operator shall manually or automatically unlock the restraint.

(5) *Restraint Position Monitoring*—No external indication is required other than a visual check of the restraint position itself.

(6) *Means of Activation*—The restraint may be manually or automatically (for example, motorized) opened or closed.

(7) *Redundancy of Locking Device*—The locking and unlocking of the secondary restraint shall be independent of the primary restraint.

6.4.4 *Other Restraint Considerations:*

6.4.4.1 The application of the restraint diagram is intended as a design guide. The ride analysis or other factors or requirements of this practice may indicate the need to consider another class of restraint (either higher or lower). Any special situation needs to be taken into consideration in designing the restraint system. These may include:

(1) Duration and magnitude of the acceleration,

(2) Height of the patron-carrying device above grade or other objects,

(3) Wind effects,

(4) Unexpected stopping positions of the patron units, for example, upside down,

(5) Lateral accelerations, for example, where sustained lateral accelerations are equal to or greater than 0.5 g, special consideration shall be given to the design of seats, backrest, headrest, padding, and restraints, and

(6) The intended nature of the amusement ride or device.

6.4.4.2 When the ride analysis indicates that there is a significant risk in restraining guests, for example, in log flume ride vehicles that may swamp or overturn, and the methods of patron containment specified in the restraint diagram for fore/aft accelerations would create a hazard, it is acceptable to use other methods or a combination of other methods such as patron separation devices, padding, handrails or footrests as determined by the ride analysis.

6.5 The physical information provided in accordance with Practice **F1193** shall be consistent with the patron restraint system, if any.

6.6 *Patron Clearance Envelope Analysis:*

6.6.1 Amusement rides and devices shall be designed to provide a patron clearance envelope adequate to minimize the opportunity for contact between the patron and other objects where said contact is likely to cause injury.

6.6.2 Where surrounding surfaces or objects are allowed within the patron clearance envelope of an amusement ride or device, reasonably appropriate measures shall be taken to ensure that those surfaces or objects are configured to avoid hostile features such as splinters, sharp or sharply angled features or edges, protruding items, pinch points, or entrapment areas. This requirement is especially important in a ride or device load/unload area where patron control and assistance devices are provided. The ride analysis shall specifically address these issues.

6.6.2.1 When the design of an amusement ride and device allows patron-to-patron contact (for example, while seated in separate vehicles), the designer/engineer shall take reasonably appropriate steps to ensure that the potential contact is appropriate for the amusement ride or device's intended use and the intended patron experience.

6.6.3 The designer/engineer shall determine the shape and size of the required patron clearance envelope based on the appropriate patron model, the patron reach envelope, and the design of the patron containment system, if any. The minimum patron model shall be based on the physical characteristics for a 95th percentile male patron, adult or child, based on recognized and published anthropometric data, such as Dreyfuss Human Scale 4/5/6 (1), 7/8/9 (2), SAE J833, ISO 7250, or Center for Disease Control Growth Charts, with an additional (extended) arm and leg reach of not less than 3 in. (76 mm) (effectively a 99.9th percentile) male, adult or child, as appropriate (see Section 2). The specific anthropometric data utilized shall be documented in the ride analysis. The following shall be considered:

6.6.3.1 The intended patron size and height and any designer/engineer specified restriction for minimum or maximum patron height.

6.6.3.2 The shape(s) and configuration of the patron containment system, including:

- (1) Seats, armrest, seat back and sides, foot well, or other,
- (2) Associated restraint system(s), if provided, for example, lap bar, seat belt, upper torso restraint, cage, or other, and
- (3) The ability, as limited by the patron containment, of the patron to extend any part of their body, for example, arms and legs, through vehicle openings or outward or upward, or both, beyond the perimeters of the vehicle, including the ability to extend arms upward due to the translation of the shoulder joint. See Appendix **X7.3** for additional information.

6.6.3.3 The physical nature of surrounding objects or surfaces that might otherwise be contacted, for example, sharp, hard, rough or abrasive, ability to snag or trap and hold, or other attributes that may produce undesirable contact for the patrons of the ride or device.

6.6.3.4 The relative speeds and directions that contact might take place.

6.6.3.5 The reasonably foreseeable changes that are likely to occur in the location or nature of the surroundings, for example, other adjacent moving vehicles or objects and their physical nature and speeds.

6.6.3.6 The possibility of variations in the position or orientation of the patron carrying device, (for example, angular movement, side movement, unrestrained or undamped motion, or free swinging).

6.6.4 The designer/engineer or manufacturer shall determine a means by which direct measurement may be taken to confirm that the intended patron clearance envelope is attained in the completed amusement ride or device assembled in its operating location.

6.6.4.1 The determined means for direct measurements shall include points from which measurements may be taken. The locations of these points shall be illustrated with appropriate drawings in the manufacturer provided instructions or they may be physical markers on the amusement ride or device.

6.6.4.2 The determined means for direct measurements and the patron clearance envelope shall be shown in a convenient form and illustrated both graphically and numerically. Illustrations similar to **Figs. 3-5** are one acceptable method.

6.6.5 Any moveable system or device designed to temporarily encroach on the patron clearance envelope, that is, loading/unloading platforms, decks, or other devices, shall be designed in a fail-safe manner in order to prevent unintended contact.

6.7 *Signage*—The manufacturer shall determine and may make recommendations for appropriate advisory signs or warning signs based on the attributes of the amusement ride or device. These recommendations should be clear and concise, but are not intended to be the final wording of the signs that may be generated and displayed at the ride or device.

7. Acceleration Limits

7.1 *Acceleration Limits:*

7.1.1 Amusement rides and devices shall be designed such that the ride dynamics, when measured as provided herein, are within the limits specified in this practice. The design acceleration levels of the final operational assembly of a newly developed amusement ride, device, or major modification shall be verified at commissioning by testing. Test data intended for evaluation against the limits specified in this practice shall be acquired and prepared as follows:

7.1.1.1 The data shall be acquired in accordance with the provisions of the Standard Amusement Ride Characterization (SARC) test, as specified in Section 12 of Practice **F2137 – 19**. For testing performed subsequent to commissioning testing and when determined to be acceptable by the designer, engineer or a biodynamic expert, it is permissible to vary the testing ballast weight from that specified in the Practice **F2137 – 19** SARC test. The testing ballast weight variation shall be documented in the test data record.

7.1.1.2 The acquired test data shall be post-processed, with a 4-pole, single pass, Butterworth low pass filter using a corner frequency (F_n) of 5 Hz.

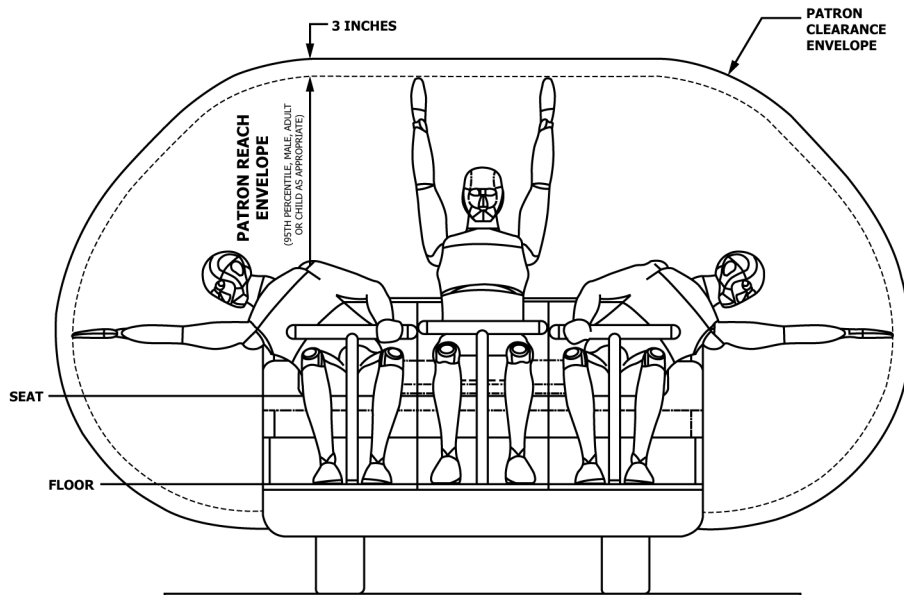

FIG. 3 Sample Patron Clearance Envelope Illustration Front View Configuration

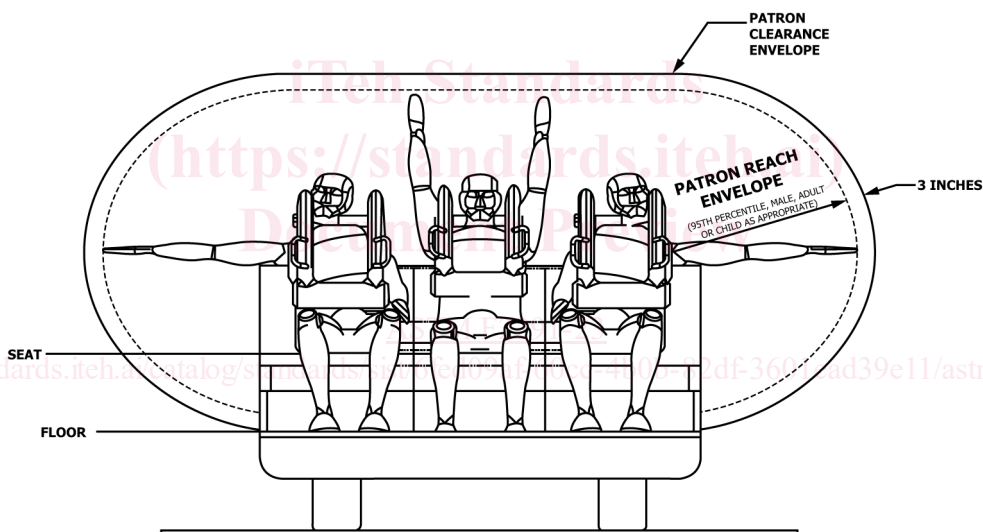

FIG. 4 Sample Patron Clearance Envelope Illustration Front View Configuration

7.1.1.3 Evaluate the post-processed test data against the acceleration limits herein by using either manual (for example, graphic, hand calculations, etc.) or automatic (for example, computational, computer, etc.) procedures.

7.1.2 Amusement rides and devices or major modifications that are designed to operate outside the acceleration limits herein shall include justification in the ride analysis. The justification shall include a review by a biodynamic expert.

7.1.3 Accelerations shall be coordinated with the intended physical orientation of the patron during the operating cycle. Amusement rides and devices with patron containment systems shall be designed such that the patron is suitably contained and positioned to accept these accelerations. The patron restraint and containment analysis shall be used to determine the type of restraint. The designer/engineer shall consider cases related to

patron position within the restraint in the patron restraint and containment analysis. Fig. 1 illustrates the coordinate system utilized.

NOTE 1—Accelerations vary greatly depending on the type and design of the amusement ride or device, and the effect of these accelerations is dependent on many factors that may be considered in the design (see Appendix X2).

7.1.4 Sustained acceleration duration limits are shown in this section (see Figs. 6-8). The following definitions apply:

7.1.4.1 Acceleration units are “g” (32.2 ft/s/s or 9.81 m/s/s).

7.1.4.2 The sustained acceleration duration limits of this section (Figs. 6-8) do not address impacts of less than 200 ms duration. A method for considering the biodynamic effect of impact events is contained in Appendix X11.

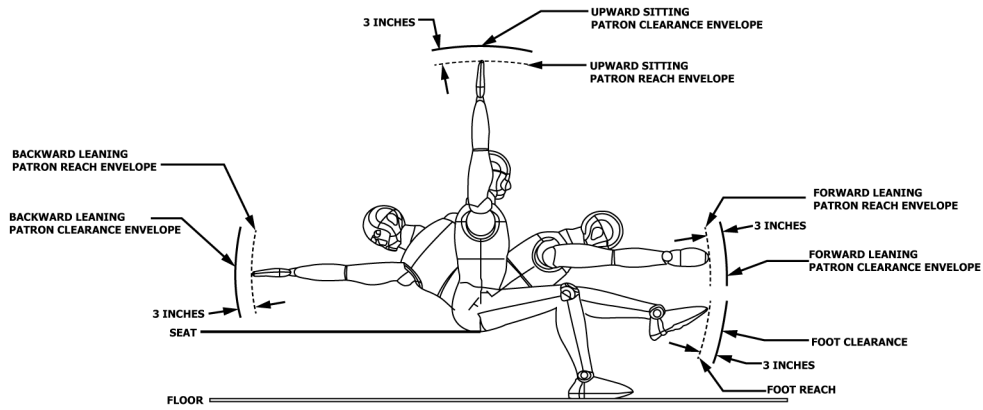

FIG. 5 Sample Patron Clearance Envelope Illustration Side View Configuration

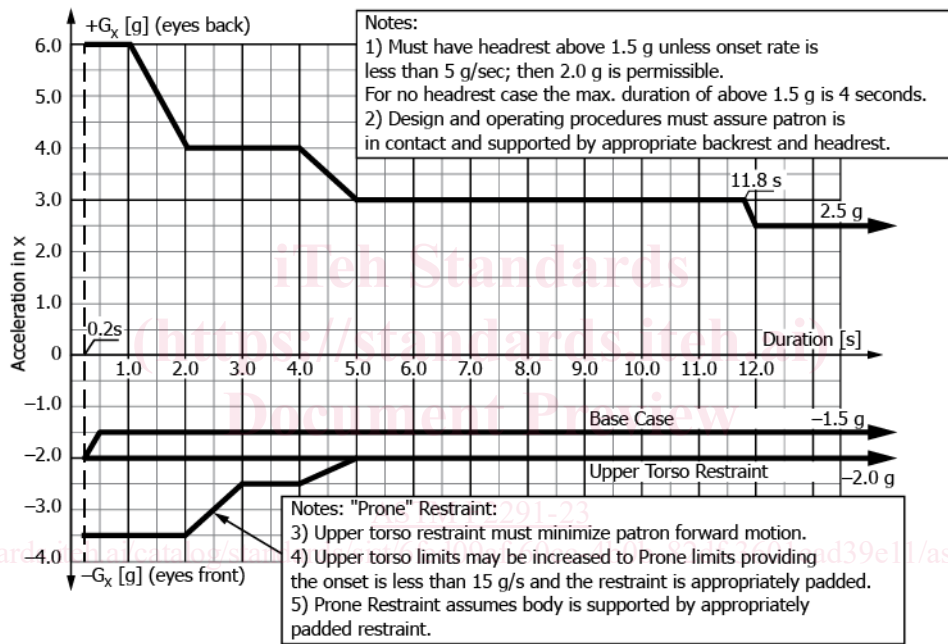

FIG. 6 Acceleration-Duration Limits for Gx (Eyes Front and Eyes Back)

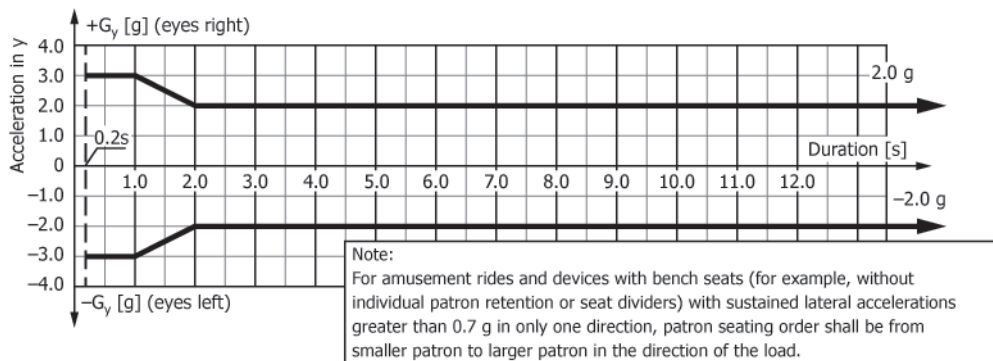

FIG. 7 Acceleration-Duration Limits for Gy (Eyes Right and Eyes Left)

7.1.4.3 The designer/engineer shall determine whether the acceleration limits herein, or more restrictive limits, are appropriate for an amusement ride or device that accommodates

patrons under 48 in. (1.22 m) in height. In making this

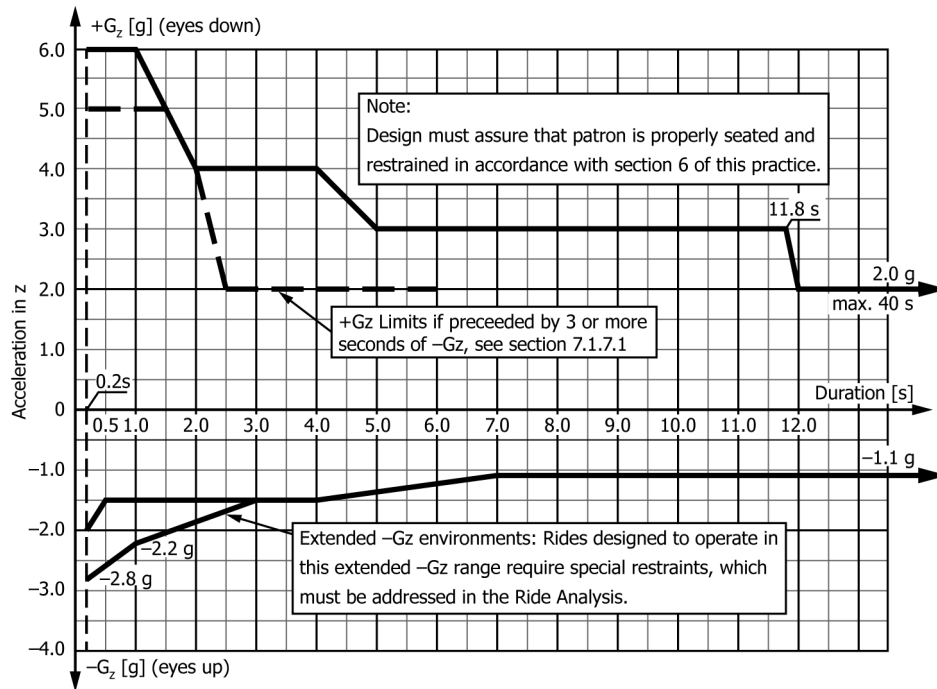

FIG. 8 Acceleration-Duration Limits for Gz (Eyes Down and Eyes Up)

determination, the designer/engineer shall consider biodynamic effects on the patrons. Examples of industry practice are provided in Appendix X8 (non-mandatory).

7.1.4.4 Because of insufficient data, acceleration limits herein do not address patrons with specific physical limitations.

7.1.4.5 The limits specified for all axes are for total net acceleration, inclusive of earth's gravity. A motionless body would therefore have a magnitude of 1 g measured in the axis perpendicular to the earth's surface, and a 0 g magnitude in the axes parallel to the earth's surface.

7.1.4.6 Steady state values in the charts are not limited in time unless otherwise specified. Sustained exposure in excess of 90 s has not been addressed by this practice.

7.1.4.7 These limits are provided for the following basic restraints types:

(1) *Base Case (Class-4 or -5 Restraint)*—For the purpose of acceleration limits the Class-4 restraint used as the base case herein also provides support to the lower body in all directions and maintains patron contact with the patron containment system.

(2) *Upper Torso (Class-4 or -5 Restraint)*

(3) *Prone Restraint*—A prone restraint is one in which the patron is oriented face down at a point or points during the ride cycle. A prone restraint is a restraint designed to allow the patron to accept higher acceleration in the $-G_x$ (eyes front) as compared to the base case and upper torso restraints.

NOTE 2—The type and performance of the restraint system selected has the potential to require a reduction in the acceleration limit.

7.1.4.8 The onset at a specific time shall be determined by finding the slope (acceleration/time) of the best linear fit using the least squares approximation through a 100 millisecond window centered at that specific time. Fig. 9 illustrates how to

calculate onset. See X2.2 for an example of a method for calculating sustained accelerations.

7.1.5 Simultaneous combinations of single axis accelerations shall be limited as follows:

7.1.5.1 The instantaneous combined acceleration magnitude of any two axes shall be limited by a curve that is defined in each quadrant by an ellipse. The ellipse is centered at (0,0) and is characterized by major and minor radii equal to the allowable 200 ms g limits. Graphical representations of this requirement are presented in Figs. 10-17. Combined accelerations that exceed the limits for less than 200 ms in duration shall be excluded.

NOTE 3—For a given amusement ride or device, only three of the curves are applicable.

7.1.6 Reversals in X and Y accelerations are shown in Fig. 18. The following criteria shall apply:

7.1.6.1 The peak-to-peak transition time between consecutive sustained events in X and Y accelerations shall be greater than 200 ms, as measured by the time between the peaks of the consecutive events. When the elapsed time between consecutive sustained events is less than 200 ms, the limit for the peak values shall be reduced by 50 %.

7.1.7 *Transitions in Z:*

7.1.7.1 Transition directly from negative (eyes up) limits to positive (eyes down) limits is restricted. If Patrons are exposed to a negative Gz environment for more than 3 s, then the limits are reduced as shown in the +Gz limit chart for 6 s after the transition to positive Gz. After the 6 s period, it is acceptable to increase the limits to the normal chart levels.

7.1.7.2 Other transitions in Z accelerations are shown in Fig. 19. The following criteria shall apply: When transitioning from sustained weightless (0 g) and more negative levels to 2

Where:
 $G(t)$ = acceleration
 time history

$$t_a = t_o - 50 \text{ msec}$$

$$t_b = t_o + 50 \text{ msec}$$

$$\text{Onset at } t_o = \frac{dG}{dt}$$

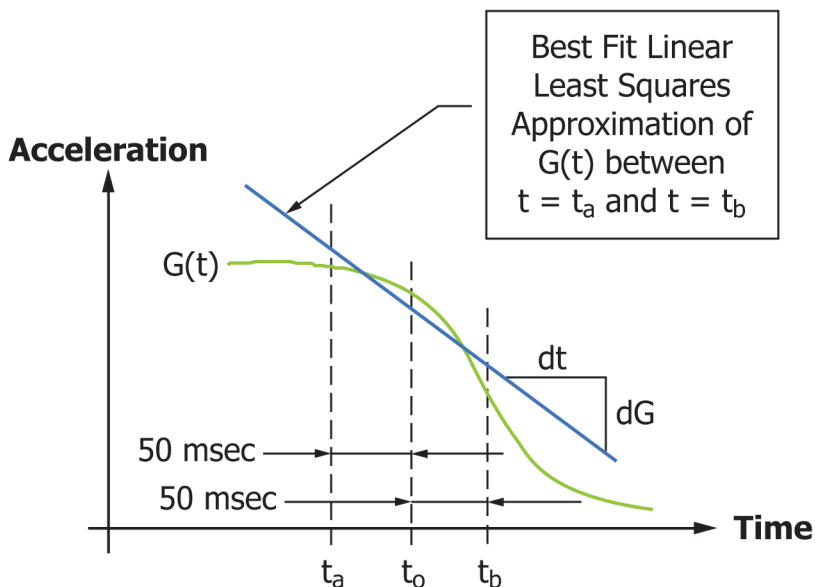

FIG. 9 Onset Calculation

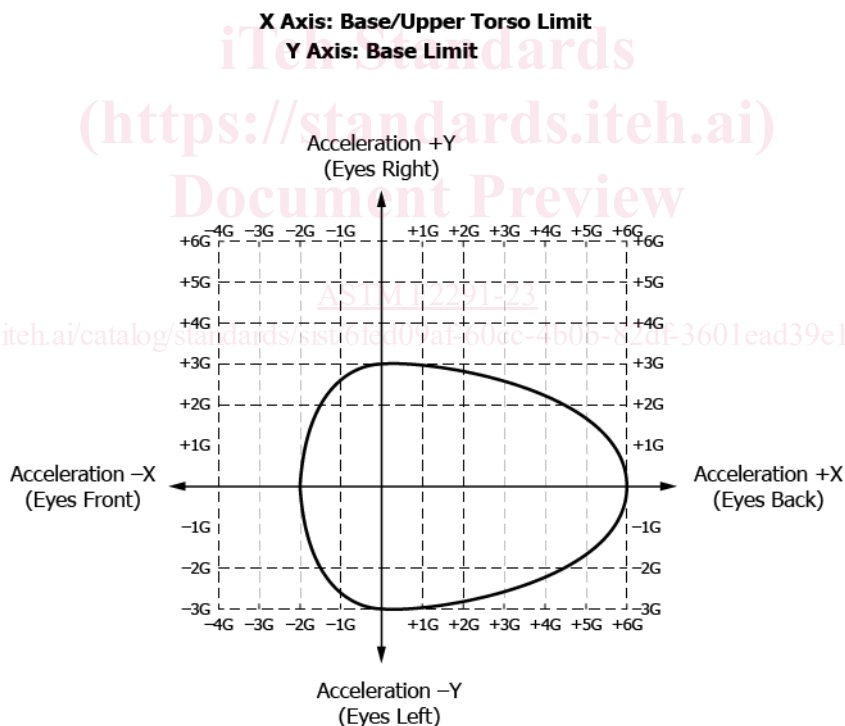

FIG. 10 Allowable Combined Magnitude of X and Y Accelerations

g and more positive levels, duration shall be a minimum of 133 ms. Fig. 20(a) illustrates the decision process for applying the Transitions in Z criteria, and Fig. 20(b) contains examples.

7.1.8 Acceleration related hazards with head-worn accessories (such as helmets, head mounted displays, or bulky costume pieces) shall be considered as part of the Ride Analysis where permitted head-worn accessories have the potential to induce more than a negligible effect on the rider's head inertia. The

analysis shall include, at a minimum, the effect of head-worn accessories on head inertia and ride-related induced head or neck forces, or both.

7.1.8.1 The list below defines common head-worn accessories that have negligible effects on head inertia. These common head-worn accessories do not require additional analysis as specified in 7.1.8.

X Axis: Base/Upper Torso Limit
Z Axis: Base Limit

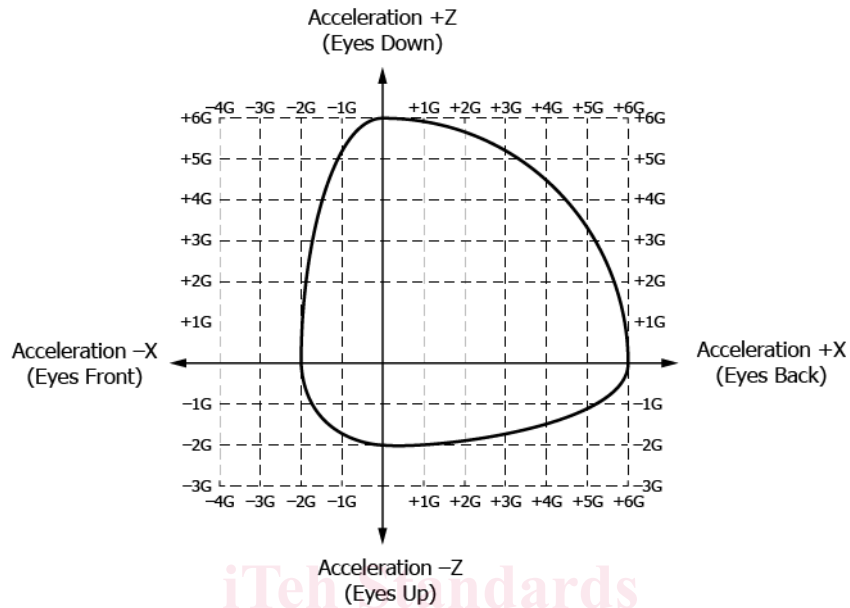

FIG. 11 Allowable Combined Magnitude of X and Z Accelerations

X Axis: Base/Upper Torso Limit
Z Axis: Extended Limit

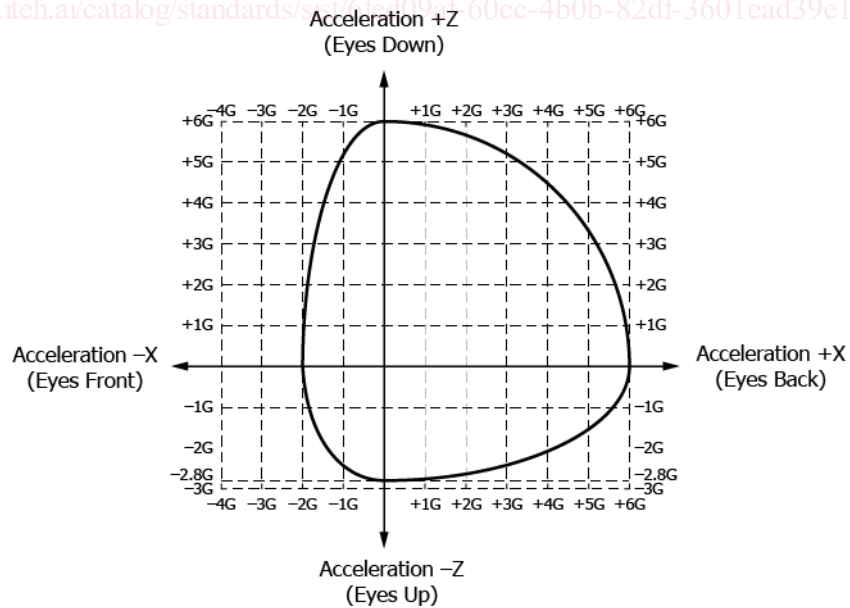

FIG. 12 Allowable Combined Magnitude of X and Z Accelerations

(1) Lightweight and close-fitting glasses (that is, corrective lens wear, sunglasses, protective goggles, or 3D glasses);

(2) Lightweight and close-fitting hats (for example, baseball caps, beanies, berets, ascot caps, etc.);