



Designation: G58 – 85 (Reapproved 2023)

Standard Practice for Preparation of Stress-Corrosion Test Specimens for Weldments¹

This standard is issued under the fixed designation G58; the number immediately following the designation indicates the year of original adoption or, in the case of revision, the year of last revision. A number in parentheses indicates the year of last reapproval. A superscript epsilon (ϵ) indicates an editorial change since the last revision or reapproval.

1. Scope

1.1 This practice covers procedures for the making and utilization of test specimens for the evaluation of weldments in stress-corrosion cracking (SCC) environments.

1.2 Test specimens are described in which (a) stresses are developed by the welding process only, (b) stresses are developed by an externally applied load in addition to the stresses due to welding, and (c) stresses are developed by an externally applied load only with residual welding stresses removed by annealing.

1.3 This practice is concerned only with the welded test specimen and not with the environmental aspects of stress-corrosion testing. Specific practices for the bending and loading of test specimens, as well as the stress considerations involved in preparation of C-rings, U-bend, bent-beam, and tension specimens are discussed in other ASTM standards.

1.4 The actual stress in test specimens removed from weldments is not precisely known because it depends upon the level of residual stress from the welding operation combined with the applied stress. A method for determining the magnitude and direction of residual stress which may be applicable to weldment is described in Test Method E837. The reproducibility of test results is highly dependent on the preparation of the weldment, the type of test specimen tested, and the evaluation criteria used. Sufficient replication should be employed to determine the level of inherent variability in the specific test results that is consistent with the objectives of the test program.

1.5 *This standard does not purport to address all of the safety concerns, if any, associated with its use. It is the responsibility of the user of this standard to establish appropriate safety, health, and environmental practices and determine the applicability of regulatory limitations prior to use.* (For more specific safety hazards information, see Section 7.)

1.6 *This international standard was developed in accordance with internationally recognized principles on standard-*

ization established in the Decision on Principles for the Development of International Standards, Guides and Recommendations issued by the World Trade Organization Technical Barriers to Trade (TBT) Committee.

2. Referenced Documents

2.1 *ASTM Standards:*²

E8 Test Methods for Tension Testing of Metallic Materials [Metric] E0008_E0008M

E399 Test Method for Linear-Elastic Plane-Strain Fracture Toughness of Metallic Materials

E837 Test Method for Determining Residual Stresses by the Hole-Drilling Strain-Gage Method

G1 Practice for Preparing, Cleaning, and Evaluating Corrosion Test Specimens

G30 Practice for Making and Using U-Bend Stress-Corrosion Test Specimens

G35 Practice for Determining the Susceptibility of Stainless Steels and Related Nickel-Chromium-Iron Alloys to Stress-Corrosion Cracking in Polythionic Acids

G36 Practice for Evaluating Stress-Corrosion-Cracking Resistance of Metals and Alloys in a Boiling Magnesium Chloride Solution

G37 Practice for Use of Mattsson's Solution of pH 7.2 to Evaluate the Stress-Corrosion Cracking Susceptibility of Copper-Zinc Alloys

G38 Practice for Making and Using C-Ring Stress-Corrosion Test Specimens

G39 Practice for Preparation and Use of Bent-Beam Stress-Corrosion Test Specimens

G44 Practice for Exposure of Metals and Alloys by Alternate Immersion in Neutral 3.5 % Sodium Chloride Solution

G49 Practice for Preparation and Use of Direct Tension Stress-Corrosion Test Specimens

3. Summary of Practice

3.1 The following summarizes the test objectives that may be evaluated:

¹ This practice is under the jurisdiction of ASTM Committee G01 on Corrosion of Metals and is the direct responsibility of Subcommittee G01.06 on Environmentally Assisted Cracking.

Current edition approved Dec. 1, 2023. Published January 2024. Originally approved in 1985. Last previous edition approved in 2015 as G58 – 85 (2015). DOI: 10.1520/G0058-85R23.

² For referenced ASTM standards, visit the ASTM website, www.astm.org, or contact ASTM Customer Service at service@astm.org. For *Annual Book of ASTM Standards* volume information, refer to the standard's Document Summary page on the ASTM website.

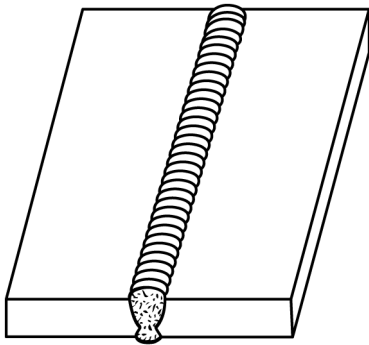

Procedure:

- (a) Specimen size—as required.
- (b) Note grain direction and weld longitudinally or across grain.
- (c) For multiple-pass welds, grind between passes. Use back gouging from opposite side to attain 100 % weld penetration.
- (d) Discard weld ends.
- (e) Remove test sections as required. Sections may be taken across the weld or longitudinally with the weld.

FIG. 1 Flat Weldment

3.1.1 Resistance to SCC of a total weldment (weld, heat-affected zone, and parent metal) as produced by a specific welding process;

3.1.2 Resistance to SCC of deposited weld metal;

3.1.3 Determination of a stress level or stress intensity that will produce SCC in a weldment;

3.1.4 Evaluation of SCC failure in the specific zones of a weld (weld metal, partially melted zone, weld interface, heat-affected zone, and base metal); and

3.1.5 Evaluation of the effect of notches and stress raisers in weldments.

4. Significance and Use

4.1 The intent of this practice is to indicate standard welded specimens and welding procedures for evaluating the SCC characteristics of weldments in corrosive environments. The practice does not recommend the specific corrosive media that may be selected by the user depending upon the intent of his investigation. Specific corrosive media are included in Practices G35, G36, G37, and G44. Other environments can be used as required.

5. Types of Specimens and Specific Applications

5.1 This practice covers the following procedures for the preparation of test weldments. The form of the material to be evaluated (plate, bar, tubing, casting, or forging) may determine whether its usage is applicable in a given test. Residual welding stresses may be left intact or they may be fully or partially removed by an appropriate heat treatment.

5.1.1 *Flat Welding* (Fig. 1)—This weldment (1)³ is applicable for all tension and bend specimens. The size of the weldment may be varied according to the needs of the user or the demands of welding practice being evaluated. It is applicable to any welding procedure and can involve single- or multiple-pass welds.

5.1.2 *Circular Bead Weldment* (Fig. 2)—This weldment (2, 3, 4, 5) measures the tendency for SCC in the base metal, heat-affected zone, and deposited weld metal. The circular weld develops residual stresses. It is applicable to any material form (plate, bar, castings) that can be machined to the

recommended size. The welding procedure involves one circular stringer bead deposit of weld metal.

5.1.3 *Bead-on-Bar Weldment* (Fig. 3)—This weldment (2) measures the tendency for SCC of the base metal. The longitudinal fusion welds develop residual stresses on the bar. It is applicable to materials that can be machined to approximately a 25 mm or 1 in. round.

5.1.4 *Direct Tension Weldments* (Fig. 4)—These weldments (3, 4, 5) measure the cracking tendency in weld metal, base metal, or heat-affected zone. The applied stress is developed in uniaxially loaded tension specimens. Notches may be introduced into the weld metal, base metal, or heat-affected zone. The tension specimens are machined from welded plate or cast sections (Fig. 1) and may be made exclusively from weld metal.

5.1.5 *U-Bend Weldment* (Fig. 5)—This weldment (5, 6) measures crack tendency in the weld, base metal, and heat-affected zone. The bending operation after welding creates high levels of elastic and plastic strain resulting in a wide range of stresses in a single specimen. The presence of residual welding stresses make this a most severe test procedure. It is applicable to any material that can be formed into a U-shape without mechanical cracking or localized bending in the heat-affected zone.

5.1.6 *Bent-Beam Weldment* (Fig. 6)—This weldment (4, 5, 6) measures cracking tendency in the weld bead, the weld base metal interface, and heat-affected zone due to stress concentration. The specimen will contain residual welding stresses and stresses due to elastic strain produced by bending. This specimen is particularly applicable to materials that cannot be bent into a U-shape.

5.1.7 *Precracked Cantilever Beam Weldment* (Fig. 7)—This weldment (5) measures the level of stress intensity to produce crack initiation or propagation in various areas of a weldment. Notches or cracks may be introduced into the weld metal, base metal, or heat-affected zone. The specimen will contain residual welding stresses and applied stresses. Weldments may be prepared in accordance with Fig. 1 or by means of the K-preparation for multiple-pass welds (Fig. 8 and Ref (7)).

5.1.8 *Tuning Fork Weldment* (Fig. 9)—This weldment (5, 9) measures cracking tendency in the base metal, heat-affected zone, or weld-base metal interface if the weld reinforcement is not removed. When the reinforcement is removed, cracking

³ The boldface numbers in parentheses refer to a list of references at the end of this standard.

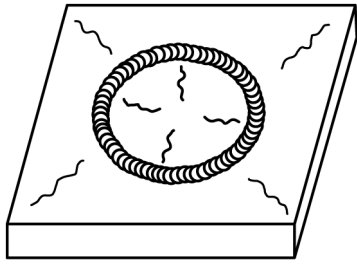

Procedure:

- (a) Specimen size: 100 by 100 by 3 to 12 mm (4 by 4 by 1/8 to 1/2 in.)
- (b) Clamp or tack weld the edges of the test specimen to a base plate to obtain restraint.
- (c) Weld a 50 mm or 2 in. diameter circular bead using the selected weld process (Table 1).
- (d) Examine both sides of specimen after exposure.

FIG. 2 Circular Bead Weldment

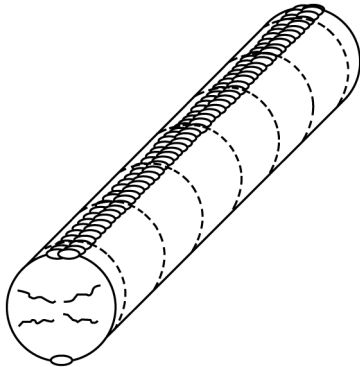

Procedure:

- (a) Specimen size: 25 mm (1 in.) diameter by 150 mm (6 in.) long.
- (b) Fusion weld (GTAW) entire length on opposite sides.
- (c) Discard 6 mm or 1/4 in. from ends and remove 20 mm or 3/4 in. test specimens.
- (d) Examine cross section for radial cracking.

FIG. 3 Bead-on-Bar Weldment

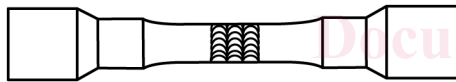

Procedure:

- (a) Direct tension specimens to be machined directly from flat plate weldment (Fig. 1).
- (b) See Practice G49 and Test Methods E8 for recommended dimensions.

FIG. 4 Direct Tension Weldments

may also occur in the weld metal, depending on the susceptibility of the three zones of the weldment and the coincidence of maximum stress with the base metal, heat-affected zone, or weld metal. Stresses are applied by closing the tines of the fork, and the toe of the weld acts as a metallurgical notch. Tuning-fork specimens may also be machined exclusively from weld metal.

5.1.9 *Cruciform Weldment (Fig. 10)*—This weldment (10) will develop the highest degree of weld restraint and residual weld stresses. It has been used for evaluating the susceptibility of high-strength steel and armor plate to underbead cracking in the heat-affected zone of the weld. The welding sequence will produce an increasing degree of restraint with each successive weld pass. The number of passes may be varied. Sections are taken from the weldment and if not already cracked may be exposed to SCC environments.

5.1.10 *C-Ring and Slit Tubing Weldments (Fig. 11)*—These weldments (2, 4, 5) measure the cracking tendency in the weld, base metal, and heat-affected zone. In the C-ring test (Practice G38), the stress is applied externally. In the slit tubing test, the stress is applied by a wedge that is forced into the slit section. While any material form can be machined into a ring section, this test is specifically designed for tubing.

5.1.11 *K-Weld Preparation (Fig. 8)*—This weldment (7) was specifically designed to test the stress-corrosion cracking tendency in various zones of a multiple-pass weld. Notches are made in the weld metal, weld interface, heat-affected zone, or parent metal of cantilever beam-type specimens (Fig. 7). The notches serve as stress concentrators.

NOTE 1—Calculated stresses developed in beam specimens, C-rings, and so forth with weld beads intact will not accurately represent stresses generated in fillets at the edge of the weld beads and in relatively thick

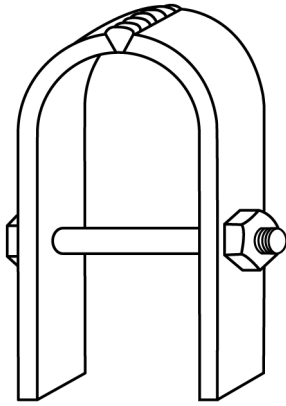

Procedure:
 (a) U-bend specimens to be machined directly from flat plate weldment (Fig. 1)
 (b) See Practice G30 for bending method.

NOTE 1—The welds may be oriented 90° to the direction shown.

FIG. 5 U-Bend Weldment

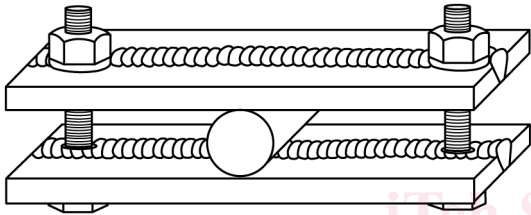

Procedure:
 (a) Bent-beam specimens to be machined directly from flat plate weldment. (Fig. 1). Fulcrum should be notched so as not to contact weld bead.
 (b) Dimensions: as required.
 (c) See Practice G39 for stress calculations.

NOTE 1—The welds may be oriented 90° to the direction shown.

FIG. 6 Bent-Beam Weldment

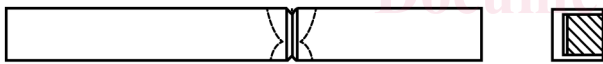

ASTM G58-85(2023)

<https://standards.iteh.ai/catalog/standards/astm/9f4afb17-5275-45ac-ac83-beb1e31cb0c/astm-g58-852023>

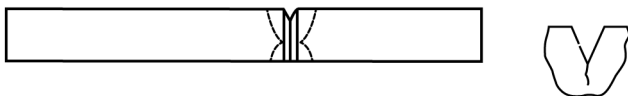

Procedure:
 (a) Specimens may be machined from flat plate weldment (Fig. 1) or K-weld preparation (Fig. 8).
 (b) See Test Method E399 and Ref (8).

FIG. 7 Precracked Cantilever Beam Weldment

beads, and strain gages will be needed if precise values of the applied stress are required. The effective stress of course will be the algebraic sum of the applied stress and residual welding stresses.

NOTE 2—Calculated stresses also may be erroneous for bead-off specimens of weldments of dissimilar alloys or in the case of relatively soft heat-affected zones.

6. Welding Considerations

6.1 The choice of a welding method and the application of proper welding techniques are major factors influencing the overall corrosion resistance of a weldment. Each welding method as described in Refs (11, 12) has its own inherent characteristics which will govern the overall quality of the weld. The welding method must therefore be carefully selected

and monitored since it will be the governing parameter in the procedure and may introduce a number of variables that will affect test results.

6.2 Typical welding methods that are applicable to this practice are listed in Table 1.

6.3 Variables introduced by the welding method are (a) the amount of heat input introduced by the specific welding process and its effect on microstructure of the weld nugget, weld interface, and heat-affected zone of the parent metal, (b) localized variations in chemical composition developed during melting and solidification, (c) the possible pick-up of nitrogen, carbon, silicon, fluorine, or other impurities from surface