



Designation: E2899 – 24

# Standard Test Method for Measurement of Initiation Toughness in Surface Cracks Under Tension and Bending<sup>1</sup>

This standard is issued under the fixed designation E2899; the number immediately following the designation indicates the year of original adoption or, in the case of revision, the year of last revision. A number in parentheses indicates the year of last reappraisal. A superscript epsilon ( $\epsilon$ ) indicates an editorial change since the last revision or reappraisal.

## 1. Scope

1.1 This test method describes the method for testing fatigue-sharpened, semi-elliptically shaped surface cracks in rectangular flat panels subjected to monotonically increasing tension or bending. Tests quantify the crack-tip conditions at initiation of stable crack extension or immediate unstable crack extension.

1.2 This test method applies to the testing of metallic materials not limited by strength, thickness, or toughness. Materials are assumed to be essentially homogeneous and free of residual stress. Tests may be conducted at any appropriate temperature. The effects of environmental factors and sustained or cyclic loads are not addressed in this test method.

1.3 This test method describes all necessary details for the user to test for the initiation of crack extension in surface crack test specimens. Specific requirements and recommendations are provided for test equipment, instrumentation, test specimen design, and test procedures.

1.4 Tests of surface cracked, laboratory-scale specimens as described in this test method may provide a more accurate understanding of full-scale structural performance in the presence of surface cracks. The provided recommendations help to assure test methods and data are applicable to the intended purpose.

1.5 This test method prescribes a consistent methodology for test and analysis of surface cracks for research purposes and to assist in structural assessments. The methods described here utilize a constraint-based framework (**1, 2**)<sup>2</sup> to evaluate the fracture behavior of surface cracks.

NOTE 1—*Constraint-based framework.* In the context of this test method, constraint is used as a descriptor of the three-dimensional stress and strain fields in the near vicinity of the crack tip, where material contractions due to the Poisson effect may be suppressed and therefore

<sup>1</sup> This test method is under the jurisdiction of ASTM Committee E08 on Fatigue and Fracture and is the direct responsibility of Subcommittee E08.07 on Fracture Mechanics.

Current edition approved Feb. 15, 2024. Published April 2024. Originally approved in 2013. Last previous edition approved in 2019 as E2899 – 19<sup>e1</sup>. DOI: 10.1520/E2899-24.

<sup>2</sup> The boldface numbers in parentheses refer to the list of references at the end of this test method.

produce an elevated, tensile stress state (**3, 4**). (See further discussions in Terminology and Significance and Use.) When a parameter describing this stress state, or constraint, is used with the standard measure of crack-tip stress amplitude ( $K$  or  $J$ ), the resulting two-parameter characterization broadens the ability of fracture mechanics to accurately predict the response of a crack under a wider range of loading. The two-parameter methodology produces a more complete description of the crack-tip conditions at the initiation of crack extension. The effects of constraint on measured fracture toughness are material dependent and are governed by the effects of the crack-tip stress-strain state on the micromechanical failure processes specific to the material. Surface crack tests conducted with this test method can help to quantify the material sensitivity to constraint effects and to establish the degree to which the material toughness correlates with a constraint-based fracture characterization.

1.6 This test method provides a quantitative framework to categorize test specimen conditions into one of three regimes: (I) a linear-elastic regime, (II) an elastic-plastic regime, or (III) a field-collapse regime. Based on this categorization, analysis techniques and guidelines are provided to determine an applicable crack-tip parameter for the linear-elastic regime ( $K$  or  $J$ ) or the elastic-plastic regime ( $J$ ), and an associated constraint parameter. Recommendations are provided to assess the test data in the context of a toughness-constraint locus (**2**). For tension loading, a computer program referred to as TASC V1.0.2 (Tool for Analysis of Surface Cracks) may be used to perform the analytical assessments in Section 9, Analysis of Results. The user is directed to other resources for evaluation of the test specimen in the field-collapse regime when extensive plastic deformation in the specimen eliminates the identifiable crack-front fields of fracture mechanics.

NOTE 2—TASC. The computer program TASC is available at no charge either at <https://software.nasa.gov/software/MFS-33082-1> or at <https://sourceforge.net/projects/tascnasa/>. The use of TASC relieves the user of the burden of performing unique elastic-plastic finite element analyses for each test performed in the elastic-plastic regime. For the purposes of this standard, TASC calculations are equivalent to finite element analysis results. Users of TASC should follow the methodologies in Annex A6 for establishing analysis material property inputs. Documentation on the development, verification and validation of TASC is provided in references (**5, 6, 7, 8**).

1.7 The specimen design and test procedures described in this test method may be applied to evaluation of surface cracks in welds; however, the methods described in this test method to analyze test measurements may not be applicable. Weld fracture tests generally have complicating features beyond the scope of data analysis in this test method, including the effects

of residual stress, microstructural variability, and non-uniform strength. These effects will influence test results and must be considered in the interpretation of measured quantities.

1.8 This test method is not intended for testing surface cracks in steel in the cleavage regime. Such tests are outside the scope of this test method. A methodology for evaluation of cleavage fracture toughness in ferritic steels over the ductile-to-brittle region using C(T) and SE(B) specimens can be found in Test Method E1921.

1.9 *Units*—The values stated in SI units are to be regarded as the standard. The values given in parentheses are for information only.

1.10 This practice may involve hazardous materials, operations, and equipment. *This standard does not purport to address all of the safety concerns, if any, associated with its use. It is the responsibility of the user of this standard to establish appropriate safety, health, and environmental practices and determine the applicability of regulatory limitations prior to use.*

1.11 *This international standard was developed in accordance with internationally recognized principles on standardization established in the Decision on Principles for the Development of International Standards, Guides and Recommendations issued by the World Trade Organization Technical Barriers to Trade (TBT) Committee.*

## 2. Referenced Documents

### 2.1 ASTM Standards:<sup>3</sup>

- C1421 Test Methods for Determination of Fracture Toughness of Advanced Ceramics at Ambient Temperature
- E4 Practices for Force Calibration and Verification of Testing Machines
- E6 Terminology Relating to Methods of Mechanical Testing
- E8/E8M Test Methods for Tension Testing of Metallic Materials
- E111 Test Method for Young's Modulus, Tangent Modulus, and Chord Modulus
- E399 Test Method for Linear-Elastic Plane-Strain Fracture Toughness of Metallic Materials
- E647 Test Method for Measurement of Fatigue Crack Growth Rates
- E740 Practice for Fracture Testing with Surface-Crack Tension Specimens
- E1012 Practice for Verification of Testing Frame and Specimen Alignment Under Tensile and Compressive Axial Force Application
- E1820 Test Method for Measurement of Fracture Toughness
- E1823 Terminology Relating to Fatigue and Fracture Testing
- E1921 Test Method for Determination of Reference Temperature,  $T_0$ , for Ferritic Steels in the Transition Range

<sup>3</sup> For referenced ASTM standards, visit the ASTM website, [www.astm.org](http://www.astm.org), or contact ASTM Customer Service at [service@astm.org](mailto:service@astm.org). For *Annual Book of ASTM Standards* volume information, refer to the standard's Document Summary page on the ASTM website.

## 3. Terminology

3.1 For definitions of terms used in this Test Method, Terminologies E6 and E1823 apply.

### 3.2 Symbols:

- 3.2.1 *crack depth, a* [L]—see Terminology E1823 and Fig. 1 in this test method.
  - 3.2.1.1 *Discussion*—In this test method, the term  $a_o$  is the original surface crack depth, as determined in subsection 8.4, used in the evaluation of the test.
- 3.2.2 *crack-mouth opening displacement, CMOD* [L]—see Terminology E1823 and Fig. 1 in this test method.
- 3.2.3 *force, P* [F]—see Terminology E1823.
- 3.2.4 *J-integral, J* [ $FL^{-1}$  or  $FLL^{-2}$ ]—see Terminology E1823.
- 3.2.5 *modulus of elasticity, E* [ $FL^{-2}$ ]—see Terminology E1823.
- 3.2.6 *net section area,  $A_N$*  [ $L^2$ ]—see Terminology E1823. For surface cracks  $A_N = WB - \pi a_o c_o / 2$ .
- 3.2.7 *notch height, h* [L]—the distance between the parallel faces of the machined notch prior to specimen deformation (Fig. 6).
- 3.2.8 *plane-strain fracture toughness,  $K_{Ic}$*  [ $FL^{-3/2}$ ]—see Terminology E1823.

3.2.9 *Poisson's ratio,  $\nu$* —see Terminology E6.

3.2.10 *specimen width, W* [L]—see Terminology E1823 and Fig. 1 from this test method.

3.2.11 *stable crack extension,  $[L]$* —see Terminology E1823.

3.2.12 *stress ratio, R*—see Terminology E1823.

3.2.13 *surface crack length,  $2c$*  [L]—see Terminology E1823 and Fig. 1 in this test method.

3.2.13.1 *Discussion*—In this test method, the term  $2c_o$  is the original surface crack length, as determined in subsection 8.4, used in the evaluation of the test.

3.2.14 *yield strength,  $\sigma_{YS}$*  [ $FL^{-2}$ ]—see Terminology E1823, as determined by 0.2% offset strain method.

### 3.3 Definitions of Terms Specific to This Standard:

3.3.1 *characteristic length,  $r_{\phi a}$ ,  $r_{\phi b}$*  [L]—a physical length measured post-test on the specimen fracture surface and compared to the length scale provided by the deformation limit.  $r_{\phi a}$  is the distance measured on the crack plane normal to the crack front at the parametric angle  $\phi_i$  to the front face (cracked face) of the specimen.  $r_{\phi b}$  is the distance measured on the crack plane normal to the crack front at the parametric angle  $\phi_i$  to the back face (uncracked face) or side of the specimen (Fig. A3.1).

3.3.2 *constraint,  $\Omega$* —in the context of this test method, constraint is a descriptor of the three dimensional stress and strain fields in the near vicinity of the crack tip where material contractions due to the Poisson effect may be suppressed and therefore produce an elevated, three-dimensional tensile (hydrostatic) stress state. An elevated hydrostatic stress state suppresses material yielding and permits larger stresses to

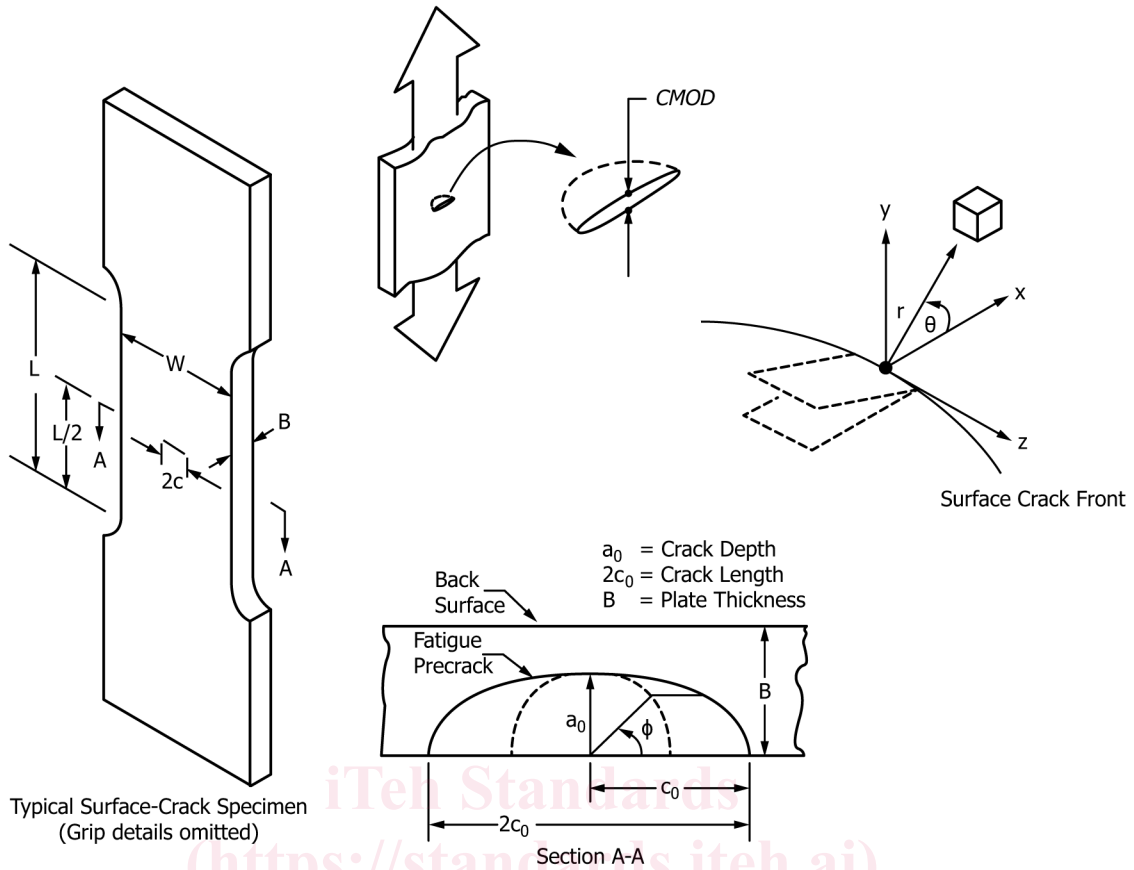

FIG. 1 Test Specimen and Crack Configurations

### Illustrative Example of a Toughness-Constraint Locus

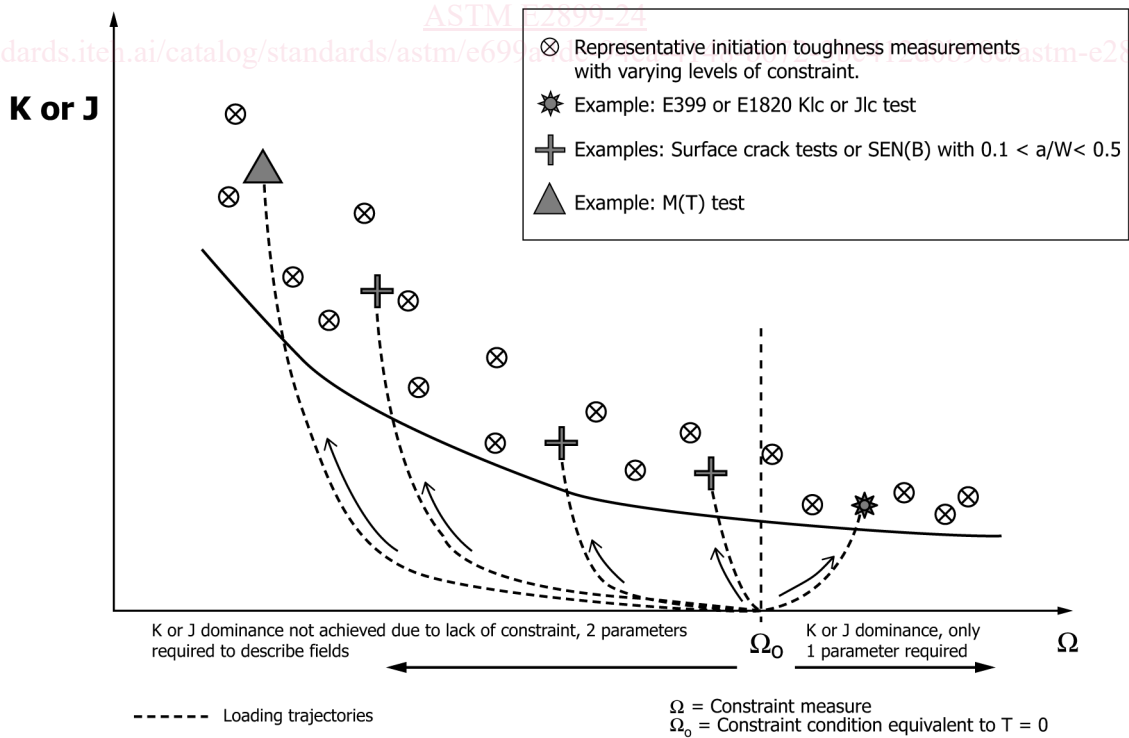

FIG. 2 Toughness-Constraint Locus with Example Trajectories

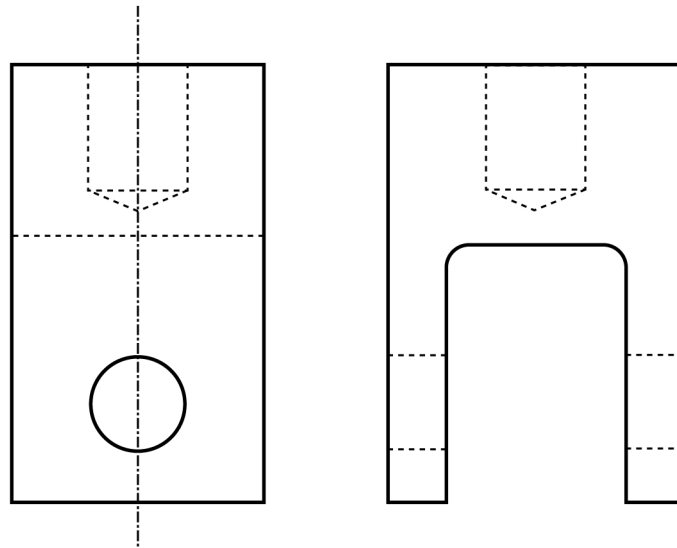

FIG. 3 Recommended Configuration of Tension Testing Clevis

NOTE 1—Flat bottomed holes are not required, but may be used in configurations found in Test Methods E399 or E1820.

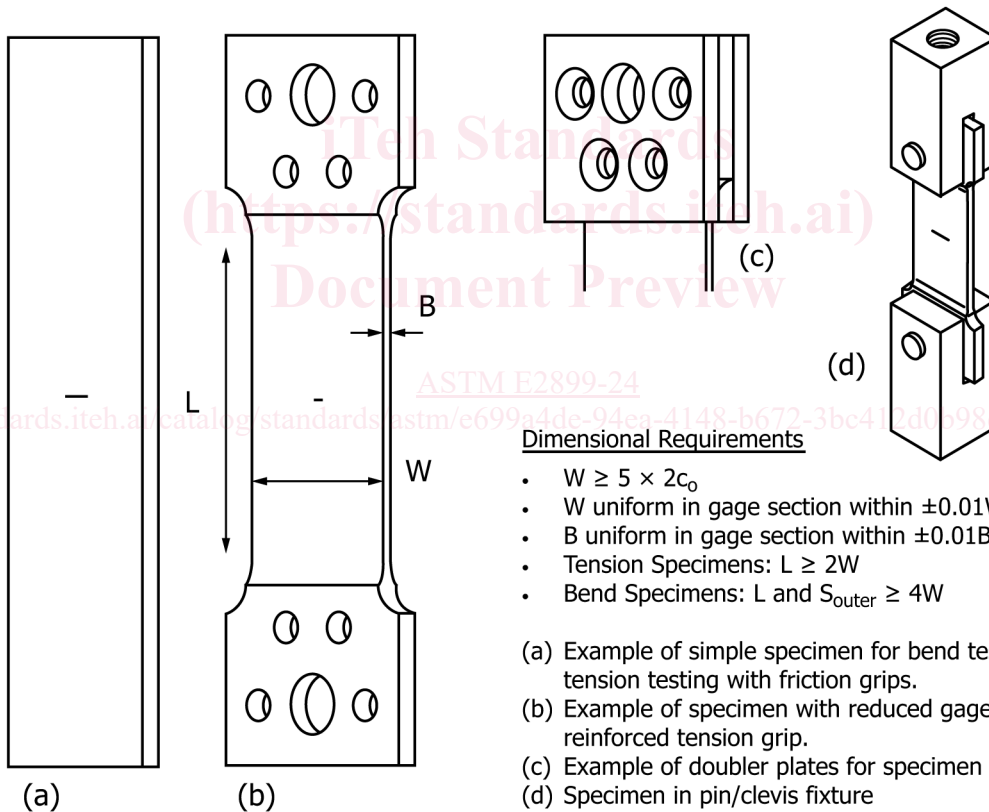

FIG. 4 Specimen Design Principles

develop. The material, geometry, and externally applied loads influence the development of the elevated hydrostatic stress state.

3.3.3 *elastic-plastic regime*—conditions in a test specimen where crack-tip deformations exceed limits of the linear-elastic regime defined in this test method, but  $J$  alone or  $J$  and a constraint term still characterize the crack-tip stress and strain

fields. The non-dimensional parameters,  $C_{Ja}$  and  $C_{Jb}$ , define the deformation limits for validity of the elastic-plastic regime in this test method.

3.3.3.1 *Discussion*—Non-dimensional deformation limits such as  $C_K$ ,  $C_{Ja}$  and  $C_{Jb}$  are commonly designated by the letter “ $M$ ” in the literature (9).

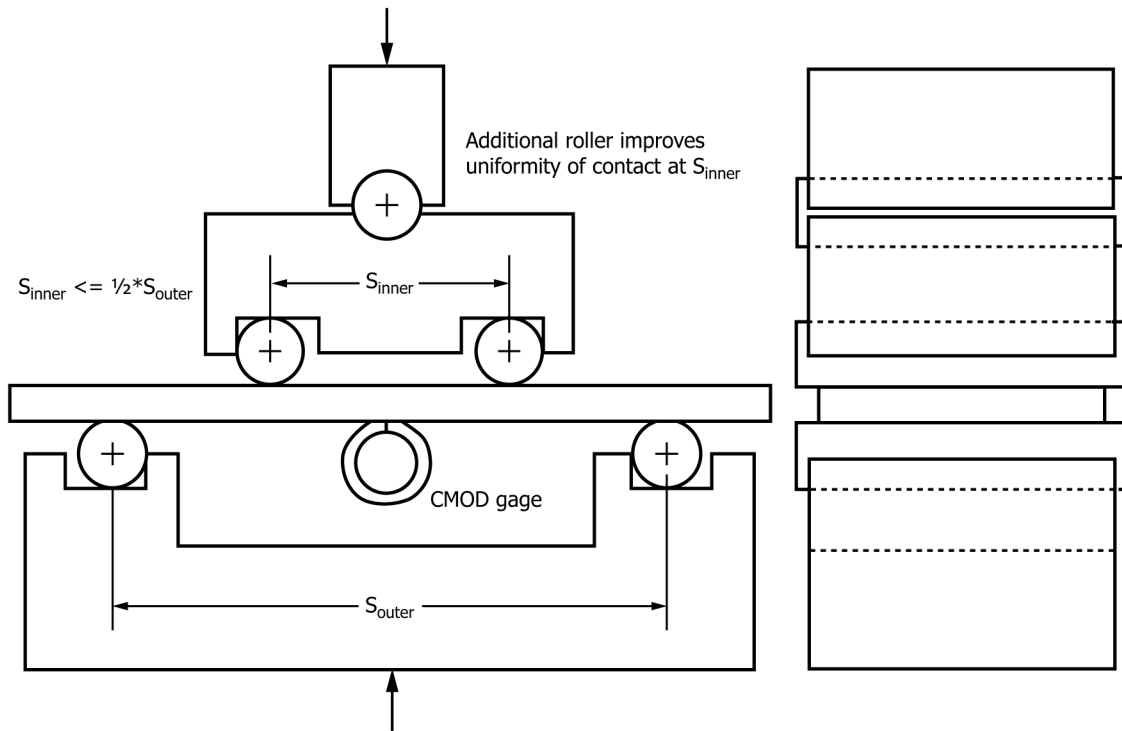

FIG. 5 Recommended Configuration of Bend Testing Apparatus

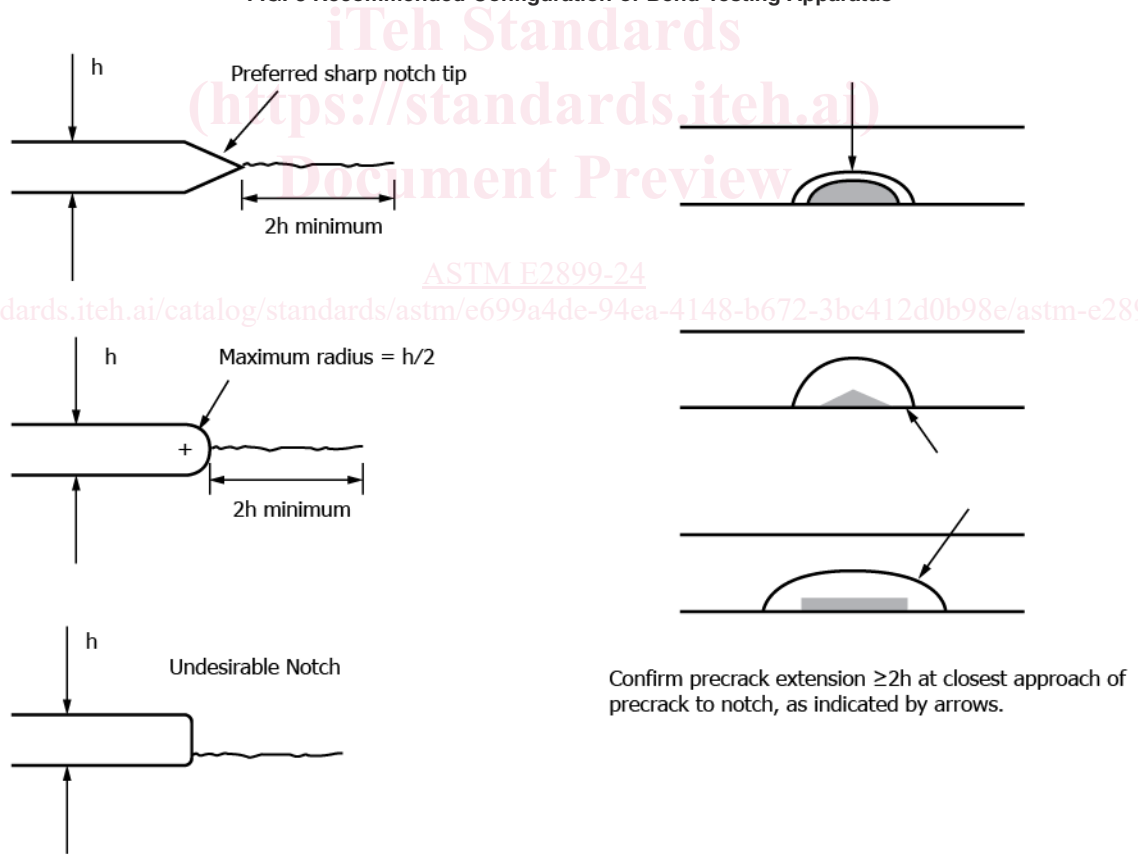

FIG. 6 Fatigue Crack Starter Notch Configuration

3.3.4 *elastic-plastic regime crack size deformation limit*,  $C_{Ja}$ —the non-dimensional, upper limit of deformation for the

elastic-plastic regime based on limiting the crack-tip opening displacement relative to the crack size.



3.3.5 *elastic-plastic regime ligament deformation limit,  $C_{Jb}$* —the non-dimensional, upper limit of deformation for the elastic-plastic regime based on limiting plasticity in the remaining ligament.

3.3.6 *far field stress,  $\sigma [FL^{-2}]$* —stress far removed from the crack plane resulting from applied forces or moments.

3.3.6.1 *Discussion*—For applied tensile forces, the far field stress is the average stress over the gross area, that is  $\sigma = P/WB$ . For applied bending moments, the far field stress is the maximum tensile outer fiber stress across the gross area, that is  $\sigma = 6M/(WB^2)$ .

3.3.7 *field-collapse regime*—conditions in a test specimen where crack-tip deformations exceed the limit of the elastic-plastic regime defined in this test method. Extensive plastic deformation in the specimen eliminates the identifiable crack-front fields of fracture mechanics, which precludes analysis of test conditions in this test method.

3.3.8 *initiation angle,  $\phi_i$* —the parametric angle determined in accordance with [Annex A5](#) that identifies the location along the crack perimeter where the test result is evaluated.

3.3.9 *initiation of surface crack extension*—in the context of this test method, the point during the test when, under monotonically increasing force or moment, the precrack extends a small but consistently measurable amount by stable, ductile tearing, or when the precrack extends in an immediate, unstable ductile mode, failing the specimen.

3.3.9.1 *Discussion*—Parameters associated with the initiation of surface crack extension are designated herein with a subscript  $i$  (for example,  $P_i$ ) and define the state at which the crack front fields are characterized to render the toughness test result. The initiation of surface crack extension will generally be a local occurrence along the perimeter of a surface crack. Due to this localization, defining and experimentally quantifying a universal measure of relative or absolute crack extension for the surface crack geometry is not practical with commonly available laboratory equipment. Therefore, if identifiable, the extent and location of stable crack extension is recorded as an integral part of the test result. See subsection [8.3.4](#). In this context, the surface crack toughness result identifies a point on the material's tearing resistance curve as influenced by the local crack tip constraint conditions. See J-R curve and K-R curve definitions in Terminology [E1823](#).

3.3.10 *initiation crack mouth opening displacement,  $CMOD_i [L]$* —the CMOD at which initiation of surface crack extension occurs.

3.3.11 *initiation force,  $P_i [F]$* —the force at which initiation of surface crack extension occurs.

3.3.12 *initiation moment  $M_i [FL]$* —the applied moment at which initiation of surface crack extension occurs.

3.3.13 *J-dominance*—crack-tip conditions where the elastic-plastic stress and strain fields are quantified by the value of the  $J$ -integral without constraint adjustment.

3.3.13.1 *Discussion*—Crack-tip fields described as  $J$ -dominant in this test method exist when elastic-plastic conditions develop at the crack front and high crack-tip constraint conditions prevail (for example,  $T$ -stress  $\geq 0$ ).

$J$ -dominant fields permit the use of a single parameter characterization of fracture toughness in terms of a critical  $J$ -value. In this test method,  $J$ -dominant conditions prevail to higher levels of crack-tip deformation than do  $K$ -dominant conditions.

3.3.14  $J_K [FL^{-1} \text{ or } FLL^{-2}]$ —a value of the  $J$ -integral calculated from  $K_I$  using the equation:

$$J_K = \frac{K_I^2 (1 - \nu^2)}{E} \quad (1)$$

that is valid for linear-elastic, plane-strain conditions.

3.3.15  $J_p [FL^{-1} \text{ or } FLL^{-2}]$ —the peak value of the  $J$ -integral around the perimeter of the surface crack during monotonic loading.

3.3.16  $J_\phi [FL^{-1} \text{ or } FLL^{-2}]$ —the  $J$ -integral value at the initiation angle ( $\phi_i$ ) when the specimen reaches the initiation crack mouth opening displacement ( $CMOD_i$ ).

3.3.17 *K-dominance*—crack-tip conditions where the stress and strain fields immediately surrounding the crack-tip plastic zone are quantified by the stress intensity factor,  $K_I$ , without constraint adjustment.

3.3.17.1 *Discussion*—Crack-tip fields defined as  $K$ -dominant exist when globally linear-elastic conditions prevail in the specimen (see [3.3.22.1](#)) together with high crack-tip constraint conditions (for example,  $T$ -stress  $\geq 0$ ).  $K$ -dominant fields permit the use of a single parameter fracture criterion expressed as a critical  $K$ -value, and are also  $J$ -dominant by definition.

3.3.18  $K_p [FL^{-3/2}]$ —the peak value of the stress intensity factor around the perimeter of the surface crack during monotonic loading.

3.3.19  $K_\phi [FL^{-3/2}]$ —the stress intensity factor at the initiation angle ( $\phi_i$ ) with applied initiation force ( $P_i$ ), or moment ( $M_i$ ).

3.3.20  $K_{\max-\phi} [FL^{-3/2}]$ —the maximum value of stress intensity occurring around the crack perimeter during fatigue precracking.

3.3.21 *length scale  $[L]$* —a calculated length that is compared to a characteristic length ( $r_{\phi a}$ ,  $r_{\phi b}$ ) of the test specimen to evaluate the test result or determine test validity.

3.3.21.1 *Discussion*—The length scales are defined by a non-dimensional deformation limit,  $C$ , multiplied by the ratio of  $J/\sigma_{YS}$  in the form:

$$\text{length scale} = C \frac{J}{\sigma_{YS}} \quad (2)$$

3.3.22 *linear-elastic regime*—conditions in a test specimen where the stress and strain fields enclosing the crack-tip plastic zone are quantified by  $K_I$  alone, or by  $K_I$  and a constraint term.

3.3.22.1 *Discussion*—The linear-elastic regime applies when the amount of deformation at the crack tip remains small relative to the dimensions of the specimen. Conditions in the linear-elastic regime do not necessarily imply high constraint, for example, the  $T$ -stress may be positive or negative. The limit,  $C_K$ , sets the maximum deformation allowed at the crack tip for the linear-elastic regime in this test method.

3.3.23 *linear-elastic regime deformation limit,  $C_K$* —the non-dimensional, upper limit of deformation for the linear-elastic regime.

3.3.24 *moment,  $M$  [FL]*—the value of the applied moment at the crack plane of a specimen during a test.

$M = (S_{outer} - S_{inner}) P/4$  for four-point bending.

3.3.25 *normalized T-stress,  $T/\sigma$ ,  $T/\sigma_{YS}$* — $T$ -stress divided by far-field stress or yield strength.

3.3.25.1 *Discussion*— $T/\sigma$  is used as a first order measure of constraint, providing a definition and relative comparison of constraint for different crack geometries and loading conditions.

3.3.25.2 *Discussion*— $T/\sigma_{YS}$  is used as a first order, quantifiable measure of constraint to describe crack front stress and strain fields.

3.3.26 *one-parameter fracture*—the use of  $K_I$  or  $J$  alone to describe fracture conditions when the crack-tip fields are  $K$ - or  $J$ -dominant as defined in this test method.

3.3.27 *parametric angle,  $\phi$* —the elliptic angle of position along the crack front, whereby the physical angle is transformed to a position on a semi-circle with radius  $a_o$  (Fig. 1).

3.3.28  $Q$ —a non-dimensional parameter that describes the difference between the crack front stress field of interest relative to a common reference field.

3.3.28.1 *Discussion*— $Q$  can be inferred by subtracting the crack front stress field for the  $T = 0$  reference state from the stress field of interest in the specimen at a chosen normalized radial location in front of the crack tip on the crack plane. A commonly used definition of  $Q$  derives from a plane-strain,  $T = 0$ , reference field such that:

$$Q \equiv \frac{\sigma_{yy} - (\sigma_{yy})_{T=0}}{\sigma_0} \text{ at } \theta = 0 \text{ and } \frac{r\sigma_0}{J} = 2 \quad (3)$$

where  $\sigma_{yy}$  is the stress normal to the crack plane,  $r$  is the radial distance ahead of the crack tip on the crack

plane (see Fig. 1),  $\sigma_0$  is the flow stress (average of the yield and ultimate strength). Alternatively  $\sigma_{YS}$  can be substituted for  $\sigma_0$  in the above equation.

3.3.29  $Q_\phi$ —value of  $Q$  at the initiation angle ( $\phi_i$ ) at deformation level corresponding to  $CMOD_i$ .

3.3.30 *inner span,  $S_{inner}$  L[L]*—distance between inner specimen supports in the four-point bending configuration. See Fig. 5.

3.3.31 *outer span,  $S_{outer}$  L[L]*—distance between outer specimen supports in the four-point bending configuration. See Fig. 5.

3.3.32 *specimen uniform cross section length, L [L]*—length of the center section of the specimen with uniform cross section. See Fig. 1.

3.3.33 *stress intensity factor,  $K, K_p, K_I$  [FL<sup>-3/2</sup>]*—see Terminology E1823. All  $K$ -values in this test method refer to Mode I fracture.

3.3.34 *surface crack extension,  $\ell$  [L]*—an increase in crack length measured normal to original crack front (Fig. 7). Differs from Terminology E1823 due to two-dimensional nature of the crack extension.

3.3.35 *two-parameter fracture*—the use of  $K_I$  or  $J$  together with a constraint term (such as  $T$ -stress or  $Q$ ) to describe fracture conditions when the crack-tip fields are not  $K$ - or  $J$ -dominant.

3.3.36 *T-stress,  $T$  [FL<sup>-2</sup>]*—a linear-elastic parameter used to quantify the first-order effects of constraint on near crack-tip stress and strain fields, and on the measured values of fracture toughness.

3.3.36.1 *Discussion*— $T$ -stress is a scalar value appearing in the second term of the Williams power series expansion of the crack-tip stress fields, where the first two terms are given as:

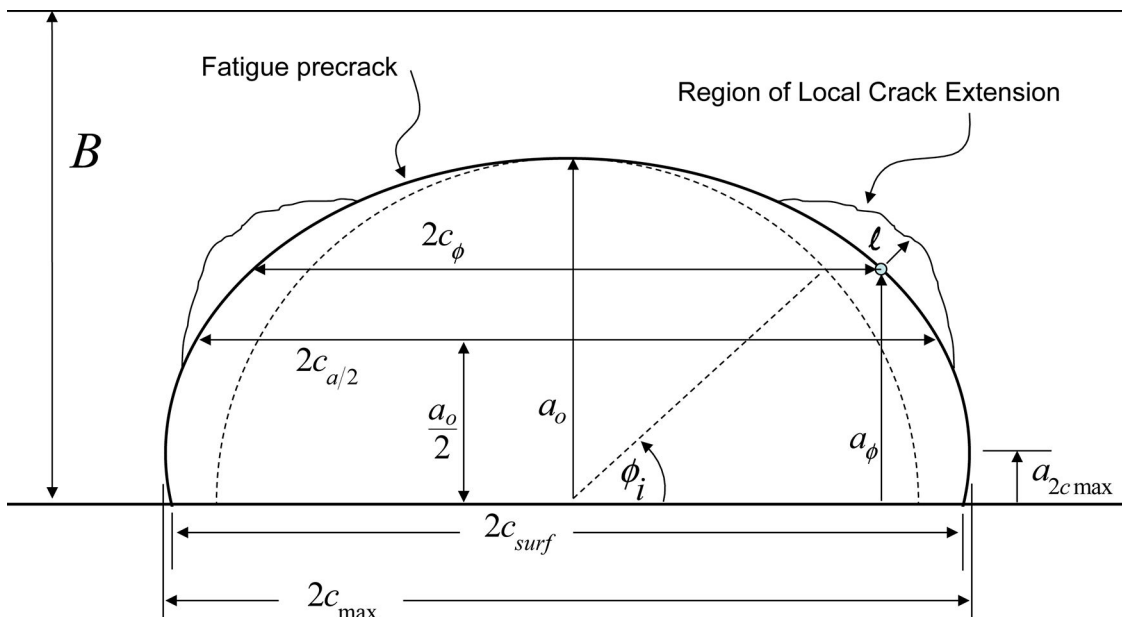

FIG. 7 Required Measurements of Precrack Dimensions and Crack Extension

$$\sigma_{ij}(r, \theta) = \frac{K_I}{\sqrt{2\pi r}} f_{ij}(\theta) + \begin{bmatrix} T & 0 & 0 \\ 0 & 0 & 0 \\ 0 & 0 & \nu T \end{bmatrix} \quad (4)$$

The  $\nu T$  term in  $\sigma_{zz}$  appears only for plane strain conditions. The  $T$ -stress term does not vary with  $r$  and  $\theta$ .

3.3.36.2 *Discussion*—A specimen with geometry and loading combinations that create compressive (negative)  $T$ -stress has low crack front constraint (reduced hydrostatic stress) and, for most ductile fracture processes, may have a higher measured fracture toughness than specimens with a  $T \geq 0$  configuration. A geometry and loading combination that creates tensile (positive)  $T$ -stress has high crack front constraint (increased hydrostatic stress) and may have a slightly decreased measured fracture toughness compared to the  $T \leq 0$  configuration. See [Appendix X4](#) for further discussion.

3.3.36.3 *Discussion*—Some common negative  $T$ -stress configurations include SC(T), M(T), SE(B) with crack size to width ratio ( $a/W$ ) of  $a/W < 0.4$ , and SE(T) with  $a/W < 0.6$ . Some common positive  $T$ -stress configurations include SC(B) with deep cracks, SE(B) with  $a/W > 0.4$ , SE(T) with  $a/W > 0.7$ , C(T), and DC(B).

3.3.37  $T_\phi$  [ $FL^{-2}$ ] $T$ -stress at the initiation angle ( $\phi_i$ ) at deformation level corresponding to  $CMOD_i$ .

3.3.38 *unstable crack extension* [ $L$ ] $T$ -stress at the initiation angle ( $\phi_i$ ) at deformation level corresponding to  $CMOD_i$ .

## 4. Summary of Test Method

4.1 The objective of this test method is to obtain the fracture toughness of fatigue sharpened surface cracks in a constraint-based framework, where the toughness is measured either at the initiation of stable crack extension or immediate instability. The fracture toughness is quantified by either a single toughness value, or by two quantities, a toughness and a measure of constraint.

4.2 The test method consists of notching and fatigue sharpening (see [Section 7](#)) surface cracks into flat rectangular test specimens and then monotonically applying tension or bending force until the initiation of stable tearing is detected or immediate instability fails the specimen. The method requires at a minimum the continuous collection of force during the test. The continuous collection of  $CMOD$  is recommended for all tests, and is required when the limit of the linear-elastic regime is exceeded.

4.3 The method of detecting the onset of stable crack extension is not mandated by this test method; however, suggested methods are provided including electric potential drop, crack mouth opening displacement, acoustic emission, and replicate samples. Other methods are acceptable if validated as part of the test procedure.

4.4 The approach used to analyze the test results includes determining the location around the surface crack front where the initiation of crack extension occurred ( $\phi_i$ ). See [Annex A5](#). Analysis of the test record then compares crack-front conditions and material properties against specific geometric length scales of the specimen to determine which regime appropri-

ately describes the test conditions: linear-elastic regime, elastic-plastic regime, or the field-collapse regime.

4.5 If the test conditions do not lead to the field-collapse regime, the test result is classified into either the linear-elastic or the elastic-plastic regime. For tests demonstrating stable crack extension, the local length of surface crack extension is reported. If a one-parameter description of the crack tip fields is appropriate ( $T_\phi \geq 0$ ) the result includes only  $K_\phi$  or  $J_\phi$ ; otherwise, the result includes  $K_\phi$  or  $J_\phi$  along with the value of  $T_\phi/\sigma_{YS}$  to complete a two-parameter description of the test.

## 5. Significance and Use

5.1 Surface cracks are among the most common defects found in structural components. An accurate characterization and understanding of crack-front behavior is necessary to ensure successful operation of a structure containing surface cracks. The testing of laboratory specimens with surface cracks provides a means to understand and quantify surface crack behavior, but the test results must be interpreted correctly to ensure transferability between the laboratory specimen and the structure.

5.2 Transferability refers to the capacity of a fracture mechanics methodology to correlate the crack-tip stress and strain fields of different cracked bodies. Traditionally, the correlation has been based on the presence at fracture of a dominant, asymptotically singular, crack-tip field with amplitude set by the value of a single parameter, such as the stress intensity factor,  $K_I$ , or the  $J$ -integral. For components and specimens with high crack-tip constraint, the singular crack-tip field dominates over microstructurally significant size scales for loads ranging from globally linear-elastic conditions to moderately large-scale plasticity. For specimens with low crack-tip constraint, a dominant single-parameter crack-tip field exists only at low levels of plasticity. At higher levels of plasticity, the opening mode stress of the low constraint specimen is lower than predicted by the single-parameter, asymptotically singular fields. Therefore, low constraint specimens often exhibit larger fracture toughness than do high constraint specimens. If feasible, users are strongly encouraged to generate high constraint fracture toughness data using methods such as [Test Methods E399](#) or [E1820](#) prior to testing the surface crack geometry.

5.2.1 To address this phenomenon, two-parameter fracture criteria are used to include the influence of crack-tip constraint. Crack-tip constraint has been quantified using various scalar parameters including the  $T$ -stress ([10](#), [11](#), [12](#)),  $Q$  ([13](#), [14](#)), stress triaxiality ([15](#), [16](#)), and  $\alpha_h$  ([17](#), [18](#)). Fracture toughness in a two-parameter methodology is not a single value, but rather is a curve that defines a critical locus of fracture toughness and constraint values ([2](#)). [Fig. 2](#) illustrates a toughness-constraint locus for application of two-parameter fracture mechanics to structures. A structural analysis provides the driving force curve for the configuration of interest, and is plotted with the toughness-constraint locus obtained from specimen test data. Crack extension is predicted when the driving force curve passes through the toughness-constraint locus.

5.3 Tests conducted with this method provide data to assist in the prediction of structural capability in the presence of a



surface crack by including a measure of crack-tip constraint in the interpretation of fracture toughness values. This improves the correlation of test specimen and structural conditions. To achieve the most accurate comparison, the conditions tested in accordance with this test method should match the structure as closely as possible. For conservative structural assessment, the user should ensure that conditions in the test specimen produce higher levels of constraint relative to the structure in application of the data. Factors that influence test specimen conditions include, but are not limited to, specimen geometry,  $a/c$ ,  $a/B$ , loading conditions, as well as the amount and type of crack extension that occurred during the test.

**NOTE 3**—The use of a constraint-based framework for the analysis of surface cracks permits a more realistic assessment of structural capability. This approach generally leads to a less conservative assessment than would be achieved, for example, by using a measure of high-constraint fracture toughness obtained from testing standard C(T) and SE(B) specimens of the material following Test Method E1820. It is essential that constraint effects measured in surface crack tests with this method be applied to any structural assessment with the requisite understanding to maintain appropriate levels of conservatism.

5.4 This test method does not address environmental effects or loading rate effects that may be significant in assessing service integrity.

## 6. Apparatus

6.1 Proper apparatus is required to meet the following minimum requirements: suitable test machine with proper measurement of applied force, instrumentation to record specimen displacements, and tension or bending clevises with associated fixturing. Additional apparatus may be useful to enhance the detection of surface crack extension. See subsection 6.4. The force and displacement measurements along with any supplemental instrumentation must be synchronized and fully recorded throughout the test, either digitally for processing by computer or autographically with an x-y plotter. The apparatus should be configured as mechanically stiff as possible to reduce stored elastic energy during the test. This significantly improves the ability to detect the initiation of stable crack extension.

6.2 *Force Measurement*—Testing machines shall have a force measurement capability conforming to the requirements of Practices E4. Applied force may be measured by any force transducer capable of being recorded continuously. Accuracy of force measurements shall be within 1% of the working range.

6.3 *Displacement Measurement*—A mechanical displacement gauge or other methods (for example digital image correlation) is used to measure the CMOD during the test to establish a force versus CMOD record. The CMOD measurement will aid in identifying the onset of stable tearing and enable verification of test assessment. CMOD measurement is required for all tests except those satisfying subsection 9.2.1, Linear-Elastic Regime Assessment, for which CMOD measurement and analytical confirmation are recommended, but not required.

6.3.1 All displacement gauges shall have a calibrated range no more than twice the maximum expected displacement during the test. The gauge accuracy shall be demonstrated to be

within 1% of the full working range. Each gauge shall be verified for linearity using an extensometer calibrator or other suitable device. The resolution of the calibrator at each displacement interval shall be within 0.00051 mm (0.000020 in.). Readings shall be taken at ten equally spaced intervals over the working range of the gauge. The verification procedure shall be performed three times, removing and reinstalling the gauge in the calibration fixture after each run. The required linearity shall correspond to a maximum deviation of 0.003 mm (0.0001 in.) of the individual displacement readings from a least-squares-best-fit straight line through the data.

6.4 *Crack Extension Instrumentation*—This test method does not dictate the method(s) used to detect surface crack extension. Common methods include using the CMOD measurement, electric potential drop, or acoustic emission. Instrumentation shall be sufficiently calibrated to produce a consistent indication of surface crack extension and shall be recorded as stated in subsection 6.1 for archival use in evaluating the test results.

6.5 *System Verification*—It is recommended that the performance of the force and displacement measuring systems be verified before beginning a series of continuous tests. Calibration accuracy of displacement transducers shall be verified with due consideration for the temperature and environment of the test. Force calibrations shall be conducted periodically and documented in accordance with the latest revision of Practices E4.

### 6.6 Fixtures:

6.6.1 *Tension Fixtures*—The design of tension fixtures shall produce a uniform tension stress across the width and thickness of the specimen gauge section. Friction grips or pin and clevis arrangements are acceptable. Careful attention must be given to specimen and test machine alignment in either case. It is recommended, particularly with new specimen or clevis designs, that the uniformity of the tension stress be verified using a specimen instrumented with opposing strain gauges on an unnotched specimen. The uniformity of strain across all gauges should be confirmed as described in subsection 8.2.5.1. The clevis portion of a pinned specimen design is typical of those found in other fracture test standards. A common configuration is shown in Fig. 3. The flat bottomed holes required for clevises in other standards are not required for this method because specimen rotation is not a concern; clevis holes may be round. The clevis, pins and other fixturing must be fabricated from materials with sufficient strength to prevent yielding, brinelling, or excessive elastic deflection up to the maximum force encountered during test. Fixtures should be fabricated to high quality standards.

**NOTE 4**—Forces may be very high when testing tension specimens. Clevis designs must accommodate the stress and specimens using the pin and clevis design will often require reinforcement at the pin hole to prevent bearing yield or failure. This reinforcement can come from reducing the width, thickness, or both of the test section relative to the grip section or by adding supplemental doubler plates. See example specimen designs in Fig. 4.

6.6.2 *Bending Fixtures*—Fig. 5 shows the general proportions of acceptable four-point bend fixtures. The fixture design minimizes frictional effects by allowing the support rollers to

rotate and move slightly apart as the force on the specimen increases, thus permitting rolling contact. The outer support rollers are allowed limited motion along plane surfaces parallel to the specimen, but are initially held against the inner stops with low tension springs (such as rubber bands).

## 7. Specimen Size, Configuration, and Preparation

**7.1 Principles of Test Specimen Design**—Basic features of surface crack specimen design are shown in Fig. 4. As discussed in Section 5, the intent of surface crack testing is commonly motivated by understanding the effects of surface cracks in structurally relevant configurations. In these situations, it is important that the test specimen represent the structure, primarily in thickness, crack size, and material condition. If the surface crack tests are not relevant to a specific structure, but are intended to characterize the general response of the material to surface defects, the specimen dimensions should be established using the expected toughness and the length scales provided in subsections 9.2.1 (Linear-Elastic Regime Assessment) and 9.2.2 (Elastic-Plastic Regime Assessment), depending on which of these regimes is relevant to the designed test conditions. For general characterization, the crack configurations are recommended to span the range of  $0.2 \leq a/B \leq 0.8$  and  $0.1 \leq a/c \leq 1.0$ . For practical purposes, the minimum crack dimensions permitted are:  $a \geq 1.0$  mm and  $c \geq 1.0$  mm (0.04 in.).

**7.2 Specimen Quantities**—The needed quantity of test specimens depends on the required reliability of the data. If the test results are to be used for design and evaluation of critical structures, sufficient tests to understand the variability of surface crack performance are strongly recommended. For general characterization, a minimum of three tests of a given specimen configuration is recommended. If multiple crack configurations are to be included in the test program, then replicates of each specimen are recommended.

**7.3 Tension Specimen Configuration**—Tensile test specimen proportions are shown in Fig. 4. The controlling proportions are  $W \geq 5 \times 2c$  and  $L \geq 2W$ .

**7.4 Bending Specimen Configuration**—Bend test specimen proportions are shown in Fig. 4. The controlling proportions are  $W \geq 5 \times 2c$  and  $S_{outer}/W \geq 4$ , where Fig. 5 defines the dimension  $S_{outer}$ .

**7.5 Specimen Precracking**—All specimens shall be precracked in fatigue. Experience has shown that it is impractical to obtain a reproducibly sharp, narrow machined notch that will simulate a natural crack well enough to provide a satisfactory fracture toughness test result. The most effective artifice for this purpose is a narrow notch from which extends a comparatively short fatigue crack, called the precrack. (A fatigue precrack is produced by cyclically loading the notched specimen for a number of cycles usually between about  $10^4$  and  $10^6$  depending on specimen size, notch preparation, and stress intensity level.) The dimensions of the notch and precrack, and the sharpness of the precrack shall meet specified conditions that can be readily met with most engineering materials.

**7.5.1 Surface Crack Precracking Objectives**—The precracking procedure must produce a fatigue crack of the intended

length and depth with a regular semi-elliptical shape. The method of producing the starter notch and precrack should not influence the resulting fracture behavior of the test specimen. Fatigue loading may be applied through bending, tension, or a combination of both. The method of applying precrack forces may, and likely will, vary from that used for the actual monotonic test for surface crack extension. Precise control of the stress distribution across the specimen thickness during fatigue cycling is necessary to ensure the surface crack develops in the desired shape.

**7.5.2 Fatigue Crack Starter Notch**—Many different precrack starter notches are possible as shown in Fig. 6. The semi-elliptical starter notch is recommended to maximize the likelihood of producing a fatigue crack of proper shape with a minimum of fatigue crack growth, but other shapes may offer advantages or simplify to the notch machining. The starter notch may be cut by any available means. The plunge electrical discharge machining (EDM) method is the most common, but conventional machining techniques and laser cutting have been used effectively. The height of the notch,  $h$ , should be minimized. In practice, it should not exceed 1.0 mm (0.04 in.). As shown in Fig. 6, it is recommended that the notch end with a sharp “V” shape, and as a minimum the notch should end with a radius  $\leq h/2$ . Generally, the effort to develop a technique for producing sharp notches is a good investment, because the time required to start the precrack is greatly reduced.

**7.5.3 Fatigue Precrack Shape and Length**—The fatigue precrack must be fully established around the full perimeter of the semi-ellipse. At all locations around the perimeter, the fatigue precrack shall extend a minimum  $2h$  from the notch. The final shape shall be a semi-ellipse within the tolerance allowed in subsection 8.4. If additional features are machined into the starter notch for purposes of mechanical CMOD measurement, the precrack shall be sufficiently long to extend to or beyond a 60-degree envelope enclosing the starter notch and any features machined at the surface. See Fig. X3.1 for an illustration.

**7.5.4 Fatigue Precrack Procedures**—The following requirements shall be followed when producing the fatigue precrack.

**7.5.4.1 Fixtures**—The development of a regular semi-elliptical precrack is dependent on uniform stress distribution (tension or bending) over the specimen cross-section. Test fixtures and specimen alignment should be carefully addressed. The quality and precision of all precracking fixtures should be equivalent to those used for testing.

**7.5.4.2 Material Condition**—Fatigue precracking shall be performed with the material in the final heat-treated, mechanically worked, or environmentally conditioned state. Intermediate treatments between fatigue precracking and testing are acceptable only when such treatments are necessary to simulate the conditions of a specific structural application; such departure from recommended practice shall be explicitly reported.

**7.5.4.3 Fatigue Precrack Loading Requirements**—The maximum force applied to the specimen during precracking, including tension, bending, or combined tension/bending, shall limit the stress intensity to the lesser of  $K_{max\phi} < 0.6K_{est}$  or  $30\text{MPa}\sqrt{m}$  ( $27\text{ksi}\sqrt{in}$ ) for the first 50% of the precrack and

the lesser of  $K_{max-\phi} < 0.5K_{est}$  or  $25MPa\sqrt{m}$  ( $22.8ksi\sqrt{in}$ ) for the final 50% of the precrack, where  $K_{est}$  is a provisional estimated material toughness and  $K_{max-\phi}$  is the maximum value of stress intensity occurring around the crack perimeter as calculated by equations in [Appendix X1](#). Precracking should be conducted at as low a  $K_{max-\phi}$  as practical.  $K_{max-\phi}$  is based on the instantaneous precrack size; therefore, forces required to achieve  $K_{max-\phi}$  should be evaluated as the precrack grows. Small starting notches may result in high stresses to achieve the initial  $K_{max-\phi}$  values allowed above. At no time during precracking shall the far field stress exceed 80% of the  $\sigma_{YS}$  (0.2% offset).

(1) Precracking forces are evaluated following the test by using  $K_{\phi}$  in place of the provisional estimated toughness,  $K_{est}$ . To develop precracking parameters,  $K_{est}$  for the material may be estimated from the  $K_{\phi}$  of previous surface crack tests or from linear-elastic plane strain fracture toughness values determined by Test Method [E399](#) or [E1820](#). If no existing material toughness information is available, an acceptable limiting value of  $K_{max-\phi}$  can often be estimated by ensuring  $K_{max-\phi}/E < 0.00016\sqrt{m}$  ( $0.001\sqrt{in}$ ), though not to exceed the values in subsection [7.5.4.3](#). This relationship may not sufficiently limit precracking conditions for high elastic modulus, low toughness materials such as very high strength steels.

(2) The stress ratio, R, during precracking is not prescribed, but is most commonly set at  $R = 0.1$ . Precracking may proceed as a single-step, multiple step, or continuous shedding process. If using the higher initial values of  $K_{max-\phi}$  to hasten the initial 50% or less of precrack growth, then at least one additional step is required to complete the remaining 50% of the precrack with  $K_{max-\phi}$  equal to or less than the values shown. Additional steps or automated load shedding may also be used to achieve this effect. An acceptable method for promoting fatigue crack initiation from the notch is to first apply compressive force cycles not exceeding the planned magnitude of the tensile fatigue precrack loads. If compressive forces are applied to tensile specimen designs (as opposed to bending), then buckling of the specimen must be avoided.

**7.5.4.4 Precracking and Test Temperature**—If the precrack and testing temperature are not the same, in addition to considering the potential for differing material toughness at the test temperature, the change in material strength must also be taken into account through the ratio of material yield strengths when estimating precracking stress intensity. Thus, this ratio is introduced into the relations of subsection [7.5.4.3](#) such that the stress intensity is limited to the lesser of

$$K_{max-\phi} < 0.6(\sigma_{YS}^{precrack} / \sigma_{YS}^{test}) K_{est}$$

$$\text{or } 30 \text{ MPa } \sqrt{m} \text{ (} 27_{ksi} \sqrt{in} \text{)}$$

for the first 50% of the precrack and the lesser of

$$K_{max-\phi} < 0.5(\sigma_{YS}^{precrack} / \sigma_{YS}^{test}) K_{est}$$

$$\text{or } 25 \text{ MPa } \sqrt{m} \text{ (} 22.8_{ksi} \sqrt{in} \text{)}$$

for the final 50% of the precrack, where  $\sigma_{YS}^{precrack}$  is the 0.2% offset yield strength of the material at the precracking temperature and  $\sigma_{YS}^{test}$  is the 0.2% offset yield strength of the material at the test temperature. The limiting values

( $30MPa\sqrt{m}$  and  $25MPa\sqrt{m}$ ) remain unchanged. Environmental effects on material during precracking or test, other than temperature, are not within the scope of this test method.

## 8. Procedure

**8.1 Overview and Objectives**—The test procedure uses displacement control to apply monotonically increasing force or moment to a properly precracked test specimen until the crack begins to extend in a stable fashion, or until the specimen breaks due to unstable crack extension without any prior stable crack extension. If the specimen breaks due to unstable fracture without any prior stable crack extension, the initial crack size is measured and the location of the initiation of surface crack extension identified if possible. This information along with the applied force or moment is then used to evaluate the test in accordance with Section [9](#). If unstable fracture does not occur, the force and crack extension instrumentation are monitored continuously to detect the onset of stable crack extension. When stable crack extension is detected, the force or moment on the specimen is removed (or reduced) and a method of marking the current state of surface crack extension is applied to the test specimen. Finally, force or moment is re-applied in a monotonically increasing manner until specimen failure occurs. The initial crack size and crack extension are measured and are used along with the crack initiation force or moment to evaluate the specimen in accordance with Section [9](#).

**8.2 System and Test Preparation**—Prior to testing, all test apparatus shall be reviewed for compliance with the requirements and confirmed to be calibrated and fully functional.

**8.2.1 Pre-Test Measurement**—Record the following pretest specimen measurements to the nearest 0.025 mm [0.001 in.]:  $W$ ,  $B$ ,  $2c_{surf}$  and  $h$  (precrack notch height at the surface). See [Fig. 1](#), [Fig. 6](#) and [Fig. 7](#). The thickness  $B$  shall be an average of three measurements taken at the center and outside edges of the test specimen along the plane of the crack.

**8.2.2 Testing Rate**—All tests shall be conducted in displacement control. The rate of applied force or moment shall be quasi-static. A loading rate that produces stable crack extension or failure in 1 to 4 minutes is recommended, but shall not be less than 20 seconds. Data acquisition rates for electronic force and displacement measurements shall be commensurate to ensure a high fidelity test record. The time to reach the initiation of surface crack extension or failure shall be recorded for each test specimen. All specimens in a test series shall be loaded at the same nominal displacement rate.

**8.2.3 Test Environment**—The environment for conducting tests shall be carefully controlled and recorded as part of the test record.

**8.2.4 Temperature**—The temperature of the specimen shall be stable and uniform throughout the test within  $\pm 3^\circ\text{C}$  ( $\pm 5^\circ\text{F}$ ) and shall be recorded for each test. Temperature measurement capability must be accurate within  $\pm 1^\circ\text{C}$  ( $\pm 2^\circ\text{F}$ ). For other than ambient temperature tests, the specimen temperature shall be continuously monitored at a minimum of two locations within  $W/4$  of the crack. Before testing in a liquid or gaseous medium for purposes of temperature control, the specimen shall be retained in the medium for at least 60 s/mm