International Standard



6405

INTERNATIONAL ORGANIZATION FOR STANDARDIZATION • МЕЖДУНАРОДНАЯ ОРГАНИЗАЦИЯ ПО СТАНДАРТИЗАЦИИ • ORGANISATION INTERNATIONALE DE NORMALISATION

Earth-moving machinery — Symbols — Operator controls and others

Engins de terrassement — Symboles pour les commandes et autres

First edition — 1982-06-01

iTeh STANDARD PREVIEW
(standards.itih.ai)

[ISO 6405:1982](https://standards.itih.ai/catalog/standards/sist/cb10cec6-0e48-41f8-b0e7-37c43e34b308/iso-6405-1982)

<https://standards.itih.ai/catalog/standards/sist/cb10cec6-0e48-41f8-b0e7-37c43e34b308/iso-6405-1982>

UDC 621.878/.879-51 : 003.62

Ref. No. ISO 6405-1982 (E)

Descriptors : earth handling equipment, symbols.

Foreword

ISO (the International Organization for Standardization) is a worldwide federation of national standards institutes (ISO member bodies). The work of developing International Standards is carried out through ISO technical committees. Every member body interested in a subject for which a technical committee has been set up has the right to be represented on that committee. International organizations, governmental and non-governmental, in liaison with ISO, also take part in the work.

Draft International Standards adopted by the technical committees are circulated to the member bodies for approval before their acceptance as International Standards by the ISO Council.

International Standard ISO 6405 was developed by Technical Committee ISO/TC 127, *Earth-moving machinery*, and was circulated to the member bodies in June 1980.

It has been approved by the member bodies of the following countries :

Australia	Egypt, Arab Rep. of	Poland
Austria	Finland	Romania
Belgium	France	South Africa, Rep. of
Brazil	Germany	Sweden
Bulgaria	India	United Kingdom
Chile	Italy	USA
Czechoslovakia	Japan	USSR

The member body of the following country expressed disapproval of the document on technical grounds :

Canada

Earth-moving machinery — Symbols — Operator controls and others

iTeh STANDARD PREVIEW (standards.iteh.ai)

1 Scope and field of application

This International Standard establishes:

- a) symbols for operator controls,
- b) symbols for controls other than operator controls, for use on earth-moving machines.

2 General

2.1 The symbols shall be as given in clauses 4 to 25, except for deviations necessary to reproduce an accurate representation to the operator's line of sight.

2.2 If, in a symbol, an earth-moving machine or parts of the machine are shown in a side view, a machine driving from right to left shall be assumed.

2.3 Symbols on controls shall be of a good contrast with their background (preferably light symbol on dark background).

2.4 The shading (i.e. shown in black) of the elements of a control depicted on a symbol shall be applied only to the parts which move with direct movement of the designated control device.

2.5 Symbols shall be located on or adjacent to the control for the function depicted.











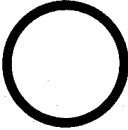
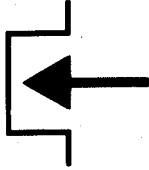
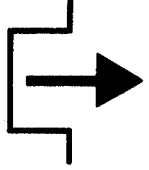

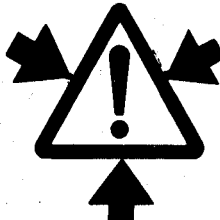

2.6 Where more than one symbol is required (for example on, off, move left, move right), the symbols shall be so located in relation to the control device that movement of the device, in a direction indicated by the relation of the symbols to the control device, shall indicate the sense of the control.

3 Reference



ISO 3461, *Graphic symbols — General principles for presentation*.

DESIGNATION AND ILLUSTRATION OF SYMBOLS









4 General

<p>4.1 On</p> 	<p>4.2 Off (stop)</p> 	<p>4.3 Engage</p> 	<p>4.4 Disengage</p> 
<p>4.5 Increase</p> 	<p>4.6 Decrease</p> 	<p>4.7 Continuous variable (rotational)</p> 	<p>4.8 Move left</p> 
<p>4.9 Move right</p> 	<p>4.10 Caution (Warning)</p> 	<p>4.11 Caution (Warning) : pressurized</p> 	<p>4.12 Caution (Warning) : electric hazard</p> 
<p>4.13 Grease lubrication point</p> 	<p>4.14 Oil lubricant point</p> 	<p>4.15 Hours</p> 	<p>4.16 Lift point</p> 
<p>4.17 Horn</p> 	<p>4.18 Suspension</p> 		





5 Electric

5.1 Battery charging indicator (generator light)	5.2 Voltmeter	5.3 Ammeter	
			

6 Lights





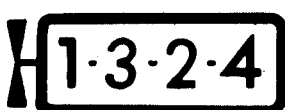
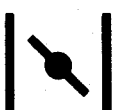



6.1 Upper beam	6.2 Lower beam	6.3 Parking light	6.4 Working light
			
6.5 Spotlight	6.6 Beacon	6.7 Turn signals	6.8 Hazard warning (flasher)
			

7 Engine

7.1 Engine	7.2 Start	7.3 Stop	7.4 Rotational frequency
			
7.5 Emergency stop	7.6 Firing order ³⁾	7.7 Choke	
			

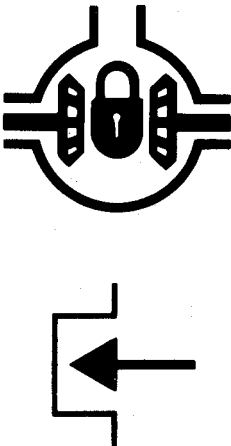



- 1) Framed area of this symbol may be solid.
- 2) It is permissible to separate the left and right arrows.
- 3) Values indicated are only for illustration.

8 Transmission

8.1 Park ¹⁾	8.2 Neutral ¹⁾	8.3 Forward ²⁾	8.4 Reverse ²⁾
			
8.5 Differential lock – engage	8.6 Differential lock – disengage	8.7 Brake	8.8 PTO
			

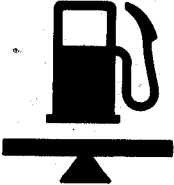



iTeh STANDARD PREVIEW
 (standards.itih.ai)
 ISO 6405:1982
<https://standards.itih.ai/catalog/standards/sist/cb10cecc6-0e48-41f8-b0e7-37c43e34b308/iso-6405-1982>

9 Fuel

9.1 Fill	9.2 Level	9.3 Pressure	9.4 Filter
			
9.5 Shut off			
			

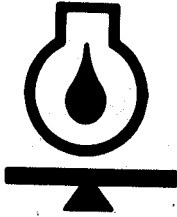



- 1) Symbol for transmission shift pattern.
- 2) Replace block with appropriate machine symbol correctly orientated to arrow.

10 Engine oil



10.1 Fill	10.2 Level	10.3 Pressure	10.4 Temperature
			
10.5 Filter			
			

11 Coolant



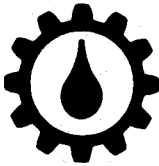
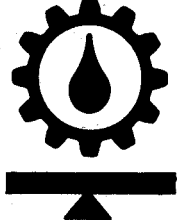
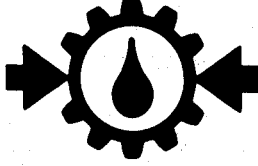

iTeh STANDARD PREVIEW
(standards.iteh.ai)

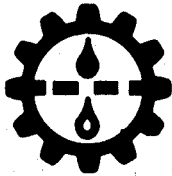
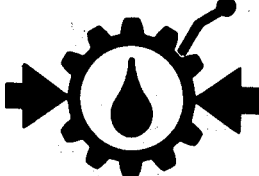
11.1 Fill	11.2 Level	11.3 Pressure	11.4 Temperature
			

12 Drive train oil (including transmission and torque converter)

12.1 Fill	12.2 Level	12.3 Pressure	12.4 Temperature
			
12.5 Filter	12.6 Control-oil pressure		
			

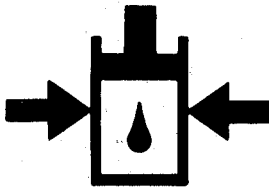

13 Hydraulic oil

13.1 Fill	13.2 Level	13.3 Pressure	13.4 Temperature
			
13.5 Filter			
			





14 Air

iTeh STANDARD PREVIEW

(standards.iteh.ai)

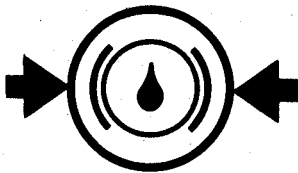

14.1 Fill	14.2 Pressure	14.3 Filter	
			

15 Brake fluid

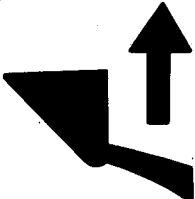
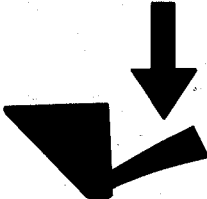
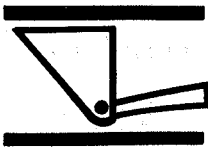

15.1 Fill	15.2 Level	15.3 Pressure	15.4 Temperature
			

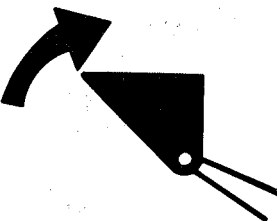
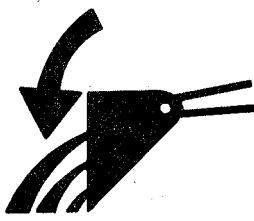
16 Bucket – loader

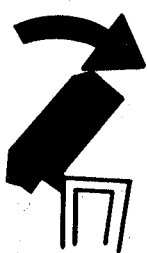

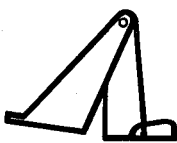

16.1 Bucket	16.2 Raise	16.3 Lower	16.4 Hold
			

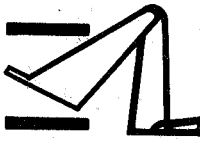
<p>16.5 Float</p> 	<p>16.6 Roll back</p> 	<p>16.7 Dump</p> 	<p>16.8 Side dump – dump</p> 
<p>16.9 Side dump – return</p> 			

17 Bucket multi-purpose¹⁾

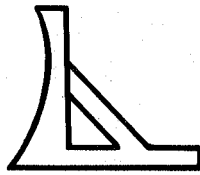
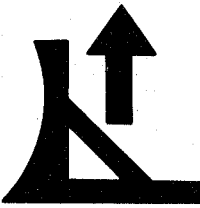
<p>17.1 Bucket</p> 	<p>17.2 Open</p> 	<p>17.3 Close</p> 	<p>17.4 Hold</p> 
--	--	--	--

18 Blade

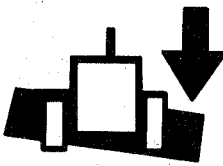
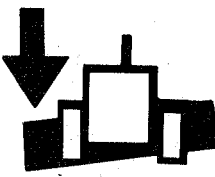
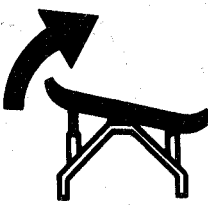
<p>18.1 Blade</p> 	<p>18.2 Raise</p> 	<p>18.3 Lower</p> 	<p>18.4 Hold</p> 
<p>18.5 Float</p> 	<p>18.6 Tilt right</p> 	<p>18.7 Tilt left</p> 	<p>18.8 Angle right</p> 

1) For other symbols, see 16 "Bucket – loader".