



SLOVENSKI STANDARD
SIST ISO 9960-1:1995

01-junij-1995

Risalno orodje z delitvijo ali brez nje - 1. del: Ravnila s skalo

Draughting instruments with or without graduation -- Part 1: Draughting scale rules

Instruments de dessin avec ou sans graduation -- Partie 1: Règles graduées de dessinateurs

(standards.iteh.ai)

Ta slovenski standard je istoveten z: ISO 9960-1:1992

<https://standards.iteh.ai/catalog/standards/sist/0d1ff0a3-1847-4927-aaff-13e2dbfee1f5/sist-iso-9960-1-1995>

ICS:

01.100.40 Risalna oprema Drawing equipment

SIST ISO 9960-1:1995

en

iTeh STANDARD PREVIEW
(standards.iteh.ai)

SIST ISO 9960-1:1995

<https://standards.iteh.ai/catalog/standards/sist/0d1ff0a3-1847-4927-aaff-13e2dbfee1f5/sist-iso-9960-1-1995>

INTERNATIONAL STANDARD

ISO
9960-1

First edition
1992-07-15

Draughting instruments with or without graduation —

Part 1:

Draughting scale rules (standards.iteh.ai)

Instruments de dessin avec ou sans graduation —

Partie 1: Règles graduées de dessinateurs

<https://standards.iteh.ai/catalog/standards/sist/0d110a5-1847-4927-aaff-13e2dbfee1f5/sist-iso-9960-1-1995>



Reference number
ISO 9960-1:1992(E)

ISO 9960-1:1992(E)

Foreword

ISO (the International Organization for Standardization) is a worldwide federation of national standards bodies (ISO member bodies). The work of preparing International Standards is normally carried out through ISO technical committees. Each member body interested in a subject for which a technical committee has been established has the right to be represented on that committee. International organizations, governmental and non-governmental, in liaison with ISO, also take part in the work. ISO collaborates closely with the International Electrotechnical Commission (IEC) on all matters of electrotechnical standardization.

Draft International Standards adopted by the technical committees are circulated to the member bodies for voting. Publication as an International Standard requires approval by at least 75 % of the member bodies casting a vote.

International Standard ISO 9960-1 was prepared by Technical Committee ISO/TC 10, *Technical drawings, product definition and related documentation*, Sub-Committee SC 9, *Media and equipment for drawing and related documentation*.

ISO 9960 consists of the following parts, under the general title *Draughting instruments with or without graduation*:

- Part 1: *Draughting scale rules*
- Part 2: *Protractors*
- Part 3: *Set squares*

Annex A of this part of ISO 9960 is for information only.

© ISO 1992

All rights reserved. No part of this publication may be reproduced or utilized in any form or by any means, electronic or mechanical, including photocopying and microfilm, without permission in writing from the publisher.

International Organization for Standardization
Case Postale 56 • CH-1211 Genève 20 • Switzerland

Printed in Switzerland

Draughting instruments with or without graduation —

Part 1: Draughting scale rules

1 Scope

This part of ISO 9960 specifies the main requirements and the accuracy of draughting scale rules, and their graduations in SI units (International System of Units).

Two types of draughting scale rule are covered, those for hand use and those for manually operated draughting machines, both for professional use only. Scale rules for use in schools are not included.

2 Normative references

The following standards contain provisions which, through reference in this text, constitute provisions of this part of ISO 9960. At the time of publication, the editions indicated were valid. All standards are subject to revision, and parties to agreements based on this part of ISO 9960 are encouraged to investigate the possibility of applying the most recent editions of the standards indicated below. Members of IEC and ISO maintain registers of currently valid International Standards.

ISO 554:1976, *Standard atmospheres for conditioning and/or testing — Specifications*.

ISO 3098-1:1974, *Technical drawings — Lettering — Part 1: Currently used characters*.

ISO 9962-3:—¹⁾, *Manually operated draughting machines — Part 3: Dimensions of scale rule chuck plates*.

1) To be published.

2) Term defined in ISO 10209-1^[5].

3 Definitions

For the purposes of this part of ISO 9960, the following definitions apply.

3.1 graduation: Division lines and figuring. The graduation may be engraved in black.

3.2 major divisions: Lines along the edge of a scale rule defining the major units.

3.3 figuring: Numbering and lettering on a scale rule identifying the values of the major divisions.

3.4 division lines: Lines along the edge of a scale rule, including both the major divisions and the lines subdividing the major divisions.

3.5 (draughting) scale rule: Parallel-sided draughting instrument on which graduations are applied.

Draughting scale rules are used to draw straight lines and/or to measure distances on drawings which can be either full scale, reduced or enlarged with respect to the object to be shown.

3.6 scale: Ratio of the linear dimension of an element of an object as represented in the original drawing²⁾ to the real linear dimension of the same element of the object itself.

NOTE 1 The scale of a print may be different from that of the original drawing (see ISO 5455^[1]).

3.7 nominal length (of the scale rule): Graduated length of the scale rule.

ISO 9960-1:1992(E)

3.8 inspection scale rule: Scale rule used only for testing purposes.

e) two bevel, see figure 5;

4 Characteristics

4.1 Cross-sections

The general shape of the scale rule cross-section may be as follows:

a) flat, see figure 1;

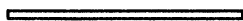

Figure 1

b) four bevel, see figure 2;

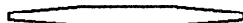

Figure 2

c) oval, see figure 3;

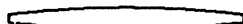

Figure 3

d) semi-oval, see figure 4;



Figure 4

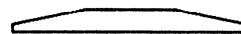

Figure 5

f) one bevel, see figure 6;

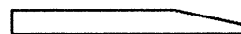

Figure 6

g) opposite bevel, see figure 7;

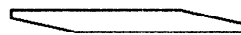

Figure 7

h) triangular, see figure 8;



Figure 8

iTeh STANDARD PREVIEW
(standards.iteh.ai)

SIST ISO 9960-1:1995

<https://standards.iteh.ai/catalog/standards/sist/0d1ff0a3-1847-4927-aaff-13e2dbfee1f5/sist-iso-9960-1-1995>

4.2 Nominal lengths

The nominal lengths are as follows:

150 mm; 200 mm; 250 mm; 300 mm; 350 mm;
400 mm; 450 mm; 500 mm; 600 mm; 800 mm;
1 000 mm.

The nominal length of inspection scale rules shall be 300 mm or 500 mm.

4.3 Lengths of division lines

The lengths of the division lines are as follows:

1,8 mm; 2,5 mm; 3,5 mm; 5 mm; 7 mm; 10 mm.

The length of lines for each level of subdivision shall be constant throughout the scale rule.

4.4 Tolerance on length of division lines

The tolerances on the length of the division lines are as follows:

- lengths of 1,8 mm and 2,5 mm: $\pm 0,3$ mm
- lengths of 3,5 mm and 5 mm: $\pm 0,5$ mm
- lengths of 7 mm and 10 mm: ± 1 mm

4.5 Width of division lines

The mean width of division lines shall range from a minimum of 0,08 mm to a maximum of 0,13 mm for adjacent division lines where the distance between division lines is not more than 0,5 mm, and from a minimum of 0,09 mm to a maximum of 0,18 mm for adjacent division lines where the distance between division lines is more than 0,5 mm. The width of each division line shall not differ by more than 10 % from the mean width. In each scale rule, the same mean width of division lines shall be used, regardless of their length.

4.6 Distance between division lines

The distance between division lines shall be measured between their centres. The space between adjacent division lines shall not be less than four times the mean width of those division lines.

4.7 Smallest subdivision

The smallest subdivision shall be not less than 0,4 mm.

4.8 Graduation intervals

The major divisions and the lines subdividing the major divisions shall be indicated by using three different lengths of division line (see table 1).

4.9 Beginning of graduation

The first division line shall be at a distance of 10 mm or $5n$ millimetres, with $n = 2, 3, \dots$, from the nearest end of the scale rule (see figure 9).

Dimensions in millimetres



Figure 9

4.10 Characters

Vertical characters of type A, in accordance with ISO 3098-1, shall be used.

4.11 Height of digits

The height of digits shall be 1,8 mm or, in accordance with ISO 3098-1, 2,5 mm or 3,5 mm.

4.12 Arrangement of digits

Each digit shall be centred on the corresponding major division.

4.13 Scales for scale rule graduations

The graduations for scales in accordance with ISO 5455[1] are given in table 1.



4.14 Indication of scale

The indication of the scale shall be placed on the left of the zero-point, as shown on figure 9, for example 1:1.

4.15 Overall length

The overall length shall be 20 mm to 30 mm longer than the nominal length, to allow for the necessary indication of the scale.

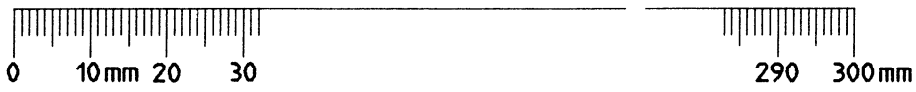
Table 1 — Graduations for scale rules

Scales (see ISO 5455 ⁽¹⁾)	Graduation and measurement unit
1:1	 0 10 mm 20 30 290 300 mm
1:10	0 100 mm 200 300 2 900 3 000 mm
1:100	0 1 m 2 3 29 30 m
1:1 000	0 10 m 20 30 290 300 m
1:10 000	0 100 m 200 300 2 900 3 000 m
10:1	0 1 mm 2 3 29 30 mm
1:2	 0 50 100 mm 150 600 mm
1:20	0 0,5 1 m 6 m
1:200	0 5 10 m 60 m
1:2 000	0 50 100 m 600 m
5:1	0 5 10 mm 60 mm
1:5	 0 100 mm 1 400 1 500 mm
1:50	0 1 m 14 15 m
1:500	0 10 m 140 150 m
1:5 000	0 100 m 1 400 1 500 m
2:1	0 10 mm 140 150 mm

5 Dimensions and geometrical tolerances

5.1 Cross-section dimensions

Cross-section dimensions of scale rules are left to the manufacturer's choice.

The shapes and dimensions of working edges shall be as shown in figure 10 or 11, and given in table 2.

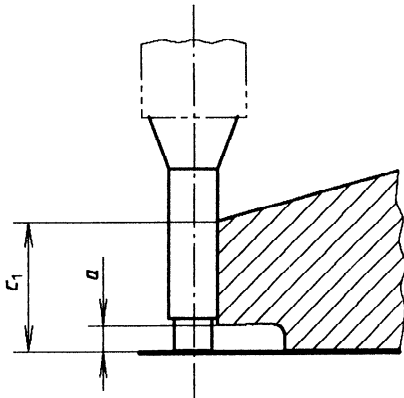

Figure 10

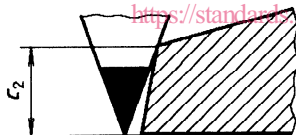









Figure 11

Table 2 — Working edge dimensions of scale rules for various draughting instruments (see figures 10 and 11)

Dimensions in millimetres

Symbol of draughting instrument	Description of draughting instrument	ink recess <i>a</i>	Height of working edge	
			<i>c</i> ₁	<i>c</i> ₂
	Tubular technical pen with stepped tube tip (see ISO 9175-1 ^[2])	0,4 to 0,6	1 to 1,5	—
	Tubular technical pen with tube tip not stepped			
	Fine lead mechanical pencil, tubular guided	0,4 to 0,6	1 to 1,5	0,5 to 1
	Fine lead mechanical pencil, lead guided	—	—	
	Wood-cased pencil, clutch pencil	—	—	
	Felt-tip/fibre-tip pen, tubular guided	0,4 to 0,6	1 to 1,5	—
	Felt-tip/fibre-tip pen, fibre-tip guided	—	—	
	Ball-point pen	0,4 to 0,6	1 to 1,5	0,5 to 1