



Designation: F 977 – 03

Standard Consumer Safety Specification for Infant Walkers¹

This standard is issued under the fixed designation F 977; the number immediately following the designation indicates the year of original adoption or, in the case of revision, the year of last revision. A number in parentheses indicates the year of last reapproval. A superscript epsilon (ϵ) indicates an editorial change since the last revision or reapproval.

INTRODUCTION

This consumer safety specification addresses walker incidents that were identified by the U.S. Consumer Product Safety Commission (CPSC).

Based on data collected by the CPSC, the majority of incidents involved children falling down stairs or steps in walkers. Other incidents involved children tipping over in walkers or accessing hot surfaces or liquids. The injuries associated with these incidents ranged from cuts and bruises to burns, skull fractures, and deaths. Most of the children injured were under 15 months old.

In response to the incident data provided by the CPSC, this consumer safety specification attempts to minimize the risk of injury or death associated with children in walkers falling down stairs or between levels, or tipping over. It also contains provisions to address the risk of injury associated with walker seating systems and folding mechanisms.

1. Scope

1.1 This consumer safety specification covers performance requirements, test methods, and marking requirements to promote safe use of the infant walker (see 3.1).

1.2 This consumer safety specification is intended to minimize accidents to children resulting from normal use and reasonably foreseeable misuse or abuse of walkers.

1.3 No walker produced after the approval date of this consumer safety specification shall, either by label or other means, indicate compliance with this specification unless it conforms to all requirements contained herein.

1.4 This consumer safety specification is not intended to address accidents and injuries resulting from the interaction of other persons with the child in the walker or the accidents resulting from abuse and misuse by children able to walk.

1.5 The values stated in inch-pound units are to be regarded as the standard. The SI units given in parentheses are for information only.

1.6 The following precautionary caveat pertains only to the test method portion, Section 7, of this consumer safety specification: *This standard does not purport to address all of the safety concerns, if any, associated with its use. It is the responsibility of the user of this standard to establish appropriate safety and health practices and determine the applicability of regulatory limitations prior to use.*

appropriate safety and health practices and determine the applicability of regulatory limitations prior to use.

2. Referenced Documents

2.1 ASTM Standards:²

D 3359 Test Methods for Measuring Adhesion by Tape Test

2.2 Federal Regulations:³

16 CFR 1303 Ban of Lead-Containing Paint and Certain Consumer Products Bearing Lead-Containing Paint

16 CFR 1500 Hazardous Substances Act Regulations Including Sections:

1500.18 (a) (6) Banned Toys and Other Banned Articles Intended for Use by Children

1500.48 Technical Requirements for Determining a Sharp Point in Toys or Other Articles Intended for Use by Children Under Eight Years of Age

1500.49 Technical Requirements for Determining a Sharp Metal or Glass Edge in Toys or Other Articles Intended for Use by Children Under Eight Years of Age

1500.50–.52 Test Methods for Simulating Use and Abuse of Toys and Other Articles Intended for Use by Children

1500.86 (a) (4) Exemptions from Classification as a Banned Article for Use by Children

16 CFR 1501 Method for Identifying Toys and Other

¹ This consumer safety performance specification is under the jurisdiction of ASTM Committee F15 on Consumer Products and is the direct responsibility of Subcommittee F15.17 on Carriages, Strollers, Walkers, and Stationary Activity Centers.

Current edition approved March 10, 2003. Published April 2003. Originally approved in 1986. Last previous edition approved in 2000 as F 977 – 00.

² For referenced ASTM standards, visit the ASTM website, www.astm.org, or contact ASTM Customer Service at service@astm.org. For *Annual Book of ASTM Standards* volume information, refer to the standard's Document Summary page on the ASTM website.

³ Available from U.S. Government Printing Office, N. Capital and H Streets, NW, Washington, DC 20401.

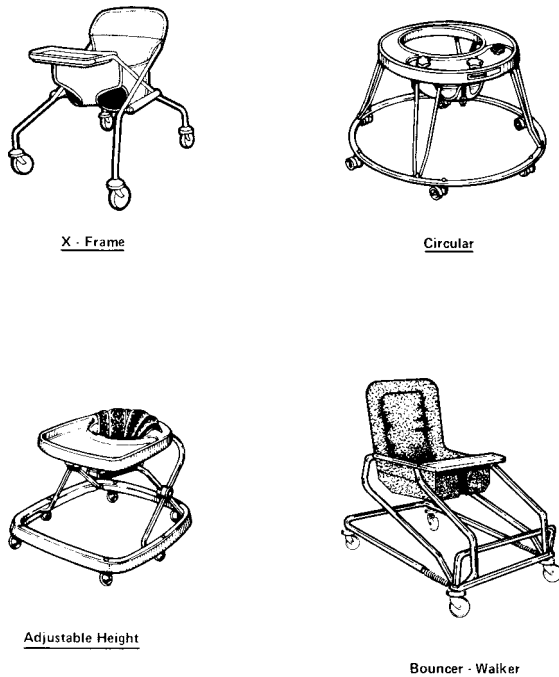

FIG. 1 Illustrations of Four Types of Baby Walkers

Articles Intended for Use by Children Under Three Years of Age Which Present Choking, Aspiration, or Ingestion Hazards Because of Small Parts

3. Terminology

3.1 Definitions of Terms Specific to This Standard:

3.1.1 *conspicuous*—a label that is visible, when the unit is in a manufacturer's recommended use position, to a person standing near the unit at any one position around the unit but not necessarily visible from all positions.

3.1.2 *dynamic load*—application of impulsive force through free fall of a weight.

3.1.3 *manufacturer's recommended use position*—any position that is presented as a normal, allowable, or acceptable configuration for the use of the product by the manufacturer in any descriptive or instructional literature. This specifically excludes positions that the manufacturer shows in a like manner in its literature to be unacceptable, unsafe, or not recommended.

3.1.4 *non-paper label, n*—any label material (such as plastic or metal) which either will not tear without the aid of tools or tears leaving a sharply defined edge.

3.1.5 *occupant*—that individual who is in a product that is set up in one of the manufacturer's recommended use positions.

3.1.6 *paper label, n*—any label material which tears without the aid of tools and leaves a fibrous edge.

3.1.7 *static load*—a vertically downward force applied by a calibrated force gage or by dead weights.

3.1.8 *walker*—a mobile unit that enables a child to move on a horizontal surface when propelled by the child sitting or standing within the walker, and that is in the manufacturer's recommended use position. Examples of different style walkers can be seen in Fig. 1.

4. Calibration and Standardization

4.1 All testing shall be conducted on a concrete floor that may be covered with 1/8 in. (3 mm) thick vinyl floor cover, unless test instructs differently.

4.2 The walker shall be completely assembled, unless otherwise noted, in accordance with the manufacturer's instructions.

4.3 No testing shall be conducted within 48 h of manufacturing.

4.4 The product to be tested shall be in a room with ambient temperature of 73 ± 9°F (23 ± 5°C) for at least 1 h prior to testing. Testing then shall be conducted within this temperature range.

4.5 All testing required by this specification shall be conducted on the same unit.

4.6 The following guidelines shall apply to force gages used for testing:

4.6.1 *Equipment*—Chatillon Model DPPH 25 or equivalent,⁴

4.6.2 *Range*—0 to 25 lbf (110 N),

4.6.3 *Tolerance*—±1 Div.,

4.6.4 *Calibration Interval*—1 year,

4.6.5 *Equipment*—Chatillon Model DPPH 100 or equivalent,⁴

4.6.6 *Range*—0 to 100 lbf (500 N),

4.6.7 *Tolerance*—±1 Div., and

4.6.8 *Calibration Interval*—1 year.

5. General Requirements

5.1 The walker shall conform to the regulations specified in Section 2 of this specification before and after all testing.

5.2 Prior to testing, any exposed wood parts shall be smooth and free from splinters.

5.3 *Latching or Locking Mechanisms*—Any unit that folds shall have a latching or locking device or other provision in the design that will prevent the unit from unintentionally folding when properly placed in the manufacturer's recommended use position. The unit shall remain in its manufacturer's recommended use position during and upon completion of the test, in accordance with 7.2. If a unit is designed with a latching or locking device, that device shall remain engaged and operative after testing.

5.4 *Openings*—Holes or slots that extend entirely through a wall section of any rigid material less than 0.375 in. (9.53 mm) thick and admit a 0.210 in. (5.33 mm) diameter rod shall also admit a 0.375 in. (9.53 mm) diameter rod. Holes or slots that are between 0.210 in. (5.33 mm) and 0.375 in. (9.53 mm) and have a wall thickness less than 0.375 in. (9.53 mm), but are limited in depth to 0.375 in. (9.53 mm) maximum by another rigid surface shall be permissible (see Fig. 2). The product shall be evaluated in all manufacturer's recommended use positions.

5.5 *Scissoring, Shearing, Pinching*—A product, when in a manufacturer's recommended use position, shall be designed

⁴ The sole source of supply of the apparatus known to the committee at this time is John Chatillon and Sons, Inc., 7609 Business Park Dr., Greensboro, NC 27409-9301. If you are aware of alternative suppliers, please provide this information to ASTM Headquarters. Your comments will receive careful consideration at a meeting of the responsible technical committee,¹ which you may attend.

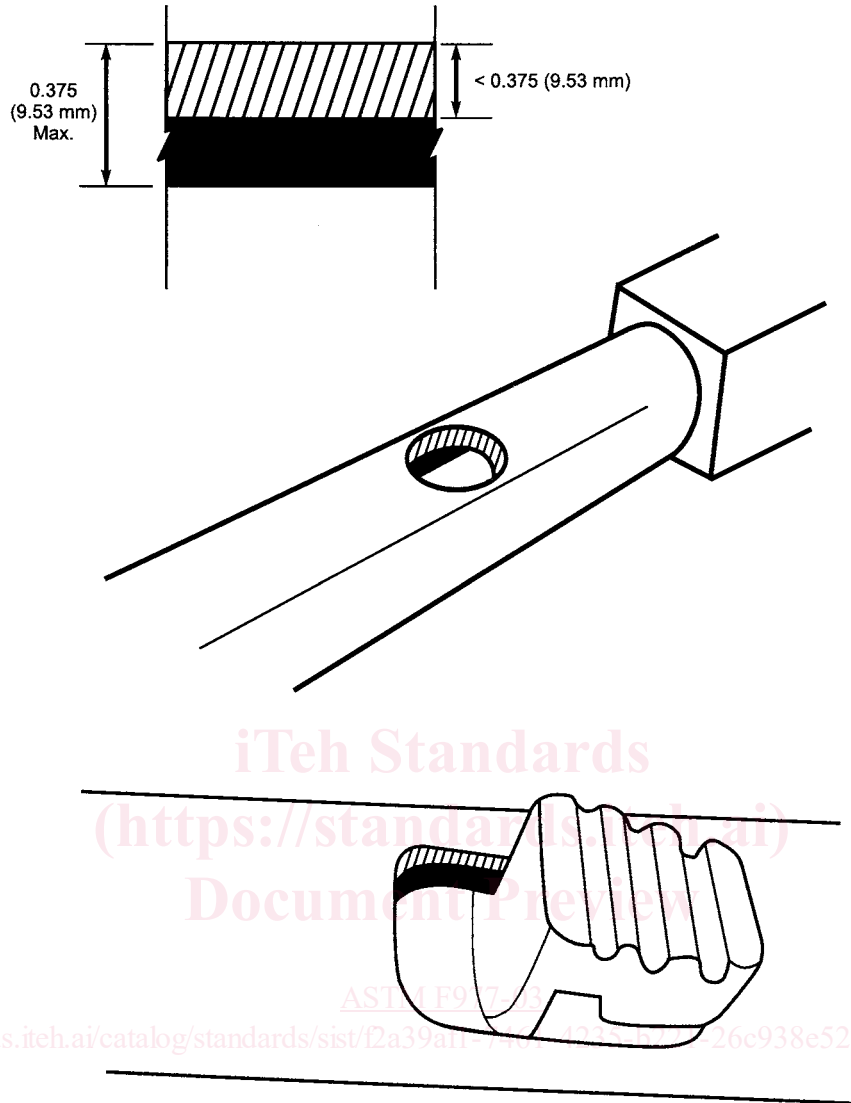

FIG. 2 Opening Examples

and constructed so as to prevent injury to the occupant from any scissoring, shearing, or pinching when members or components rotate about a common axis or fastening point, slide, pivot, fold or otherwise move relative to one another. Scissoring, shearing, or pinching that may cause injury shall not be permissible when the edges of any rigid parts admit a probe greater than 0.210 in. (5.33 mm) and less than 0.375 in. (9.53 mm) diameter at any accessible point throughout the range of motion of such parts.

5.6 *Exposed Coil Springs*—Any exposed coil spring which is accessible to the occupant, having or capable of generating a space between coils of 0.210 in. (5.33 mm) or greater during static load testing in accordance with 7.1.2 shall be covered or otherwise designed to prevent injury from entrapment.

5.7 *Labeling*:

5.7.1 Warning labels, whether paper or non-paper, shall be permanent when tested per 7.4.1-7.4.3.

5.7.2 Warning statements applied directly onto the surface of the product by hot stamping, heat transfer, printing, wood burning, etc. shall be permanent when tested per 7.4.4.

5.7.3 Non-paper labels shall not liberate small parts when tested in accordance with 7.4.5.

5.8 *Protective Components*—If a child can grasp components between the thumb and forefinger, or teeth (such as caps, sleeves, or plugs used for protection from sharp edges, points, or entrapment of fingers or toes), or if there is at least 0.040 in. (1.00 mm) gap between the component and its adjacent parent component, such component shall not be removed when tested in accordance with 7.6.

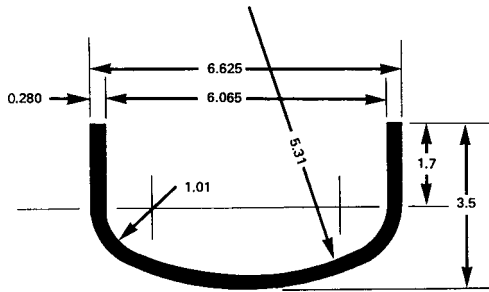

NOTE 1—Caps furnished to ANSI standards unless otherwise specified. Welding caps are formed from steel plate and are ellipsoidal in shape. The minor axis being equal to one half the major axis radii “R” and “r” closely approximate the actual semi-ellipsoidal shape. All dimensions in inches and are in accordance with ANSI B16.9.

FIG. 3 Nominal 6 in. Weld Cap Weight (Approximately) 6.4 lb

6. Performance Requirements

NOTE 1—The forces that are to be applied to the sample in the tests described in Section 7 of this specification are readily applied by means of a calibrated force gage, or in the case of static load and dynamic load tests, by fixed masses.

6.1 Stability:

6.1.1 *Tipping Resistance Against an Immovable Object*—A minimum stability index of 18 shall be required to tip over a walker either forwards or backwards when tested in accordance with 7.3.

6.1.2 *Occupant Leaning Over Edge*—A walker shall remain upright (not tip over) when forces are applied forward, and sideward, in accordance with 7.3.4.

6.2 *Structural Integrity*—All tests that cover static and dynamic loading, and support of the occupant, are to be performed on the same product, sequentially and without refurbishing or repositioning of adjustment, if any. At test conclusion, there shall be no failure of seams, breakage of materials, or changes in adjustments that could cause the unit not to fully support the child or create a hazardous condition as defined in Section 5. Maximum slippage of adjustable features, if any, is 1 in. (25 mm).

6.2.1 *Dynamic Load*—The occupant support member (seat) shall support a dynamic load when tested in accordance with 7.1.1.

6.2.2 *Static Load*—The walker shall not create a hazardous condition as defined in 5.4 when tested in accordance with 7.1.2.

6.2.3 *Occupant Retention*—The seat of the walker shall be designed so that the leg openings will not permit the passage of a 6 in. (150 mm) weld cap (see Fig. 3) when tested in accordance with 7.1.3.

6.3 *Prevention of Falls Down Step(s)*—The walker shall maintain contact with and be supported only by the test platform at the conclusion of the tests in 7.6.

7. Test Methods

NOTE 2—Except for the structural integrity tests (see 7.1), that shall be performed first, the tests can be performed in any sequence.

7.1 Structural Integrity (see 6.2):

NOTE 3—All wood blocks are fabricated from 1 in. nominal thickness

lumber having a finish thickness of ¾ in. (19 mm) unless otherwise stated.

7.1.1 Dynamic Load (see 6.2.1):

7.1.1.1 Position the walker in the manufacturer’s recommended use position with all wheels on the floor. If adjustable, adjust to the highest and most upright position.

7.1.1.2 Affix to the walker seat a 6 by 6 in. (150 by 150 mm) wood block. If the unit has a hammock type seat, use a standard 6 in. weld cap, as identified in Fig. 3. Attach the weld cap to the bottom of the test weight with the convex surface down.

7.1.1.3 Drop a test weight of 33 lb (15.0 kg), with the weight of the weld cap included, onto the seat at least a distance of 1 in. (25 mm) 100 times at a rate of 4 ± 1 seconds per cycle.

7.1.1.4 When testing a spring supported adjustable bouncer walker, test with the unit in the highest adjustment position and support the frame so that the dropping of the 33 lb (15.0 kg) weight does not cause the frame to bottom out artificially.

7.1.2 Static Load (see 6.2.2):

7.1.2.1 Position the walker as in 7.1.1.1.

7.1.2.2 Center a weight of 90 lb (40.8 kg) for a period of 1 min on a 6 by 6 in. (150 by 150 mm) wood block affixed to the walker seat. If the unit has a hammock type seat, use a standard 6 in. (150 mm) weld cap, convex surface down, as identified in Fig. 3 instead of the specified wood block. Include the weight of the weld cap in the 90 lb (40.8 kg) weight. If the natural action of a bouncer type walker will not allow the full application of 90 lb (40.8 kg) static load, then restrict the bouncer mechanism by any means possible so that the full static load can be applied to the seat or section of the walker occupied by the child.

7.1.2.3 Position the walker in the manufacturer’s recommended use position with all wheels on the floor. If adjustable, adjust to the lowest use position.

7.1.2.4 Center a weight of 50 lb (22.7 kg) for a period of 1 minute on a 6 by 6 in. (150 by 150 mm) wood block affixed to the walker seat. If the unit has a hammock type seat, use a standard 6 in. (150 mm) weld cap convex surface face down, as identified in Fig. 3 instead of the specified wood block. Include the weight of the weld cap in the 50 lb (22.7 kg) weight. In this test DO NOT restrict the bouncer mechanism from folding or bottoming out. Observe visually the action of all supporting, locking, and adjusting components to make sure that they do not create a hazardous condition as defined in 5.4.

7.1.3 Occupant Retention Testing (see 6.2.3):

7.1.3.1 Position the walker so that the plane of a leg opening is horizontal.

7.1.3.2 Center the convex surface of a 6 in. (150 mm) weld cap in the leg opening so that the weight of the weld cap is supported by the material adjacent to the leg opening.

7.1.3.3 Maintain for 10 s.

7.1.3.4 Repeat 7.1.3.1-7.1.3.3 for the other leg opening.

7.2 Latching or Locking Mechanisms (see 5.3):

7.2.1 Erect the walker in accordance with the manufacturer’s instructions and adjust to the highest and most upright recommended use position.

7.2.2 Position the walker so that the normal folding motion is not impeded.

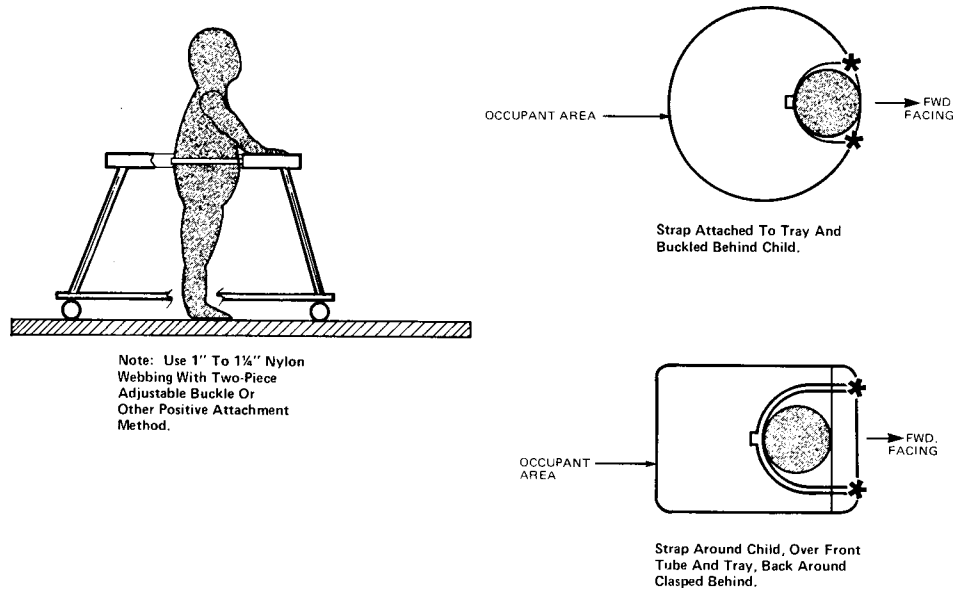

FIG. 4 Placement of CAMI Infant Dummy

7.2.3 Apply a force of 10 lbf (44 N) in the direction normally associated with folding the walker in accordance with manufacturer’s instructions. Apply the force gradually over a 5 s period and maintain for an additional 10 s before releasing the force.

7.2.4 Perform this procedure for a total of five times within a 2 min period.

7.3 Stability Test (see 6.1):

7.3.1 *Tipping Resistance Against An Immovable Object* (see 6.1.1)—Establish a horizontal test plane with a piece of ½ in. (13 mm) high by ¾ in. (19 mm) wide aluminum angle stop affixed thereto. Its length shall be a minimum of 6 in. (150 mm) wider than the width of the walker being tested.

7.3.2 *Forward Tip Resistance:*

7.3.2.1 Place the walker on the horizontal test plane and adjust it to the manufacturer’s highest recommended use position. If the walker has a reclinable seat, place it in its most upright position. Place a six month old CAMI Infant Dummy Mark II⁵ in the walker and affix it in a position so that its feet just touch the test plane and its abdomen is positioned firmly against the forward edge of the occupant area (see Fig. 4). If the Dummy’s feet do not touch the test plane when the walker is in its highest use position, lower the walker until the Dummy’s feet just touch the test plane.

7.3.2.2 Position the walker so that its two most forward wheels are touching and perpendicular to the aluminum stop. For walkers that have offset wheels, place the wheels in the most disadvantageous position.

7.3.2.3 Pretension by gradually applying 3 lbf (13 N) forward horizontal force at a level just below the CAMI Dummy’s⁵ armpits in a direction perpendicular to the axis connecting the two most forward wheels and centered halfway

between the wheels (see Fig. 5). Then increase the horizontal force until the walker tips over forward.

7.3.2.4 Record the distance pulled in inches after pre-tensioning and the maximum force exerted in pounds (including pre-tensioning). The sum of the distance pulled and maximum force exerted shall be considered the stability index.

7.3.3 *Rear Tip Resistance:*

7.3.3.1 Without adjusting the seat height or the height of the CAMI Dummy⁵ relative to the horizontal test plane, position the Dummy so that its back is firmly against the rear of the occupant area.

7.3.3.2 Position the walker so that its two most rearward wheels are touching and perpendicular to the aluminum stop. For walkers that have offset wheels, place wheels in the most disadvantageous position.

7.3.3.3 Pretension by gradually applying a 3 lbf (13 N) horizontal force in a rearward direction perpendicular to the axis connecting the two most rear wheels and centered between the wheels. Apply the force at a level just below the CAMI Dummy’s⁵ armpits. Then increase the force until the walker tips over. If the walker has a seat pad whose back is higher than the Dummy’s armpits, apply the horizontal force at the same height as that of the Dummy’s armpits.

7.3.3.4 Record the distance pulled in inches after pre-tensioning and the maximum force exerted in pounds including pre-tensioning. The sum of the distance pulled and the maximum force exerted shall be considered the stability index.

7.3.4 *Occupant Leaning Outward Over Edge of Walker* (see 6.1.2):

7.3.4.1 Position walker in the manufacturer’s recommended use position with all wheels on the floor (flat horizontal plane). For walkers that have offset wheels, place wheels in the most disadvantageous position. If the walker is adjustable, adjust to its highest use position.

⁵ CAMI Infant Dummy (Mark II), Department of Transportation, Memorandum Report AAC-119-74-14, Revision II, Drawing No. SA-1101 (see Fig. 6).

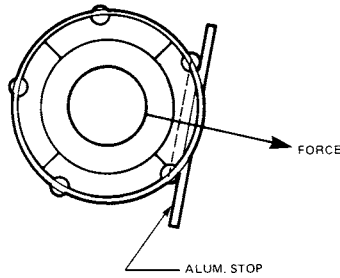

TIP RESISTANCE SETUP

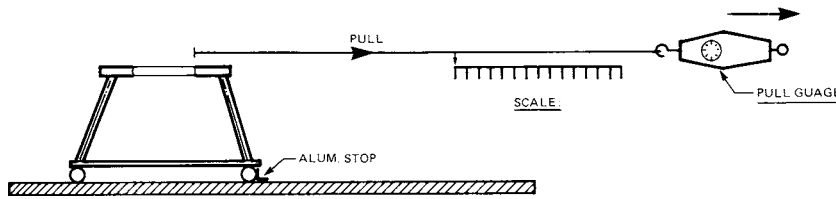
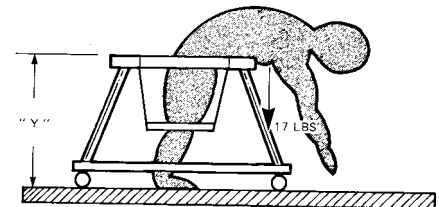
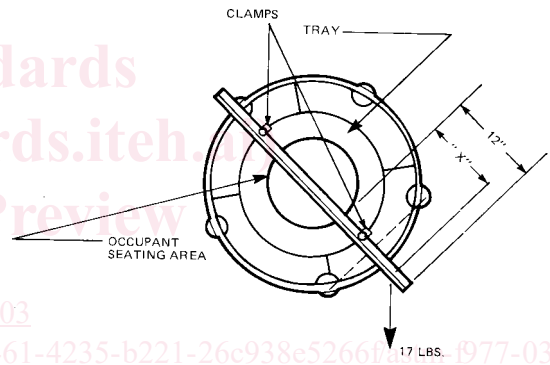

FIG. 5 Tip Resistance Setup



NOTE 1—This CAMI Infant Dummy was constructed in accordance with the Department of Transportation Specification dated April 29, 1975.

FIG. 6 CAMI Infant Dummy—Mark II



NOTE 1—X inches depends on height of walker, Y = height of walker tray or uppermost frame member.

FIG. 7 Leaning Over Setup

7.3.4.2 Clamp a 1 by 1 in. (25 by 25 mm) rigid aluminum angle to the uppermost front and rear horizontal frame members of the walker in a direction perpendicular to the axis of the two most forward wheels and centered between the wheels. The length of the aluminum angle should be such that it extends forward at least 12 in. (300 mm) beyond the front edge of the occupant seating area (see Fig. 7).

7.3.4.3 Locate the point on the aluminum angle that is 1 in. (25 mm) less than one half the difference between 32 in. (810 mm), and the height of the walker at the top edge of the tray adjacent to the seating area (see Fig. 7). Over a period of 5 s,

gradually apply a vertically downward force of 17 lb to this point and maintain it for an additional 10 s.

NOTE 4—32 in. is the maximum height of the user.

7.3.4.4 Repeat the steps in 7.3.4.1, 7.3.4.2, and 7.3.4.3, except position the aluminum angle in a sideward direction perpendicular to the axis connecting the two most sideward wheels and centered halfway between the wheels. Be sure the