



Designation: D 143 – 94 (Reapproved 2000)<sup>e1</sup>

## Standard Test Methods for Small Clear Specimens of Timber<sup>1</sup>

This standard is issued under the fixed designation D 143; the number immediately following the designation indicates the year of original adoption or, in the case of revision, the year of last revision. A number in parentheses indicates the year of last approval. A superscript epsilon ( $\epsilon$ ) indicates an editorial change since the last revision or reapproval.

*This standard has been approved for use by agencies of the Department of Defense.*

---

<sup>e1</sup> NOTE—Keywords were added in April 2000.

---

### INTRODUCTION

The need to classify wood species by evaluating the physical and mechanical properties of small clear specimens has always existed. Because of the great variety of species, variability of the material, continually changing conditions of supply, many factors affecting test results, and ease of comparing variables, the need will undoubtedly continue to exist.

In the preparation of these methods for testing small clear specimens, consideration was given both to the desirability of adopting methods that would yield results comparable to those already available and to the possibility of embodying such improvements as experience has shown desirable. In view of the many thousands of tests made under a single comprehensive plan by the U.S. Forest Service, the former Forest Products Laboratories of Canada (now Forintek Canada Corp.), and other similar organizations, the methods naturally conform closely to the methods used by these institutions. These methods are the outgrowth of a study of both American and European experience and methods. The general adoption of these methods will tend toward a world-wide unification of results, permitting an interchange and correlation of data, and establishing the basis for a cumulative body of fundamental information on the timber species of the world.

Descriptions of some of the strength tests refer to primary methods and secondary methods. Primary methods provide for specimens of 2 by 2-in. (50 by 50-mm) cross-section. This size of specimen has been extensively used for the evaluation of various mechanical and physical properties of different species of wood, and a large number of data based on this primary method have been obtained and published.

The 2 by 2-in. (50 by 50-mm) size has the advantage in that it embraces a number of growth rings, is less influenced by earlywood and latewood differences than smaller size specimens, and is large enough to represent a considerable portion of the sampled material. It is advisable to use primary method specimens wherever possible. There are circumstances, however, when it is difficult or impossible to obtain clear specimens of 2 by 2-in. cross section having the required 30 in. (760 mm) length for static bending tests. With the increasing incidence of smaller second growth trees, and the desirability in certain situations to evaluate a material which is too small to provide a 2 by 2-in. cross-section, a secondary method which utilizes a 1 by 1-in. (25 by 25-mm) cross section has been included. This cross section is established for compression parallel to grain and static bending tests, while the 2 by 2-in. cross-section is retained for impact bending, compression perpendicular to grain, hardness, shear parallel to grain, cleavage, and tension perpendicular to grain. Toughness and tension parallel to grain are special tests using specimens of smaller cross section.

The user is cautioned that test results between two different sizes of specimens are not necessarily directly comparable. Guidance on the effect of specimen size on a property being evaluated is beyond the scope of these methods, and should be sought elsewhere.

Where the application, measurement, or recording of load and deflection can be accomplished using electronic equipment and computerized apparatus, such devices are encouraged, providing they do not lower the standard of accuracy and reliability available with basic mechanical equipment.

**1. Scope**

1.1 These methods cover the determination of various strength and related properties of wood by testing small clear specimens.

1.1.1 These methods represent procedures for evaluating the different mechanical and physical properties, controlling factors such as specimen size, moisture content, temperature, and rate of loading.

1.1.2 Sampling and collection of material is discussed in Practice D 5536. Sample data, computation sheets, and cards have been incorporated, which were of assistance to the investigator in systematizing records.

1.1.3 The values stated in inch-pound units are to be regarded as the standard. The SI values are given in parentheses and are provided for information only. When a weight is prescribed, the basic inch-pound unit of weight (lbf) and the basic SI unit of mass (Kg) are cited.

1.2 The procedures for the various tests appear in the following order:

	Sections
Photographs of Specimens	5
Control of Moisture Content and Temperature	6
Record of Heartwood and Sapwood	7
Static Bending	8
Compression Parallel to Grain	9
Impact Bending	10
Toughness	11
Compression Perpendicular to Grain	12
Hardness	13
Shear Parallel to Grain	14
Cleavage	15
Tension Parallel to Grain	16
Tension Perpendicular to Grain	17
Nail Withdrawal	18
Specific Gravity and Shrinkage in Volume	19
Radial and Tangential Shrinkage	20
Moisture Determination	21
Permissible Variations	22
Calibration	23

1.3 *This standard does not purport to address all of the safety concerns, if any, associated with its use. It is the responsibility of the user of this standard to establish appropriate safety and health practices and determine the applicability of regulatory limitations prior to use.*

**2. Referenced Documents**

2.1 *ASTM Standards:*

- D 198 Methods for Static Tests of Timbers in Structural Sizes<sup>2</sup>
- D 2395 Test Methods for Specific Gravity of Wood and Wood-Base Materials<sup>2</sup>
- D 3043 Methods of Testing Structural Panels in Flexure<sup>2</sup>
- D 3500 Test Method for Structural Panels in Tension<sup>2</sup>
- D 4442 Test Methods for Direct Moisture Content Measurement of Wood and Wood-Base Materials<sup>2</sup>

- D 4761 Test Method for Mechanical Properties of Lumber and Wood-Base Structural Material<sup>2</sup>
- D 5536 Practice for Sampling the Forest Trees for Determination of Clear Wood Properties<sup>2</sup>
- E 4 Practices for Force Verification of Testing Machines<sup>3</sup>

**3. Summary of Methods**

3.1 The mechanical tests are static bending, compression parallel to grain, impact bending toughness, compression perpendicular to grain, hardness, shear parallel to grain (Note 1), cleavage, tension parallel to grain, tension-perpendicular-to-grain, and nail-withdrawal tests. These tests may be made on both green and air-dry material as specified in these methods. In addition, methods for evaluating such physical properties as specific gravity, shrinkage in volume, radial shrinkage, and tangential shrinkage are presented.

NOTE 1—The test for shearing strength perpendicular to the grain (sometimes termed “vertical shear”) is not included as one of the principal mechanical tests since in such a test the strength is limited by the shearing resistance parallel to the grain.

**4. Significance and Use**

4.1 These methods cover tests on small clear specimens of wood that are made to provide the following:

- 4.1.1 Data for comparing the mechanical properties of various species,
- 4.1.2 Data for the establishment of correct strength functions, which in conjunction with results of tests of timbers in structural sizes (see Methods D 198 and Test Method D 4761), afford a basis for establishing allowable stresses, and
- 4.1.3 Data to determine the influence on the mechanical properties of such factors as density, locality of growth, position in cross section, height of timber in the tree, change of properties with seasoning or treatment with chemicals, and change from sapwood to heartwood.

**5. Photographs of Specimens**

5.1 Four of the static bending specimens from each species shall be selected for photographing, as follows: two average growth, one fast growth, and one slow growth. These specimens shall be photographed in cross section and on the radial and tangential surfaces. Fig. 1 is a typical photograph of a cross section of 2 by 2-in. (50 by 50-mm) test specimens, and Fig. 2 is the tangential surface of such specimens.

**6. Control of Moisture Content and Temperature**

6.1 In recognition of the significant influence of temperature and moisture content on the strength of wood, it is highly desirable that these factors be controlled to ensure comparable test results.

6.2 *Control of Moisture Content*—Specimens for the test in the air-dry condition shall be dried to approximately constant weight before test. Should any changes in moisture content occur during final preparation of specimens, the specimens shall be reconditioned to constant weight before test. Tests shall be carried out in such manner that large changes in

<sup>1</sup> These methods are under the jurisdiction of ASTM Committee D7 on Wood and are the direct responsibility of Subcommittee D07.01 on Fundamental Test Methods and Properties.

Current edition approved May 15, 1994. Published July 1994. Originally published as D 143 – 22 T. Last previous edition D 143 – 83.

<sup>2</sup> Annual Book of ASTM Standards, Vol 04.10.

<sup>3</sup> Annual Book of ASTM Standards, Vol 03.01.

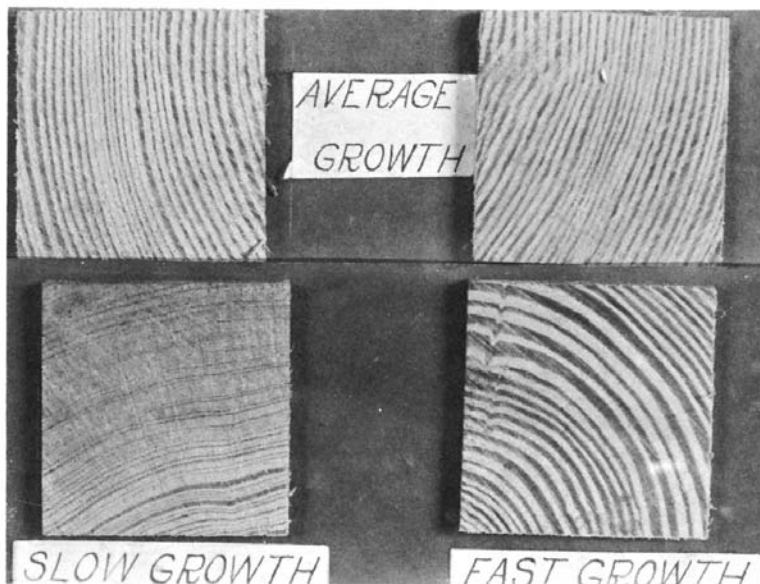

FIG. 1 Cross Sections of Bending Specimens Showing Different Rates of Growth of Longleaf Pine (2 by 2-in. (50 by 50-mm) Specimens)



FIG. 2 Tangential Surfaces of Bending Specimens of Different Rates of Growth of Jeffrey Pine 2 by 2-in. (50 by 50 by 760-mm) Specimens

moisture content will not occur. To prevent such changes, it is desirable that the testing room and rooms for preparation of test specimens have some means of humidity control.

6.3 *Control of Temperature*—Temperature and relative humidity together affect wood strength by fixing its equilibrium moisture content. The mechanical properties of wood are also affected by temperature alone. When tested, the specimens shall be at a temperature of 68 + 6°F (20 + 3°C). The temperature at the time of test shall in all instances be recorded as a specific part of the test record.

## 7. Record of Heartwood and Sapwood

7.1 *Proportion of Sapwood*—The estimated proportion of sapwood present should be recorded for each test specimen.

## 8. Static Bending

8.1 *Size of Specimens*—The static bending tests shall be made on 2 by 2 by 30 in. (50 by 50 by 760 mm) primary

method specimens or 1 by 1 by 16 in. (25 by 25 by 410 mm) secondary method specimens. The actual height and width at the center and the length shall be measured (see 22.2).

8.2 *Loading Span and Supports*—Use center loading and a span length of 28 in. (710 mm) for the primary method and 14 in. (360 mm) for the secondary method. These spans were established in order to maintain a minimum span-to-depth ratio of 14. Both supporting knife edges shall be provided with bearing plates and rollers of such thickness that the distance from the point of support to the central plane is not greater than the depth of the specimen (Fig. 3). The knife edges shall be adjustable laterally to permit adjustment for slight twist in the specimen (Note 2).

NOTE 2—Details of laterally adjustable supports may be found in Fig. 1 of Methods D 3043.

8.3 *Bearing Block*—A bearing block of the form and size of that shown in Fig. 4 shall be used for applying the load for



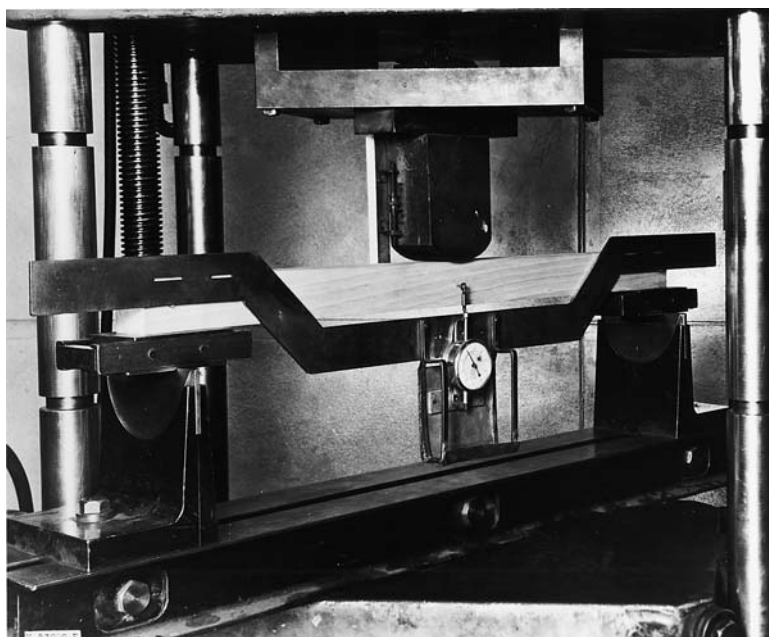

FIG. 3 Static Bending Test Assembly Showing Method of Load Application, Specimen Supported on Rollers and Laterally Adjustable Knife Edges, and Method of Measuring Deflection at Neutral Axis by Means of Yoke and Dial Attachment (Adjustable scale mounted on loading head is used to measure increments of deformation beyond the dial capacity.)

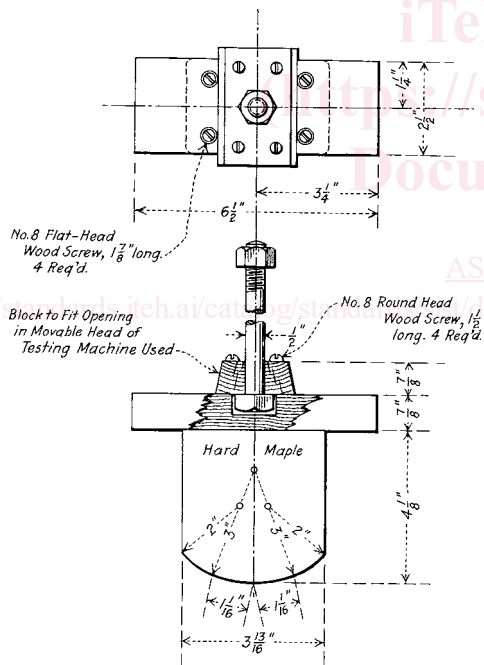

FIG. 4 Details of Bearing Block for Static Bending Tests

primary method specimens. A block having a radius of 1 1/2 in. (38 mm) for a chord length of not less than 2 in. (50 mm) shall be used for secondary method specimens.

8.4 Placement of Growth Rings—The specimen shall be placed so that the load will be applied through the bearing block to the tangential surface nearest the pith.

8.5 Speed of Testing—The load shall be applied continuously throughout the test at a rate of motion of the movable crosshead of 0.10 in. (2.5 mm)/min (see 22.3), for primary

method specimens, and at a rate of 0.05 in. (1.3 mm)/min for secondary method specimens.

8.6 Load-Deflection Curves:

8.6.1 Load-deflection curves shall be recorded to or beyond the maximum load for all static bending tests. The curves shall be continued to a 6 in. (150 mm) deflection, or until the specimen fails to support a load of 200 lbf (890 N) for primary method specimens and to a 3 in. (76 mm) deflection or until the specimen fails to support a load of 50 lbf (220 N) for secondary method specimens.

8.6.2 Deflections of the neutral plane at the center of the length shall be taken with respect to points in the neutral plane above the supports. Alternatively, deflection may be taken relative to the tension surface at midspan. However, take care to ensure that vertical displacements which may occur at the reactions are accounted for.

8.6.3 Within the proportional limit, deflection readings shall be taken to 0.001 in. (0.02 mm). After the proportional limit is reached, less refinement is necessary in observing deflections, but it is convenient to read them by means of the dial gage (Fig. 3) until it reaches the limit of its capacity, normally approximately 1 in. (25 mm). Where deflections beyond 1 in. are encountered, the deflections may be measured by means of the scale mounted on the loading head (Fig. 3) and a wire mounted at the neutral axis of the specimen of the side opposite the yoke. Deflections are read to the nearest 0.01 in. (0.2 mm) at 0.10 in. (2.5 mm) intervals and also after abrupt changes in load.

8.6.4 The load and deflection of first failure, the maximum load, and points of sudden change shall be read and shown on the curve sheet (Note 3) although they may not occur at one of the regular load or deflection increments.

NOTE 3—See Fig. 5 for a sample static bending data sheet form.

FILE NO. 124  
 COST CHARGE \_\_\_\_\_  
 LABORATORY NO. 100,831

U. S. DEPARTMENT OF AGRICULTURE  
 FOREST SERVICE

MEASURED \_\_\_\_\_  
 TESTED \_\_\_\_\_  
 WEIGHED \_\_\_\_\_

STATION - MADISON DATE - AUG. 24, 1914 SHIP NO. L-315 STICK NO. S-8  
 PIECE NO. 4 MARK d

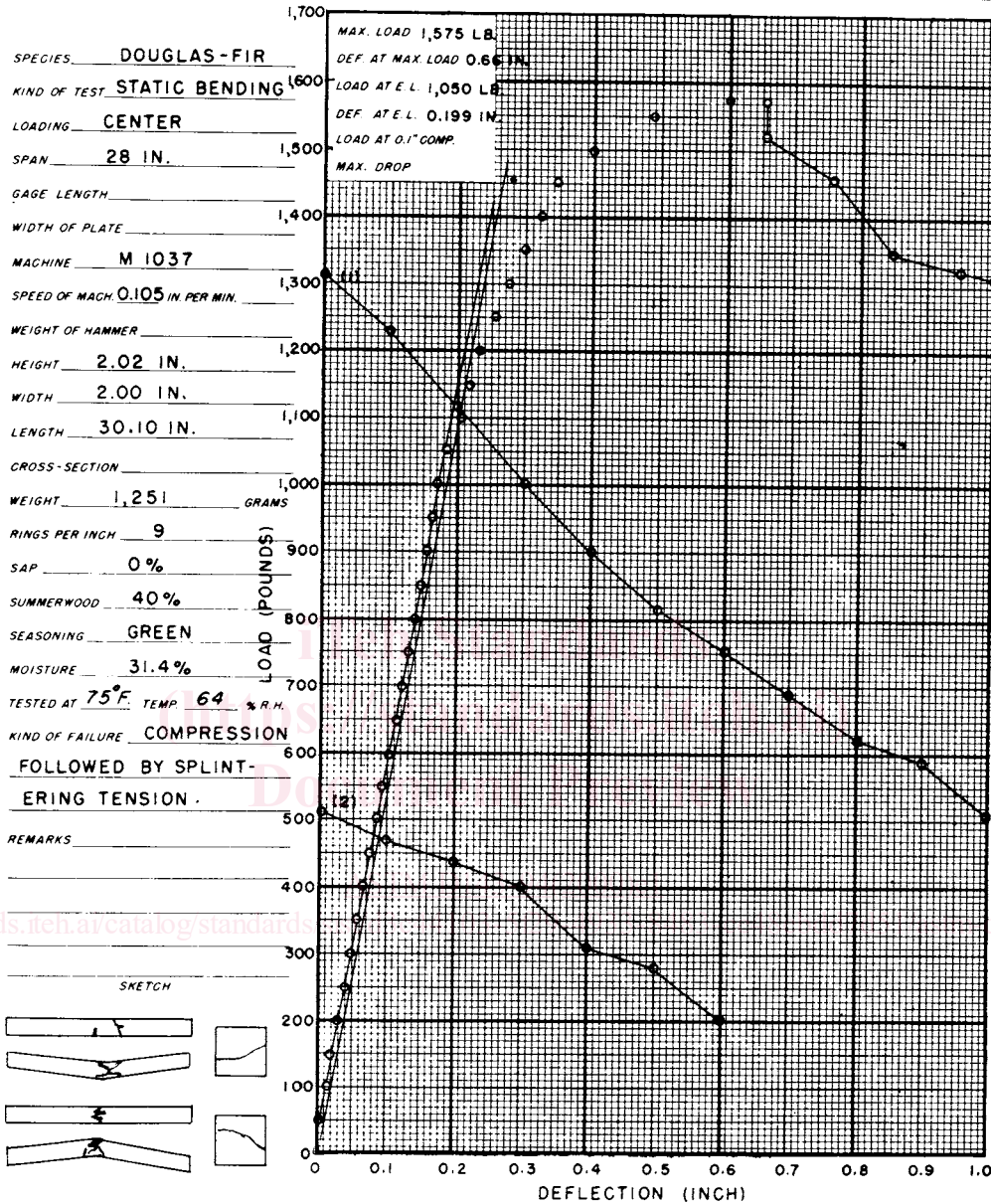

FIG. 5 Sample Data Sheet for Static Bending Test

8.7 *Description of Static Bending Failures*—Static bending (flexural) failures shall be classified in accordance with the appearance of the fractured surface and the manner in which the failure develops (Fig. 6). The fractured surfaces may be roughly divided into “brash” and “fibrous”, the term “brash” indicating abrupt failure and “fibrous” indicating a fracture showing splinters.

8.8 *Weight and Moisture Content*—The specimen shall be weighed immediately before test, and after the test a moisture section approximately 1 in. (25 mm) in length shall be cut from the specimen near the point of failure. (see 21.1 and 22.1).

## 9. Compression Parallel to Grain

9.1 *Size of Specimens*—The compression-parallel-to-grain tests shall be made on 2 by 2 by 8 in. (50 by 50 by 200 mm) primary method specimens, or 1 by 1 by 4 in. (25 by 25 by 100 mm) secondary method specimens. The actual cross-sectional dimensions and the length shall be measured (see 22.2).

9.2 *End Surfaces Parallel*—Special care shall be used in preparing the compression-parallel-to-grain test specimens to ensure that the end grain surfaces will be parallel to each other and at right angles to the longitudinal axis. At least one platen

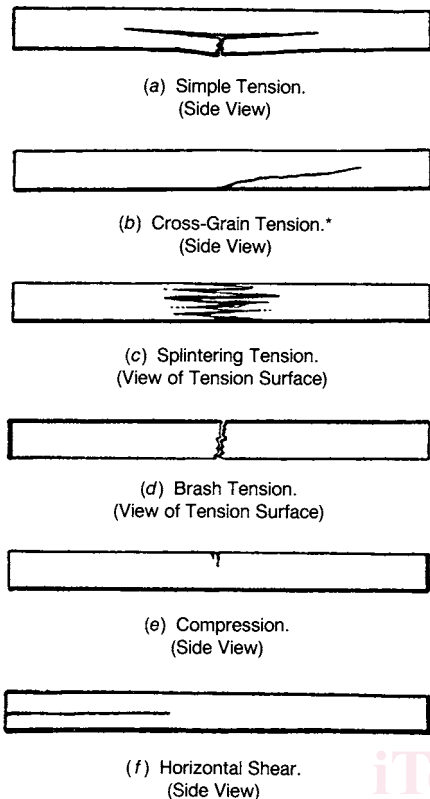

NOTE 1—The term “cross grain” shall be considered to include all deviations of grain from the direction of the longitudinal axis or longitudinal edges of the specimen. It should be noted that spiral grain may be present even to a serious extent without being evident from a casual observation.

NOTE 2—The presence of cross grain have a slope that deviates more than 1 in 20 from the longitudinal edges of the specimen shall be cause for culling the test.

FIG. 6 Types of Failures in Static Bending

of the testing machine shall be equipped with a spherical bearing to obtain uniform distribution of load over the ends of the specimen.

9.3 *Speed of Testing*—The load shall be applied continuously throughout the test at a rate of motion of the movable crosshead of 0.003 in./in. (mm/mm) of nominal specimen length/min (see 22.3).

#### 9.4 *Load-Compression Curves:*

9.4.1 Load-compression curves shall be taken over a central gage length not exceeding 6 in. (150 mm) for primary method specimens, and 2 in. (50 mm) for secondary method specimens. Load-compression readings shall be continued until the proportional limit is well passed, as indicated by the curve (Note 4).

NOTE 4—See Fig. 7 for a sample compression-parallel-to-grain data sheet form.

9.4.2 Deformations shall be read to 0.0001 in. (0.002 mm).

9.4.3 Figs. 8 and 9 illustrate two types of compressometers that have been found satisfactory for wood testing. Similar apparatus is available for measurements of compression over a 2 in. (50 mm) gage length.

9.5 *Position of Test Failures*—In order to obtain satisfactory and uniform results, it is necessary that the failures be made to develop in the body of the specimen. With specimens of uniform cross section, this result can best be obtained when the ends are at a very slightly lower moisture content than the body. With green material, it will usually suffice to close-pile the specimens, cover the body with a damp cloth, and expose the ends for a short time. For dry material, it may sometimes be advisable to pile the specimens in a similar manner and place them in a desiccator, should the failures in test indicate that a slight end-drying is necessary.

9.6 *Descriptions of Compression Failures*—Compression failures shall be classified in accordance with the appearance of the fractured surface (Fig. 10). In case two or more kinds of failures develop, all shall be described in the order of their occurrence; for example, shearing followed by brooming. The failure shall also be sketched in its proper position on the data sheet.

9.7 *Weight and Moisture Content*—See 8.8.

9.8 *Ring and Latewood Measurement*—When practicable, the number of rings per inch (average ring width in millimetres) and the proportion of summerwood shall be measured over a representative inch (centimetre) of cross section of the test specimen. In determining the proportion of summerwood, it is essential that the end surface be prepared so as to permit accurate latewood measurement. When the fibers are broomed over at the ends from sawing, a light sanding, planing, or similar treatment of the ends is recommended.

## 10. Impact Bending

10.1 *Size of Specimens*—The impact bending tests shall be made on 2 by 2 by 30 in. (50 by 50 by 760 mm) specimens. The actual height and width at the center and the length shall be measured (see 22.2).

10.2 *Loading and Span*—Use center loading and a span length of 28 in. (710 mm).

10.3 *Bearing Block*—A metal tup of curvature corresponding to the bearing block shown in Fig. 4 shall be used in applying the load.

10.4 *Placement of Growth Rings*—The specimen shall be placed so that the load will be applied through the bearing block to the tangential surface nearest the pith.

10.5 *Procedure*—Make the tests by increment drops in a Hatt-Turner or similar impact machine (see Fig. 11). The first drop shall be 1 in. (25 mm), after which increase the drops by 1 in. increments until a height of 10 in. (250 mm) is reached. Then use a 2 in. (50 mm) increment until complete failure occurs or a 6 in. (150 mm) deflection is reached.

10.6 *Weight of Hammer*—A 50 lbf (22.5 kg) hammer shall be used when, with drops up to the capacity of the machine (about 68 in. (1.7 m) for the small Hatt-Turner impact machine), it is practically certain that complete failure or a 6 in. (150 mm) deflection will result for all specimens of a species. For all other cases, a 100 lbf (45 kg) hammer shall be used.

10.7 *Deflection Records*—When desired, graphical drum records (Note 5) giving the deflection for each drop and the set, if any, shall be made until the first failure occurs. This record will also afford data from which the exact height of drop can be scaled for at least the first four falls.



FILE NO. 124  
 COST CHARGE \_\_\_\_\_  
 LABORATORY NO. 871,902

U. S. DEPARTMENT OF AGRICULTURE  
 FOREST SERVICE

MEASURED \_\_\_\_\_  
 TESTED \_\_\_\_\_  
 WEIGHED \_\_\_\_\_

STATION - MADISON DATE - NOV. 5, 1943 SHIP NO. 1590 STICK NO. S-5  
 PIECE NO. 5 MARK d

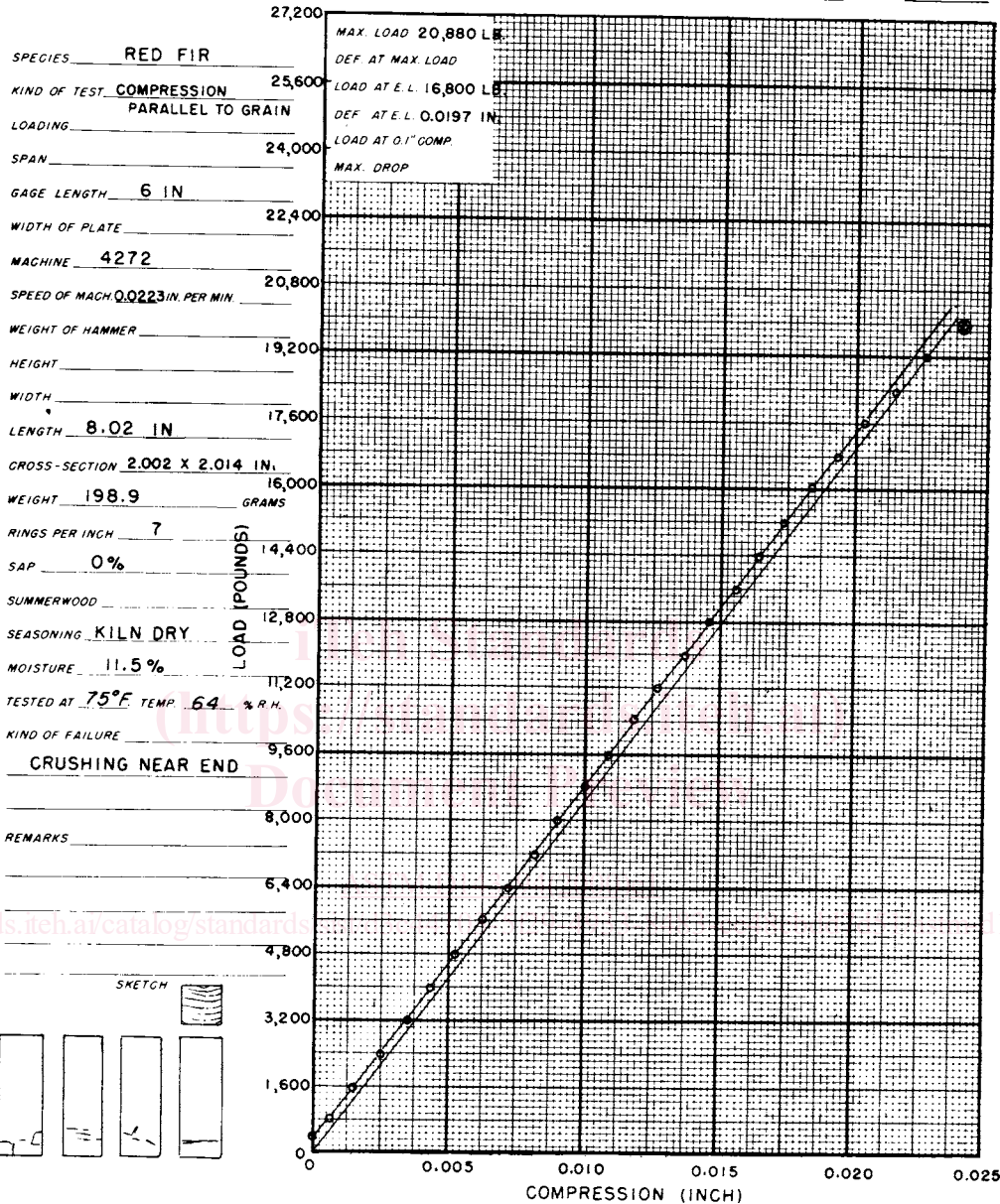

FIG. 7 Sample Data Sheet for Compression-Parallel-to-Grain Test

NOTE 5—See Fig. 12 for a sample drum record.

10.8 *Drop Causing Failure*—The height of drop causing either complete failure or a 6 in. (150 mm) deflection shall be observed for each specimen.

10.9 *Description of Failure*—The failure shall be sketched on the data sheet (Note 6) and described in accordance with the directions for static bending in 8.7.

NOTE 6—See Fig. 13 for a sample impact bending data sheet form. Fig. 14 shows a sample data and computation card.

10.10 *Weight and Moisture Content*—See 8.8.

### 11. Toughness

11.1 A single-blow impact test on a small specimen is recognized as a valuable and desirable test. Several types of machines such as the Toughness, Izod and Amsler have been used, but insufficient information is available to decide whether one procedure is superior to another, or whether the results by the different methods can be directly correlated. If the Toughness machine is used, the following procedure has been found satisfactory. To aid in standardization and to facilitate comparisons, the size of the toughness specimen has been made equal to that accepted internationally.

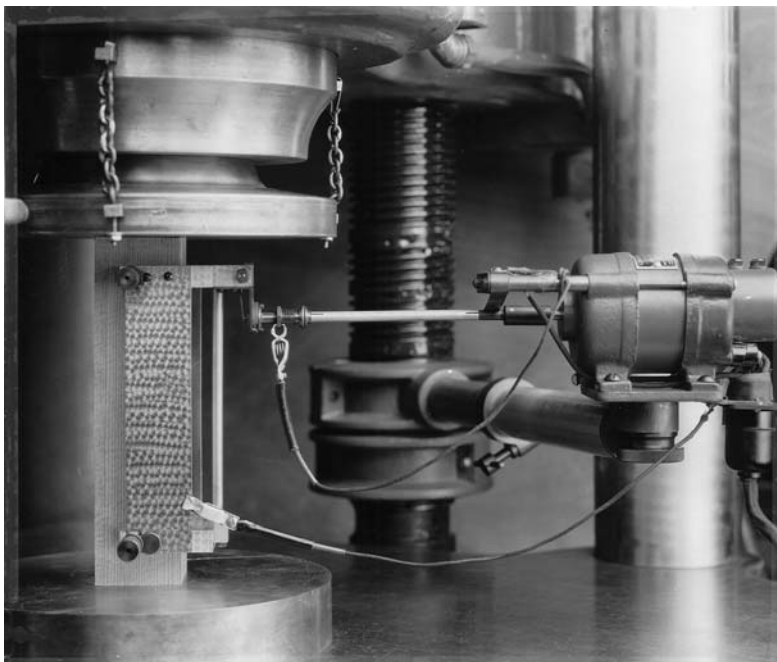

FIG. 8 Compression-Parallel-to-Grain Test Assembly Using an Automatic Type of Compressometer to Measure Deformations (The wire in the lower right-hand corner connects the compressometer with the recording unit.)

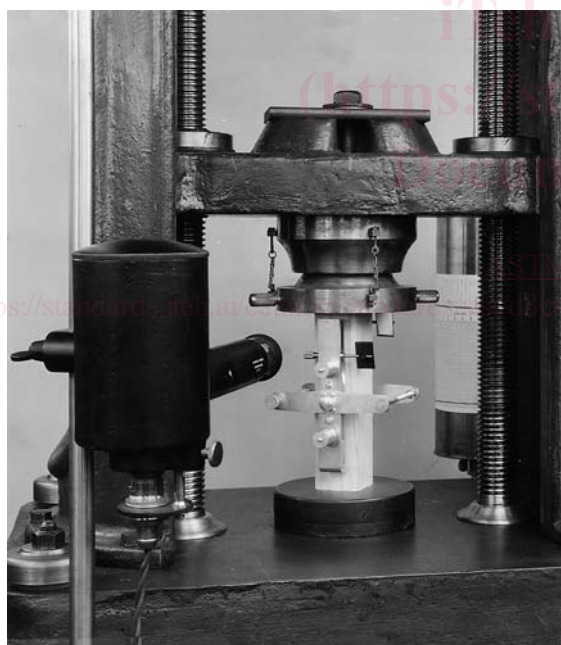

FIG. 9 Compression-Parallel-to-Grain Test Assembly Showing Method of Measuring Deformations by Means of Roller-Type Compressometer

11.2 *Size of Specimen*—The toughness tests shall be made on 0.79 by 0.79 by 11 in. (20 by 20 by 280 mm) specimens. The actual height and width at the center and the length shall be measured (see 22.2).

11.3 *Loading and Span*—Center loading and a span length of 9.47 in. (240 mm) shall be used. The load shall be applied to a radial or tangential surface on alternate specimens.

11.4 *Bearing Block*—An aluminum tup (Fig. 15) having a radius of 3/4 in. (19 mm) shall be used in applying the load.

11.5 *Apparatus and Procedure*—Make the tests in a pendulum type toughness machine (Note 7) (See Fig. 15). Adjust the machine before test so that the pendulum hangs vertically, and adjust it to compensate for friction. Adjust the cable so that the load is applied to the specimen when the pendulum swings to 15° from the vertical, so as to produce complete failure by the time the downward swing is completed. Choose the weight position and initial angle (30, 45, or 60°) of the pendulum, so that complete failure of the specimen is obtained on one drop. Most satisfactory results are obtained when the difference between the initial and final angle is at least 10°.

NOTE 7—Many pendulum-type toughness machines are based on a design developed and used at the USDA Forest Products Laboratory in Madison, Wisconsin.

11.6 *Calculation*—The initial and final angle shall be read to the nearest 0.1° by means of the vernier (Fig. 15) attached to the machine (Note 8).

NOTE 8—See Fig. 16 for sample data and computation sheet for the toughness test.

The toughness shall then be calculated as follows:

$$T = wL(\cos A_2 - \cos A_1) \quad (1)$$

where:

- $T$  = toughness (work per specimen, in. · lbf (Nm),
- $w$  = weight of pendulum, lbf (N),
- $L$  = distance from center of the supporting axis to center of gravity of the pendulum, in. (m),
- $A_1$  = initial angle (Note 9), degrees, and
- $A_2$  = final angle the pendulum makes with the vertical after failure of the test specimen, degrees.

NOTE 9—Since friction is compensated for in the machine adjustment, the initial angle may be regarded as exactly 30, 45, or 60°, as the case may be.



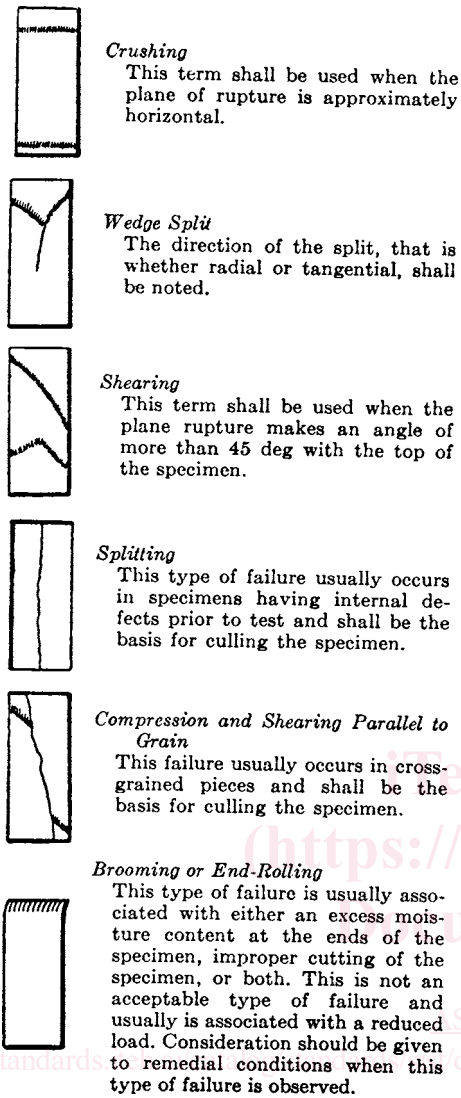

FIG. 10 Types of Failures in Compression

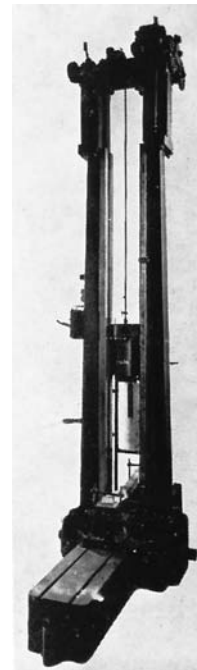

FIG. 11 Hatt-Turner Impact Machine, Illustrating Method of Conducting Impact Bending Test



FIG. 12 Sample Drum Record of Impact Bending Test

11.7 *Weight and Moisture Content*—The specimen shall be weighed immediately before test, and after test a moisture section approximately 2 in. (50 mm) in length shall be cut from the specimen near the failure (see 21.1 and 22.1).

**12. Compression Perpendicular to Grain**

12.1 *Size of Specimens*—The compression-perpendicular-to-grain tests shall be made on 2 by 2 by 6 in. (50 by 50 by 150 mm) specimens. The actual height, width, and length shall be measured (see 22.2).

12.2 *Loading*—The load shall be applied through a metal bearing plate 2 in. (50 mm) in width, placed across the upper surface of the specimen at equal distances from the ends and at right angles to the length (Fig. 17). The actual width of the bearing plate shall be measured (see 22.2).

12.3 *Placement of Growth Rings*—The specimens shall be placed so that the load will be applied through the bearing plate to a radial surface.

12.4 *Speed of Testing*—The load shall be applied continuously throughout the test at a rate of motion of the movable crosshead of 0.012 in. (0.305 mm)/min (see 22.3).

12.5 *Load-Compression Curves:*

12.5.1 Load-compression curves (Note 10) shall be taken for all specimens up to 0.1 in. (2.5 mm) compression, after which the test shall be discontinued. Compression shall be measured between the loading surfaces.

FILE NO. 124  
 COST CHARGE \_\_\_\_\_  
 LABORATORY NO. 101,151

U. S. DEPARTMENT OF AGRICULTURE  
 FOREST SERVICE

STATION - MADISON DATE - AUG. 26, 1914 SHIP NO. L-315 STICK NO. E-12  
 MEASURED \_\_\_\_\_  
 TESTED \_\_\_\_\_  
 WEIGHED \_\_\_\_\_  
 PIECE NO. 1 MARK C

SPECIES DOUGLAS-FIR  
 KIND OF TEST IMPACT BENDING  
 LOADING CENTER  
 SPAN 28 IN.  
 GAGE LENGTH \_\_\_\_\_  
 WIDTH OF PLATE \_\_\_\_\_  
 MACHINE HATT-TURNER  
 SPEED OF MACH \_\_\_\_\_ IN PER MIN \_\_\_\_\_  
 WEIGHT OF HAMMER 50 LB.  
 HEIGHT 2.00 IN.  
 WIDTH 2.00 IN.  
 LENGTH 29.94 IN.  
 CROSS-SECTION \_\_\_\_\_  
 WEIGHT 1,370 GRAMS  
 RINGS PER INCH 8  
 SAP 100 %  
 SUMMERWOOD 30 %  
 SEASONING GREEN  
 MOISTURE 61.4 %  
 TESTED AT 75°F TEMP. 64 % R.H.  
 KIND OF FAILURE COMPRESSION  
FOLLOWED BY SPLINTERING  
TENSION.  
 REMARKS \_\_\_\_\_

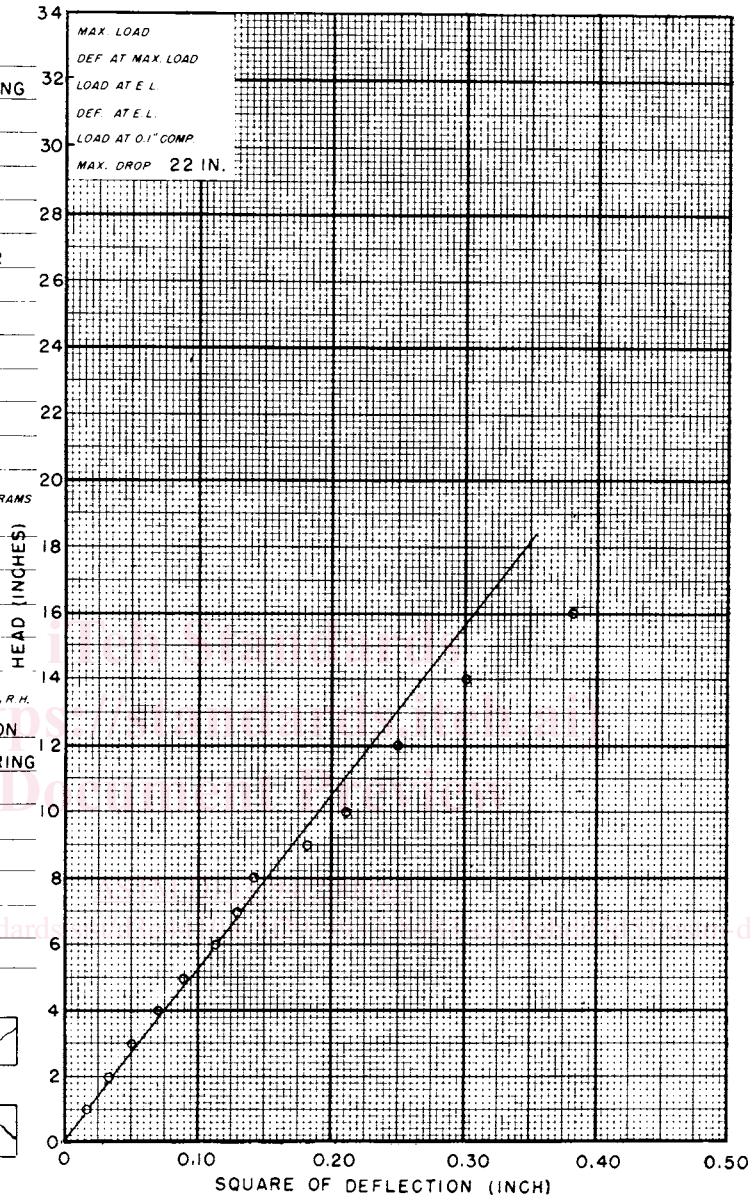

FIG. 13 Sample Data Sheet for Impact Bending Test

NOTE 10—See Fig. 18 for a sample compression-perpendicular-to-grain data sheet form.

12.5.2 Deflection readings shall be taken to 0.0001 in. (0.002 mm).

12.6 Weight and Moisture Content—The specimen shall be weighed immediately before test, and after test a moisture section approximately 1 in. (25 mm) in length shall be cut adjacent to the part under load (see 21.1 and 22.1).

### 13. Hardness

13.1 Size of Specimens—The hardness tests shall be made on 2 by 2 by 6 in. (50 by 50 by 150 mm) specimens. The actual cross-sectional dimensions and length shall be measured (see 22.2).

**IMPACT BENDING**

L-315 (Ship. No.)      F-12 (Stock No.)      Station **MADISON**      Date **Aug. 20, 1914**      101151 (Lab. No.)

1 (Piece No.)      C (Mark)      Species **Douglas Fir**      Grade **Clear**      Seasoning **Green**      124 (Project No.)

Rings **8**      Sap **100**      % Summerwood **30**      % Moisture **61.4**      %

Hammer **50**      lbs. Span **28 in.**      Length **29.94 in.**      Height **2.00 in.**      Width **2.00 in.**      Weight **1370 g.**

Drop No.	Head	Dev.	Drop <sup>2</sup>	Dev.	Drop No.	Head	Dev.	Drop <sup>2</sup>	Dev.	Sp. Gr. (ad test)
1	1.0	0.13	0.017		11	12.0	0.50	0.250		0.698
2	2.0	0.18	0.032		12	14.0	0.55	0.302		0.432
3	3.0	0.22	0.048		13	16.0	0.62	0.384		F. S. at E. L., 10.610
4	4.0	0.26	0.068		14	18.0	0.67	0.593		M. of E., 1776
5	5.0	0.30	0.090		15					E. Resil., 3.51
6	6.0	0.34	0.116		16					Max. Drop, 22 in.
7	7.0	0.36	0.130		17					S, 0.010
8	8.0	0.38	0.144		18					H, 7.88
9	9.0	0.43	0.185		19					Δ, 0.39
10	10.0	0.46	0.212		20					

Failure: Compression Followed by Splintering Tension.

FIG. 14 Sample Data and Computation Card for Impact Bending Test

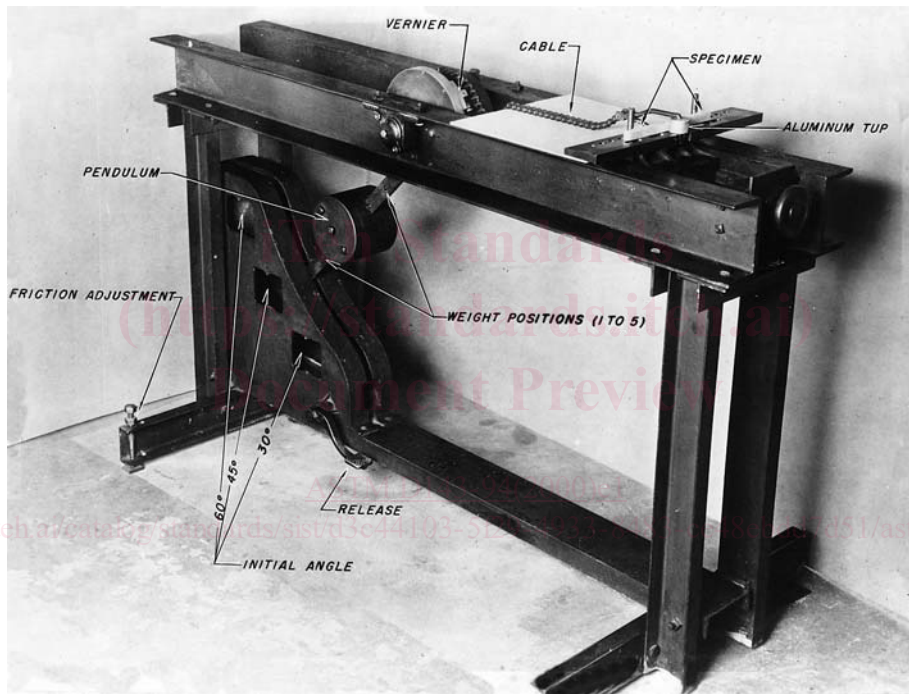

FIG. 15 Toughness Test Assembly

13.2 Procedure—Use the modified ball test with a “ball” 0.444 in. (11.3 mm) in diameter for determining hardness (Fig. 19). The projected area of the ball on the test specimen is 1 cm<sup>2</sup>. Record the load at which the ball has penetrated to one half its diameter, as determined by an electric circuit indicator or by the tightening of the collar against the specimen.

13.3 Number of Penetrations—Two penetrations shall be made on a tangential surface, two on a radial surface, and one on each end. The choice between the two radial and between the two tangential surfaces shall be such as to give a fair average of the piece. The penetrations shall be far enough from the edge to prevent splitting or chipping (Note 11).

NOTE 11—See Fig. 20 for a sample data and computation sheet for hardness test.

13.4 Speed of Testing—The load shall be applied continuously throughout the test at a rate of motion of the movable crosshead of 0.25 in. (6 mm/min) (see 22.3).

13.5 Weight and Moisture Content—The specimen shall be weighed immediately before the test, and after the test a moisture section approximately 1 in. (25 mm) in length shall be cut (see 21.1 and 22.1).

**14. Shear Parallel to Grain**

14.1 This section describes one method of making the shear-parallel-to-grain test that has been extensively used and found satisfactory.

14.2 Size of Specimens—The shear-parallel-to-grain tests shall be made on a 2 by 2 by 2-1/2 in. (50 by 50 by 63 mm)