**Technical drawings — General principles of
presentation —**

Part 22:

Basic conventions and applications for leader
lines and reference lines

iTeh STANDARD PREVIEW
(standards.iteh.ai)

Dessins techniques — Principes généraux de représentation —

*Partie 22: Conventions de base et applications pour les traits de rappel de
cote et traits de référence*

ISO 128-22:1999

<https://standards.iteh.ai/catalog/standards/sist/225fb29c-8da9-432d-a5b9-9cfc021ac313/iso-128-22-1999>



Foreword

ISO (the International Organization for Standardization) is a worldwide federation of national standards bodies (ISO member bodies). The work of preparing International Standards is normally carried out through ISO technical committees. Each member body interested in a subject for which a technical committee has been established has the right to be represented on that committee. International organizations, governmental and non-governmental, in liaison with ISO, also take part in the work. ISO collaborates closely with the International Electrotechnical Commission (IEC) in all matters of electrotechnical standardization.

International Standards are drafted in accordance with the rules given in the ISO/IEC Directives, Part 3.

Draft International Standards adopted by the technical committees are circulated to the member bodies for voting. Publication as an International Standard requires approval by at least 75% of the member bodies casting a vote.

International Standard ISO 128-22 was prepared by Technical Committee ISO/TC 10, *Technical drawings, product definition and related documentation*, Subcommittee SC 1, *Basic conventions*.

ISO 128 consists of the following parts, under the general title *Technical drawings — General principles of presentation*:

- Part 20: *Basic conventions for lines*
- Part 21: *Preparation of lines by CAD systems*
- Part 22: *Basic conventions and applications for leader lines and reference lines*
- Part 23: *Lines on construction drawings* [ISO 128-22:1999](https://standards.iteh.ai/catalog/standards/sist/225fb29c-8da9-432d-a5b9-3/iso-128-22-1999)
- Part 24: *Lines on mechanical engineering drawings* <https://standards.iteh.ai/catalog/standards/sist/225fb29c-8da9-432d-a5b9-3/iso-128-22-1999>
- Part 25: *Lines on shipbuilding drawings*
- Part 30: *Basic conventions for views*
- Part 31: *Additional conventions for views*
- Part 40: *Basic conventions for cuts and sections*
- Part 41: *Cuts and sections for mechanical engineering drawings*
- Part 50: *Basic conventions for representing areas on cuts and sections*
- Part 60: *Additional conventions for cuts and sections*

Annex B forms an integral part of this part of ISO 128. Annex A is for information only.

© ISO 1999

All rights reserved. Unless otherwise specified, no part of this publication may be reproduced or utilized in any form or by any means, electronic or mechanical, including photocopying and microfilm, without permission in writing from the publisher.

International Organization for Standardization
Case postale 56 • CH-1211 Genève 20 • Switzerland
Internet iso@iso.ch

Printed in Switzerland

Technical drawings — General principles of presentation —

Part 22:

Basic conventions and applications for leader lines and reference lines

1 Scope

This part of ISO 128 specifies general rules on the presentation of leader and reference lines and their components as well as on the arrangement of instructions on or at leader lines in all kinds of technical documents.

2 Normative reference

The following normative document contains provisions which, through reference in this text, constitute provisions of this part of ISO 128. For dated references, subsequent amendments to, or revisions of, any of these publications do not apply. However, parties to agreements based on this part of ISO 128 are encouraged to investigate the possibility of applying the most recent edition of the normative document indicated below. For undated references, the latest edition of the normative document referred to applies. Members of ISO and IEC maintain registers of currently valid International Standards.

ISO 128-20:1996, *Technical drawings — General principles of presentation — Part 20: Basic conventions for lines*.
<https://standards.iteh.ai/catalog/standards/sist/225fb29c-8da9-432d-a5b9-9cf021ac313/iso-128-22-1999>

3 Terms and definitions

For the purposes of this part of ISO 128, the following terms and definitions apply.

3.1

leader line

continuous narrow line which establishes the connection between the features of a graphical representation and additional alphanumeric and/or written instructions (notes, technical requirements, item references, etc.) in an unambiguous manner

3.2

reference line

continuous narrow line connecting with the leader line horizontally or vertically and on or at which the additional instructions are indicated

4 Presentation of leader lines

Leader lines are executed as continuous narrow lines in accordance with ISO 128-20. They are drawn preferably at an angle to the relevant representation and/or the frame limiting the drawing sheet, and not parallel to adjacent lines, e.g. hatching lines. The inclination to the relevant lines shall be $> 15^\circ$. See Figures 1 to 13.

Leader lines may be drawn with sharp kinks (see Figure 5), and two or more leader lines may be joined up (see Figures 2, 5, 7, 8 and 11). They should not cross other leader lines, reference lines or indications, such as graphical symbols or dimensional values.

Leader lines shall terminate at the end which touches the features as follows:

- with a closed and filled or a closed arrowhead (included angle 15°) if the leader line ends at lines which represent outlines or edges of parts, pipings or cables in plans, charts or diagrams; arrowheads are also drawn at crossing points of these lines with other lines, e.g. lines of symmetry (see the examples given in Figures 1 to 7);

NOTE If several parallel lines have to be designated, oblique strokes instead of arrowheads are permitted (see IEC 61082-1). See the example given in Figure 8.

- with a dot ($d = 5 \times$ line width) if the leader line ends within the outlines of an object (see the examples given in Figures 9 to 11);
- without any termination if the leader line ends at another line, e.g. dimension line or line of symmetry (see the examples given in Figures 12 and 13).

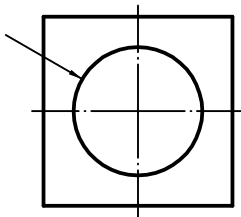

Figure 1

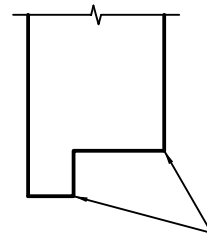

Figure 2

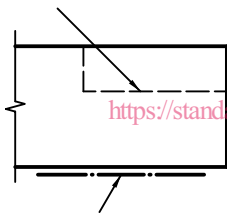

Figure 3

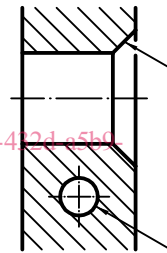

Figure 4

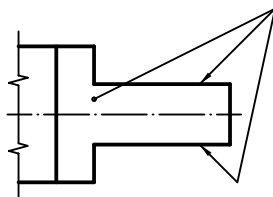

Figure 5

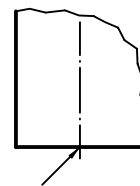

Figure 6

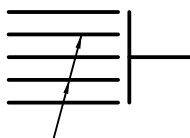

Figure 7

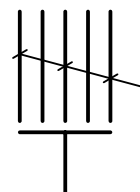

Figure 8

iTeh STANDARD PREVIEW
(standards.iteh.ai)

ISO 128-22:1999

<https://standards.iteh.ai/catalog/standards/sist/225fb29c-8da9-4424-a5b9-9cf021ac313/iso-128-22-1999>

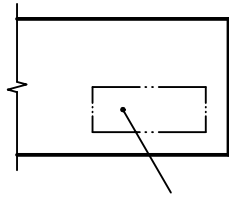

Figure 9

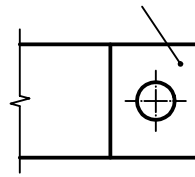

Figure 10



Figure 11

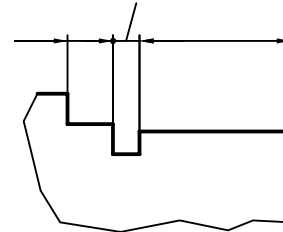

Figure 12

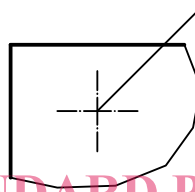

Figure 13

iTeh STANDARD PREVIEW
(standards.iteh.ai)

5 Presentation of reference lines

ISO 128-22:1999

Reference lines are executed as continuous narrow lines in accordance with ISO 128-20. A reference line may be added to each leader line. It is drawn in one of the reading directions of the drawing.

The reference line shall be drawn

- either with a fixed length, i.e. $20 \times$ line width of the reference line (see the examples given in Figures 15 and 16),
- or with a length adapted to the length of the indicated instructions (see the examples given in Figures 14, 17, 21 and 22).

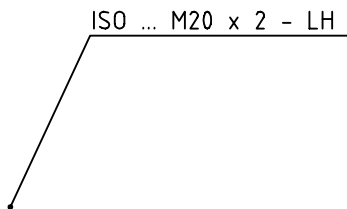

Figure 14

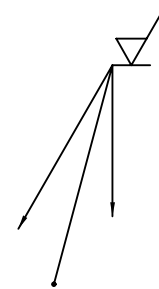

Figure 15

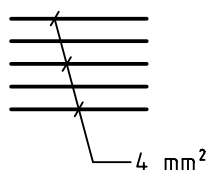

Figure 16

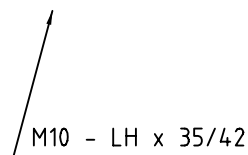

Figure 17

In particular cases of application the reference line has to be drawn (see the example given in Figure 15).

However, the reference line may be omitted, if the leader line is drawn in one of the reading directions of the drawing and if the indicated instructions are written in the same direction (see the example given in Figure 18), and in all other cases in which this line is not applicable (see the examples given in Figures 12, 19 and 20).

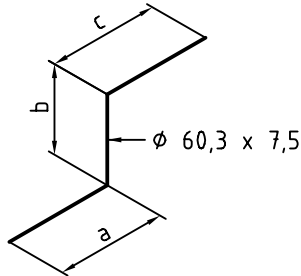

Figure 18

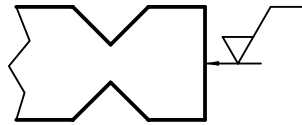

Figure 19

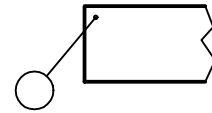

Figure 20

6 Indication of instructions

The instructions belonging to the leader lines shall be indicated as follows:

- preferably above the reference line (see the example given in Figures 14, 17, 21 and 22 and in annex A);
- centrally behind the leader or reference line (see the example given in Figure 16 and 18); or
- around, within or behind graphical symbols according to the valid International Standards (see the examples given in Figures 21 and 22 and in annex A).

Taking into account the requirements for microcopying in ISO 6428, the instructions should be written at a distance of twice the line width of the reference line above or below the reference line. They should not be drawn within the reference line and they should not touch it.

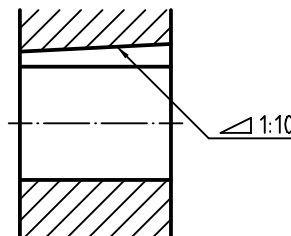

Figure 21

If individual layers or assembled parts of an object are designated with one leader line, the order of the indications shall correspond with the order of the layers or the parts (see the example given in Figure 22).

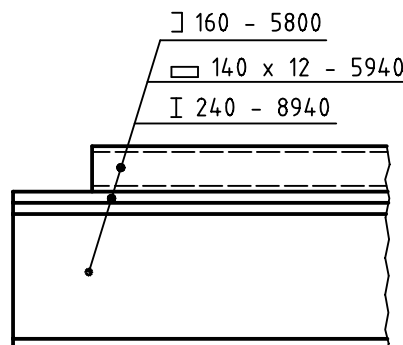
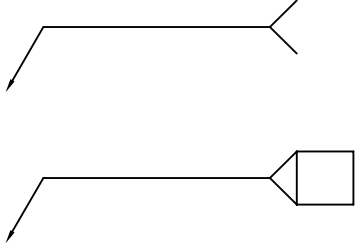

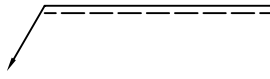
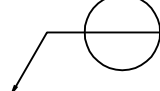
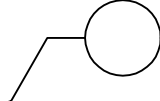
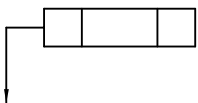

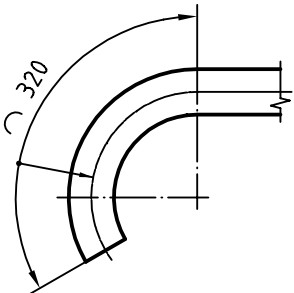
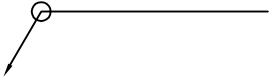

Figure 22

Annex A (informative)

Graphical supplements contained in other International Standards

No.	Graphical supplement	International Standard	Application
1		ISO 2553	Indication of further information concerning welds, e.g. the number of the welding process
2		ISO 2553	Designation of a field or site weld
3		ISO 2553	Identification of the location of a weld
4		ISO 5459	Datum target frame
5		ISO 6433	Indication of item references (ISO 6433 does not specify only this method)
6		ISO 1101	Frame used for geometrical tolerance requirements
7		ISO 1101	Indication of several toleranced features
8		ISO 129	Indication of dimensions of arc lengths

No.	Graphical supplement	International Standard	Application
ga		<p>ISO 1101:—, Table 2</p> <p>ISO 1101:—, 9.1</p> <p>ISO 1302:1992, 4.6</p> <p>ISO 1302:1992, clause D.4</p> <p>ISO 2553:1992, 7.1</p> <p>ISO 10135:1994, 6.2</p> <p>ISO 10135:1994, 6.4</p> <p>ISO 13715:1994, 4.2</p>	<p>This sign (circle) has the following meanings in the International Standards mentioned below:</p> <ul style="list-style-type: none"> — geometrical (profile) tolerance all around the profile — profile tolerance of the entire outline of the cross section — surface texture on all surfaces around a part — roughness on all surfaces — a peripheral weld all around a part — features, e.g. burr, all around a part — machining allowance which applies to all surfaces — the same state of corner all around a part

^a The sign "circle" is used for different meanings in the above-mentioned International Standard, e. g. "all around (profile)" (ISO 1101) and "all surfaces/corners" (ISO 1302/ISO 13715). This unfortunate situation should be replaced by an unambiguous solution for all cases of application (see Annex B). It should be taken into account that no sign is needed if any requirement is to be valid for all surfaces/corners of a part. In this case the generally valid requirement should be specified by a note (an entry) near the view or cut (section) of the part, within or near the title block or in the space provided for general notes.

ISO 128-22:1999

<https://standards.iteh.ai/catalog/standards/sist/225fb29c-8da9-432d-a5b9-9cfc021ac313/iso-128-22-1999>

Annex B (normative)

Meaning and application of the graphical supplement "circle" for leader lines

The same required characteristic on a number of surfaces or corners of a part connected to each other may be indicated only once if a circle ($d = 8 \times$ width of the leader line) is drawn at the connecting point of the leader line and the reference line, see Figures B.1 to B.3. This means that the same requirements apply to all surfaces or corners around the contour or profile of the represented part.

The "circle" sign shall not be used if either or both of the following occur:

- a) the indications are ambiguous,
- b) the indication concerns all surfaces or corners of a part.

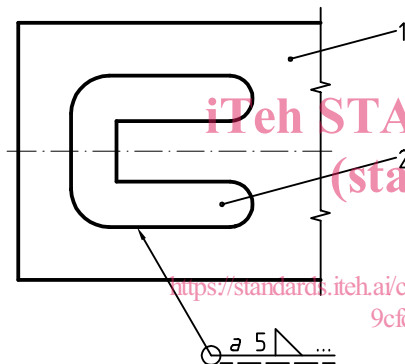

Figure B.1

iTeh STANDARD PREVIEW
(standards.iteh.ai)

ISO 128-22:1999

<https://standards.iteh.ai/catalog/standards/sist/225fb29c-8da9-432d-a5b9-9cf021ac313/iso-128-22-1999>

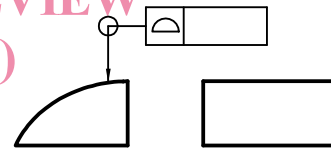

Figure B.2

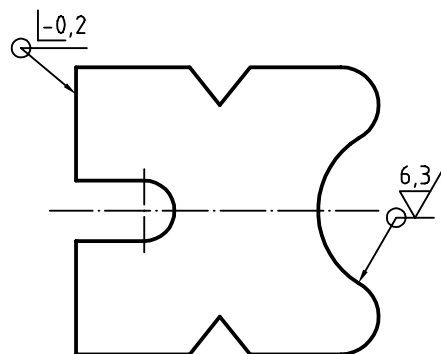

Figure B.3