**Technical drawings — General principles of
presentation —**

Part 40:

Basic conventions for cuts and sections

*Dessins techniques — Principes généraux de représentation —
Partie 40: Conventions de base pour les coupes et les sections*

**iTeh STANDARD PREVIEW
(standards.iteh.ai)**

ISO 128-40:2001

<https://standards.iteh.ai/catalog/standards/sist/20f95970-cb2e-423e-8c80-293a719df37/iso-128-40-2001>



Reference number
ISO 128-40:2001(E)

© ISO 2001

PDF disclaimer

This PDF file may contain embedded typefaces. In accordance with Adobe's licensing policy, this file may be printed or viewed but shall not be edited unless the typefaces which are embedded are licensed to and installed on the computer performing the editing. In downloading this file, parties accept therein the responsibility of not infringing Adobe's licensing policy. The ISO Central Secretariat accepts no liability in this area.

Adobe is a trademark of Adobe Systems Incorporated.

Details of the software products used to create this PDF file can be found in the General Info relative to the file; the PDF-creation parameters were optimized for printing. Every care has been taken to ensure that the file is suitable for use by ISO member bodies. In the unlikely event that a problem relating to it is found, please inform the Central Secretariat at the address given below.

iTeh STANDARD PREVIEW
(standards.iteh.ai)

ISO 128-40:2001

<https://standards.iteh.ai/catalog/standards/sist/20f95970-cb2e-423e-8c80-293a719df37/iso-128-40-2001>

© ISO 2001

All rights reserved. Unless otherwise specified, no part of this publication may be reproduced or utilized in any form or by any means, electronic or mechanical, including photocopying and microfilm, without permission in writing from either ISO at the address below or ISO's member body in the country of the requester.

ISO copyright office
Case postale 56 • CH-1211 Geneva 20
Tel. + 41 22 749 01 11
Fax + 41 22 749 09 47
E-mail copyright@iso.ch
Web www.iso.ch

Printed in Switzerland

Foreword

ISO (the International Organization for Standardization) is a worldwide federation of national standards bodies (ISO member bodies). The work of preparing International Standards is normally carried out through ISO technical committees. Each member body interested in a subject for which a technical committee has been established has the right to be represented on that committee. International organizations, governmental and non-governmental, in liaison with ISO, also take part in the work. ISO collaborates closely with the International Electrotechnical Commission (IEC) on all matters of electrotechnical standardization.

International Standards are drafted in accordance with the rules given in the ISO/IEC Directives, Part 3.

Draft International Standards adopted by the technical committees are circulated to the member bodies for voting. Publication as an International Standard requires approval by at least 75 % of the member bodies casting a vote.

Attention is drawn to the possibility that some of the elements of this part of ISO 128 may be the subject of patent rights. ISO shall not be held responsible for identifying any or all such patent rights.

International Standard ISO 128-40 was prepared by Technical Committee ISO/TC 10, *Technical product documentation*, Subcommittee SC 1, *Basic conventions*.

This first edition is based on ISO 128:1982, clause 2 of which it cancels and replaces.

ISO 128 consists of the following parts, under the general title *Technical drawings — General principles of presentation*:

- *Part 1: Introduction and index*
- *Part 20: Basic conventions for lines*
- *Part 21: Preparation of lines by CAD systems*
- *Part 22: Basic conventions and applications for leader lines and reference lines*
- *Part 23: Lines on construction drawings*
- *Part 24: Lines on mechanical engineering drawings*
- *Part 25: Lines on shipbuilding drawings*
- *Part 30: Basic conventions for views*
- *Part 34: Views on mechanical engineering drawings*
- *Part 40: Basic conventions for cuts and sections*
- *Part 44: Sections on mechanical engineering drawings*
- *Part 50: Basic conventions for representing areas on cuts and sections*

Annex A forms a normative part of this part of ISO 128.

iTeh STANDARD PREVIEW
(standards.iteh.ai)

ISO 128-40:2001

<https://standards.iteh.ai/catalog/standards/sist/20f95970-cb2e-423e-8c80-293a719df37/iso-128-40-2001>

Technical drawings — General principles of presentation —

Part 40:

Basic conventions for cuts and sections

1 Scope

This part of ISO 128 specifies the general principles for presenting cuts and sections applicable to all kinds of technical drawings (mechanical, electrical, architectural, civil engineering, etc.) following the orthographic projection methods specified in ISO 5456-2. For areas on cuts and sections, representation is according to ISO 128-50.

Attention has also been given in this part of ISO 128 to the requirements of reproduction, including microcopying in accordance with ISO 6428.

2 Normative references

The following normative documents contain provisions which, through reference in this text, constitute provisions of this part of ISO 128. For dated references, subsequent amendments to, or revisions of, any of these publications do not apply. However, parties to agreements based on this part of ISO 128 are encouraged to investigate the possibility of applying the most recent editions of the normative documents indicated below. For undated references, the latest edition of the normative document referred to applies. Members of ISO and IEC maintain registers of currently valid International Standards.

ISO 128-23:1999, *Technical drawings — General principles of presentation — Part 23: Lines on construction drawings*

ISO 128-24:1999, *Technical drawings — General principles of presentation — Part 24: Lines on mechanical engineering drawings.*

ISO 128-30, *Technical drawings — General principles of presentation — Part 30: Basic conventions for views.*

ISO 128-50, *Technical drawings — General principles of presentation — Part 50: Basic conventions for representing areas on cuts and sections.*

ISO 3098-0, *Technical product documentation — Lettering — Part 0: General requirements.*

ISO 5456-2, *Technical drawings — Projection methods — Part 2: Orthographic representations.*

ISO 6428, *Technical drawings — Requirements for microcopying.*

ISO 10209-1, *Technical product documentation — Vocabulary — Part 1: Terms relating to technical drawings: general and types of drawings.*

ISO 10209-2, *Technical product documentation — Vocabulary — Part 2: Terms relating to projection methods.*

ISO 81714-1, *Design of graphical symbols for use in the technical documentation of products — Part 1: Basic rules.*

3 Terms and definitions

For the purposes of this part of ISO 128, the terms and definitions given in ISO 10209-1 and ISO 10209-2, and the following, apply.

- 3.1**
cutting plane
imaginary plane at which the object represented is cut through
- 3.2**
cutting line
line indicating the position of a cutting plane, or the sectioning axis in the case of two or more cutting planes
- 3.3**
cut
sectional view
section showing, in addition, outlines beyond the cutting plane

NOTE This is an extract from ISO 10209-1:1992 (term 2.2). However, the usage of the terms “cut” and “section” differs between the mechanical engineering and construction fields. While “cut” is generally used in the construction field, “section” is generally used in the mechanical engineering field, regardless of the definitions in 3.3 or 3.4.

- 3.4**
section
representation showing only the outlines of an object lying in one or more cutting planes

NOTE This is an extract from ISO 10209-1:1992 (term 2.9). However, the usage of the terms “cut” and “section” differs between the mechanical engineering and construction fields. While “cut” is generally used in the construction field, “section” is generally used in the mechanical engineering field, regardless of the definitions in 3.3 or 3.4.

- 3.5**
half cut/half section
representation of a symmetrical object which, divided by the centre line, is drawn half in view and half in cut or section
- 3.6**
local cut/local section
representation in which only a part of an object is drawn in cut or section

4 General

The general rules for the arrangement of views (see ISO 128-30) apply equally when drawing cuts and sections.

Each cut and section shall be given clear identification with twice the same capital letter, once at each of the reference arrows (drawn with a continuous wide line of type 01.2.8 according to ISO 128-24:1999 or 01.2.8 according to ISO 128-23:1999) indicating the direction of viewing for the relevant cut and section, at the ends of the cutting line (see annex A). This identification should be positioned for reading from the bottom of the drawing. The 30° or 90° cut and section arrow is defined in annex A, as is the lettering height of the identification.

The designated cut and section may be located irrespective of the view in which the cutting plane is taken. The identification of the referenced cuts and sections shall be placed immediately above the relevant representation.

Representation of areas on cuts and sections is covered by ISO 128-50.

The position of the cutting plane(s) shall be indicated by means of a long-dashed dotted wide line (cutting line) of the type 04.2 according to ISO 128-24:1999 or 04.2.1 according to ISO 128-23:1999. A straight cutting plane shall be drawn to a suitable length for legibility (see Figure 1).

If the cutting plane changes its direction, the cutting line should only be drawn at the ends of the cutting plane, where the cutting plane changes direction (see Figure 2).

The cutting line may be drawn to its full length (with a long-dashed dotted narrow line of the type 04.1 according to ISO 128-24:1999 or 04.1 according to ISO 128-23:1999) if necessary for its legibility.

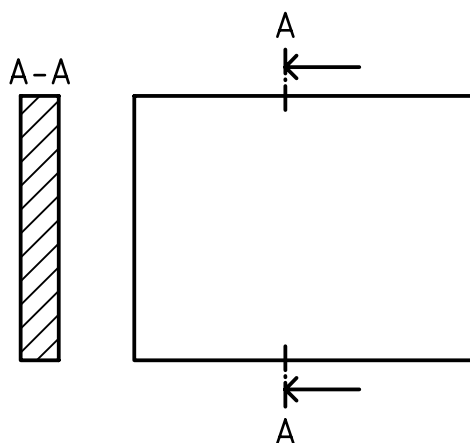

Figure 1 — Example from construction field
 iTeh STANDARD PREVIEW
 (standards.iteh.ai)

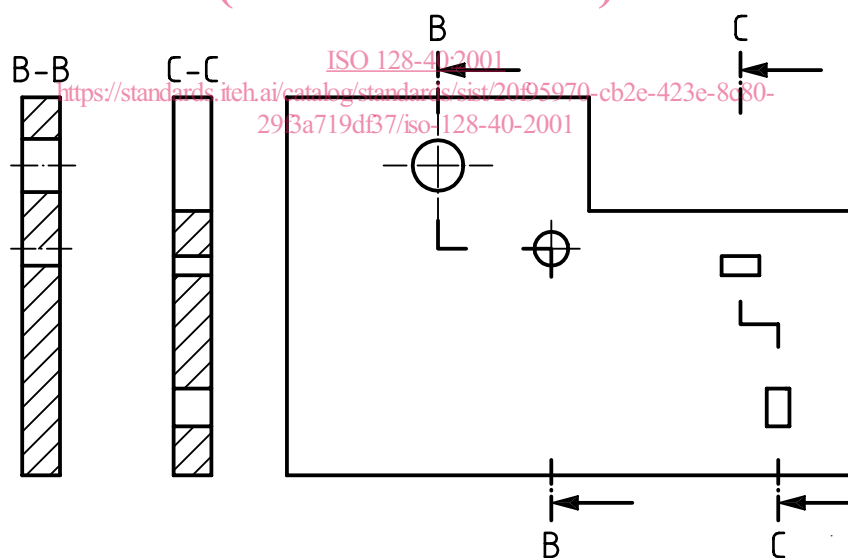

Figure 2 — Example from mechanical engineering field

5 Sections revolved in the relevant view

If unambiguous, a section can be revolved in the relevant view. If this is done, the outline of the section shall be drawn with continuous narrow lines of the type 01.1.16 according to ISO 128-24:1999 or 01.1.11 according to ISO 128-23:1999; further identification is then not necessary [see Figure 3 a) and b)].

NOTE The rotational direction of the section in the view is unknown.

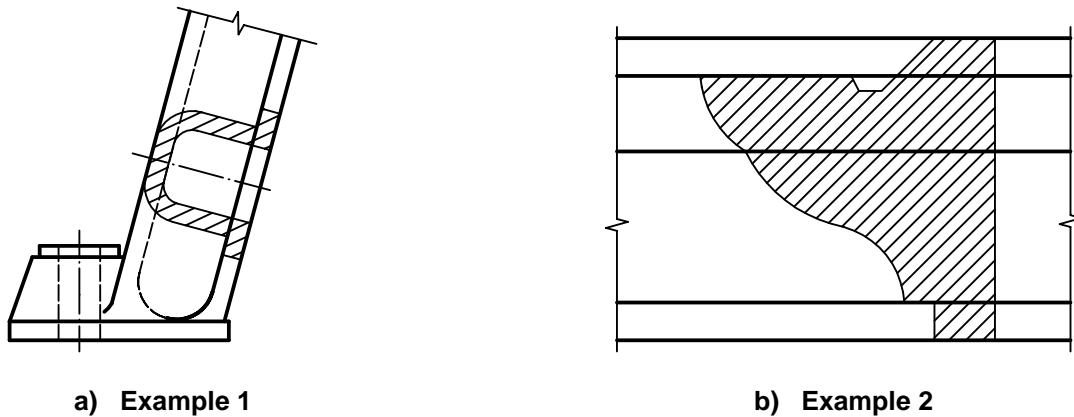

Figure 3 — Sections revolved in relevant view

6 Cuts/sections of symmetrical parts

Symmetrical parts may be drawn half in view and half in cut/section (see Figure 4).

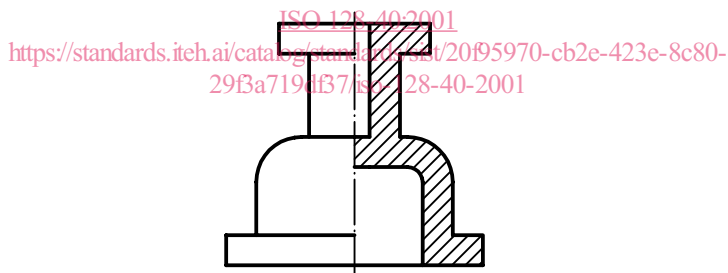

Figure 4 — Half in section of symmetrical part

7 Local cuts/sections

A local cut/section may be drawn if a complete or a half cut/section is unnecessary. The local break shall be shown by a continuous narrow line with zigzags or freehand of type 01.1.19 or 01.1.18 according to ISO 128-24:1999 or 01.1.14 according to ISO 128-23:1999. See Figure 5.

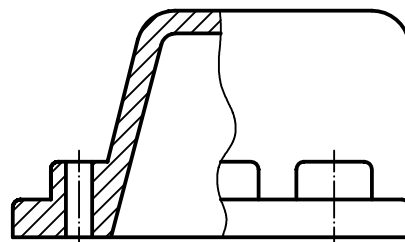

Figure 5 — Local cut

Annex A (normative)

Graphical symbols

A.1 General

In order to harmonize the sizes of the graphical symbols specified in this part of ISO 128 with those of the other inscriptions on the drawing (dimensions, tolerances, etc.), the rules given in ISO 81714-1 shall apply.

The cut and section identification lettering height, h , shall be larger than the normal lettering on the technical drawing by a factor of $\sqrt{2}$.

Within Figures A.1 and A.2, lettering type B, vertical, according to ISO 3098-0, applies. Other lettering types are also permitted.

A.2 Cut and section arrows

See Figure A.1 for 30° cut and section arrows, and Figure A.2 for 90° cut and section arrows.

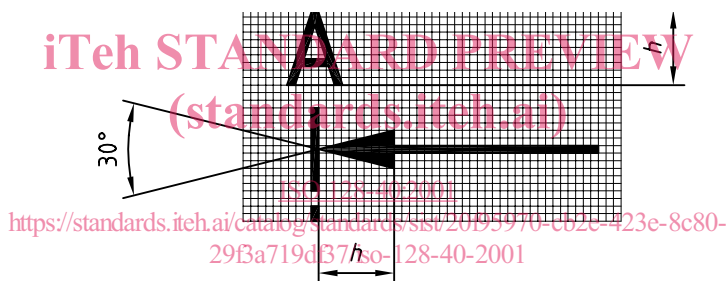

Figure A.1

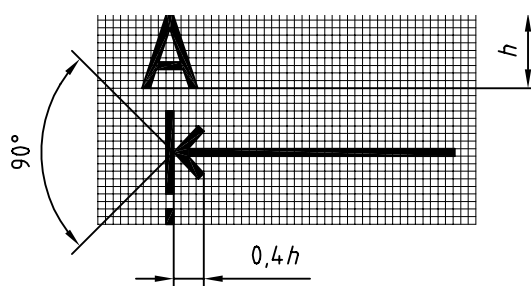

Figure A.2