



SLOVENSKI STANDARD
SIST-TP CEN/TR 16815:2016

01-januar-2016

CleANopen - Aplikacijski profil za uporabo na komunalnih vozilih (za zbiranje odpadkov)

CleANopen - Application profile for municipal vehicles

CleANopen - Anwendungsprofil für Kommunalfahrzeuge

CANopen - Profil d'application aux véhicules municipaux

ITeH STANDARD PREVIEW
(standards.iteh.ai)

Ta slovenski standard je istoveten z: CEN/TR 16815:2015

SIST-TP CEN/TR 16815:2016
<https://standards.iteh.ai/catalog/standards/sist/e6e0cd59-2424-4d81-9e59-44f752894de2/sist-tp-cen-tr-16815-2016>

ICS:

35.240.60	Uporabniške rešitve IT v transportu in trgovini	IT applications in transport and trade
43.160	Vozila za posebne namene	Special purpose vehicles

SIST-TP CEN/TR 16815:2016

en,fr,de

iTeh STANDARD PREVIEW
(standards.iteh.ai)

[SIST-TP CEN/TR 16815:2016](#)

<https://standards.iteh.ai/catalog/standards/sist/e6e0cd59-2424-4d81-9e59-44f752894de2/sist-tp-cen-tr-16815-2016>

TECHNICAL REPORT

CEN/TR 16815

RAPPORT TECHNIQUE

TECHNISCHER BERICHT

November 2015

ICS 35.240.60; 43.040.15; 43.160

English Version

CleANopen - Application profile for municipal vehicles

CleANopen - Profil d'application aux véhicules
municipauxCleANopen - Anwendungsprofil für
Kommunalfahrzeuge

This Technical Report was approved by CEN on 23 February 2015. It has been drawn up by the Technical Committee CEN/TC 183.

CEN members are the national standards bodies of Austria, Belgium, Bulgaria, Croatia, Cyprus, Czech Republic, Denmark, Estonia, Finland, Former Yugoslav Republic of Macedonia, France, Germany, Greece, Hungary, Iceland, Ireland, Italy, Latvia, Lithuania, Luxembourg, Malta, Netherlands, Norway, Poland, Portugal, Romania, Slovakia, Slovenia, Spain, Sweden, Switzerland, Turkey and United Kingdom.

iTeh STANDARD PREVIEW
(standards.iteh.ai)

[SIST-TP CEN/TR 16815:2016](https://standards.iteh.ai/catalog/standards/sist/e6e0cd59-2424-4d81-9e59-44f752894de2/sist-tp-cen-tr-16815-2016)

<https://standards.iteh.ai/catalog/standards/sist/e6e0cd59-2424-4d81-9e59-44f752894de2/sist-tp-cen-tr-16815-2016>



EUROPEAN COMMITTEE FOR STANDARDIZATION
COMITÉ EUROPÉEN DE NORMALISATION
EUROPÄISCHES KOMITEE FÜR NORMUNG

CEN-CENELEC Management Centre: Avenue Marnix 17, B-1000 Brussels

Contents	Page
European foreword.....	3
1 Scope	4
2 Normative references	4
3 Terms and definitions	4
4 Acronyms	5
5 Abbreviations	6
6 General architecture	6
7 Physical layer specification	13
8 Error handling	14
9 Data type specification	15
10 Object dictionary entries	15
11 Pre-defined TPDO communication	52
12 Manufacturer-specific TPDOs	493
13 Pre-defined RPDO communication	494
14 Manufacturer-specific RPDOs	902
15 Pre-defined additional SDO communication	902
16 Object dictionary	951
Annex A (normative) Manufacturer-specific TPDOs for unit-specific use	1094
Annex B (normative) Manufacturer-specific RPDOs for unit-specific use	1100
Annex C (informative) Measurement process	1106
Bibliography	1109

European foreword

This document (CEN/TR 16815:2015) has been prepared by Technical Committee CEN/TC 183 “Waste management”, the secretariat of which is held by DIN.

Attention is drawn to the possibility that some of the elements of this document may be the subject of patent rights. CEN [and/or CENELEC] shall not be held responsible for identifying any or all such patent rights.

This document is based on the version 2.0 of the CiA 422 specification series describes the embedded body control network of refuse collecting vehicles (RCV). It specifies the CANopen (EN 50325-4) communication interfaces and the application functionality of several functional elements (virtual devices). It does not specify CANopen devices.

This document is structured as follows:

- the 1st part (Clauses 3 to 9) contains general definitions and describes the functionality of the virtual devices as well as the CANopen physical layer requirements and recommendations.
- the 2nd part (Clause 10) provides a detailed overview of communication and application parameters supported by the different virtual devices. Virtual devices include the body controller, and the change container, compaction, lifter, identification, measuring A and B, bin classification, washing, truck gateway as well as GPS units. Also a monitoring device is described
- the 3rd part (Clauses 11 to 15) and its sub-parts specify the pre-defined Process Data Objects (PDO) and the additional pre-defined SDOs. The pre-defined Transmit-PDOs for all virtual devices are specified in Clause 11. This includes the PDO communication parameter set as well as the PDO mapping parameter set. The corresponding Receive-PDOs are specified in Clause 13. The SDO communication between bin classification units and measuring units is specified in Clause 15.
- the 4th part (Clause 16) specifies the application parameters. This covers the process data (mainly mapped into PDOs), configuration data, and diagnostic information (both mainly transmitted by SDO communication services). In this clause are defined parameter pools for the measuring units, and the data read as well as write for identification units. Other introduced parameters include support profile version, extended status for measuring units and measuring ident controllers.

CEN/TR 16815:2015 (E)**1 Scope**

This Technical Report provides a set of CANopen application profile specifications that describes the *CleANopen* embedded body control network of municipal vehicles, e.g. refuse collecting trucks.

It specifies the CANopen communication interfaces and the application functionality of several functional elements (virtual devices).

It does not specify CANopen devices.

The *CleANopen* application profile specifications consist of several parts dealing with the following:

- general definitions;
- functionality of the virtual devices;
- pre-defined PDOs and SDOs;
- application objects.

2 Normative references

The following documents, in whole or in part, are normatively referenced in this document and are indispensable for its application. For dated references, only the edition cited applies. For undated references, the latest edition of the referenced document (including any amendments) applies.

ISO 639-1, Codes for the representation of names of languages — Part 1: Alpha-2 code

ISO/IEC 646, Information technology — ISO 7-bit coded character set for information interchange

ISO 11898-2, Road vehicles — Controller area network (CAN) — High-speed medium access unit

SAE J1939-71, Recommended practice for a serial control and communication network — Vehicle application layer

3 Terms and definitions

For the purposes of this document, the following terms and definitions apply.

3.1***CleANopen* unit**

virtual device that provides functional elements specified in this application profile

3.2**functional element**

atomic application function

3.3**virtual device**

part of the logical device as defined in [CiA301]

3.4**left side**

when viewing forward, the left side

3.5**pitch**

angle from the front to the back of the vehicle (see Figure 1)

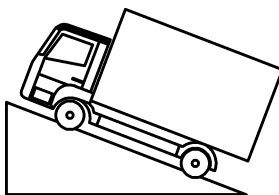

Figure 1

3.6**right side**

when viewing forward, the right side

3.7**roll**

angle from the left to the right side of the vehicle (see Figure 2)

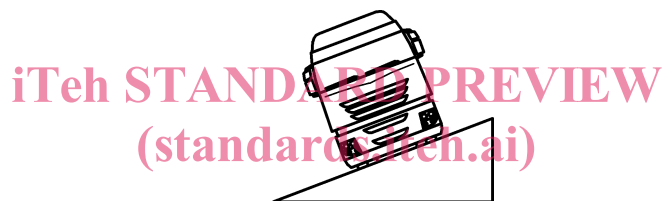

[SIST-TP CEN/TR 16815:2016](https://standards.iteh.ai/catalog/standards/sist/e6e0cd59-2424-4d81-9e59-44f752894de2/sist-tp-cen-tr-16815-2016)

<https://standards.iteh.ai/catalog/standards/sist/e6e0cd59-2424-4d81-9e59-44f752894de2/sist-tp-cen-tr-16815-2016>

Figure 2

4 Acronyms

The acronyms given in documents CiA301, CiA413 series and SAEJ1939 apply for this standard, too.

BCU	Bin classification unit
BC	Body controller
MIC	Measuring ident controller
CAN	Controller area network
CCU	Change container unit
COB	Communication object
COB-ID	COB identifier
CSDO	Client SDO
CU	Compaction unit
GPS	Global positioning system

CEN/TR 16815:2015 (E)

GPSU	GPS unit
IDU	Identification unit
IVN	In-vehicle network
LSB	Least significant bit
LU	Lifter unit
MSB	Most significant bit
MU	Measuring unit
SSDO	Server SDO
TGU	Truck gateway unit
WU	Washing unit

5 Abbreviations

Acc.	Access
Cat.	Category
const	constant
ro	read-only
rw	read/write

iTeh STANDARD PREVIEW
(standards.iteh.ai)

[SIST-TP CEN/TR 16815:2016
https://standards.iteh.ai/catalog/standards/sist/e6e0cd59-2424-4d81-9e59-44f752894de2/sist-tp-cen-tr-16815-2016](https://standards.iteh.ai/catalog/standards/sist/e6e0cd59-2424-4d81-9e59-44f752894de2/sist-tp-cen-tr-16815-2016)

6 General architecture**6.1 General**

This application profile specification describes the virtual devices of municipal vehicle bodies (*CleANopen* units). Figure shows a simple example: The BC virtual device controls the overall system, however the other virtual devices communicate directly by means of PDOs. The virtual interfaces are implemented as CANopen interfaces or as CANopen device internal interfaces if the virtual devices reside in the same CANopen device. If the virtual interfaces between virtual devices are implemented as CANopen interfaces they use SDO or PDO services to read or write application objects.

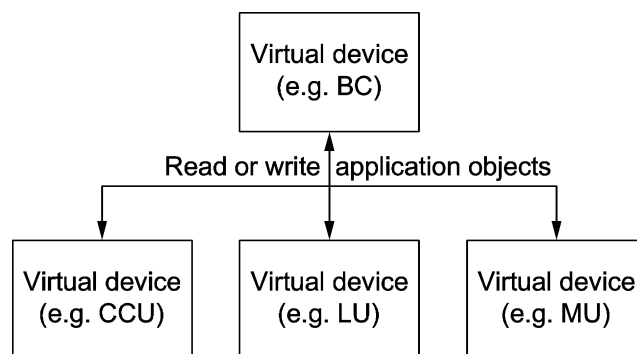

Figure 3 — Virtual devices interconnection (example)

Most of the application objects are mapped into pre-defined PDOs.

If an implemented application object is not mapped into one of the pre-defined PDOs, other CANopen devices can access them by means of SDO.

The CSDOs, which corresponds to the Default SSDO, shall be implemented always in the BC virtual device.

CANopen devices compliant to this application profile without BC functionality shall not implement any CSDO that relates to Default SSDO.

For systems not comprising a BC, additional SDO channels are needed.

This application profile pre-defines some SDO channels for dedicated functionality.

<https://standards.iteh.ai/catalog/standards/sist/e6e0cd59-2424-4d81-9e59->

For some virtual devices up to eight instances are specified. The instances with the very same number belong to one sub-system, e.g. LU 1, MU-A 1, and WU 1 belong to sub-system 1; LU 2, MU-B 2, and WU 2 belong to sub-system 2.

When the BC is implemented, it is connected to all sub-systems.

6.2 Communication to the in-vehicle networks

The communication to the truck's in-vehicle networks is possible by means of truck gateways provided by the truck manufacturer. There are different implementations on the market as shown in the examples given in Figure 4.

In the past, most truck manufacturers provided digital and analog inputs and outputs (a). In this implementation example, the TGU only transmits and receives those objects that are not used by the BC. It is also possible to implement the TGU in a generic I/O module compliant to [CiA 401 (b)]; it provides than TGU-compliant PDOs.

Nowadays, some truck manufacturers provide a [CiA 413] or [CiA 422] compliant truck gateway (c). In this implementation example, the truck gateway provides TPDOs and RPDOs that correspond to those provided by the TGU.

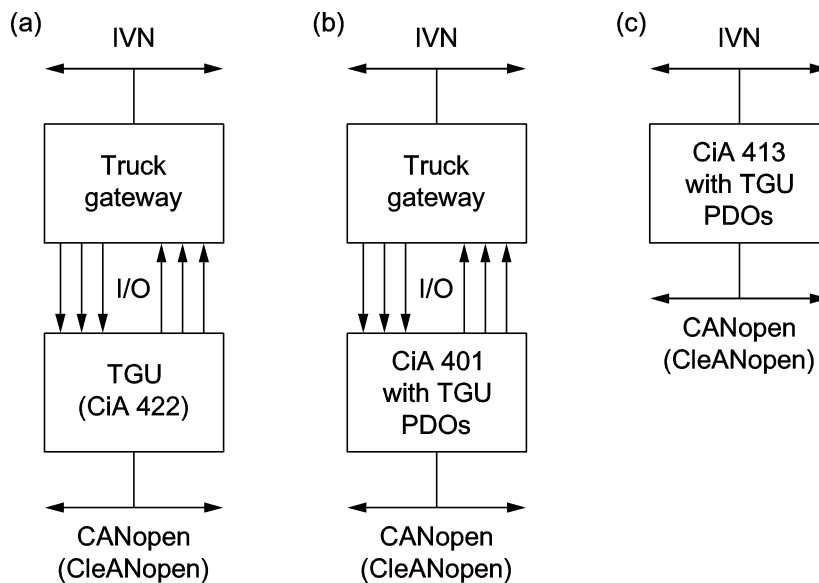

Figure 4 — Truck gateway implementation examples

If the TGU is implemented in the very same CANopen device as the BC, the communication can be done device-internally without transmitting COBs on the CAN network.

6.3 Numbering of the lifter units (LUs)

The LUs can be positioned on the vehicle in different ways. The numbering of the LUs as given in this clause shall be used for the vehicles implementing this specification. The lifter units shall be enumerated from left to right while standing in front of the lifter. One compartment consists of four LUs in maximum. The 1st compartment consists of LUs 1 to 4. If there is a second compartment on the truck (e.g. for organic waste) it consists of the LUs 5 to 8. For other configurations it is up to the system integrator to provide the LU numbering.

Figure 5 specifies the LU numbering for the single compartment front loader.

Figure 6 specifies the LU numbering for the single compartment rear loader.

Figure 7 specifies the LU numbering for the single compartment left side loader.

Figure 8 specifies the LU numbering for the single compartment right side loader.

Figure 9 specifies the LU numbering for the two-compartment rear loader.

Figure 10 specifies the LU numbering for the two-compartment combined rear and side loader.

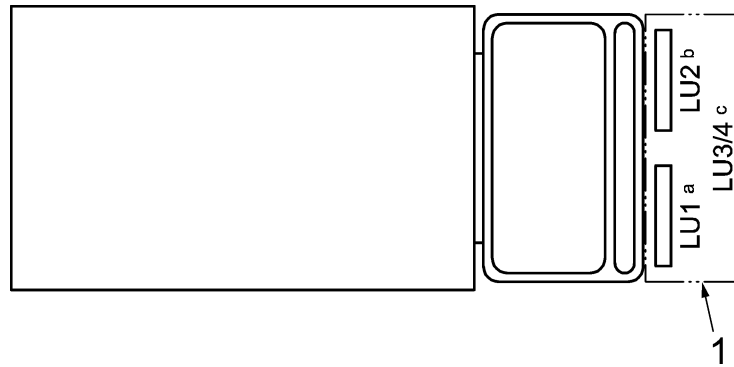

Figure 5 — LU numbering for the single compartment front loader



Figure 6 — LU numbering for the single compartment rear loader

<https://standards.iteh.ai/catalog/standards/sist/e6e0cd59-2424-4d81-9e59-44f752894de2/sist-tp-cen-tr-16815-2016>

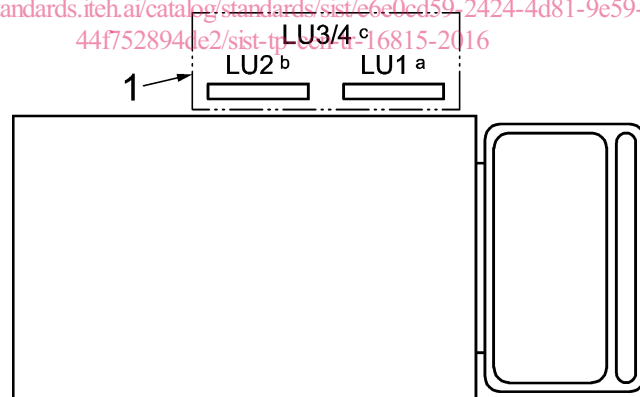

Figure 7 — LU numbering for the single compartment left side loader

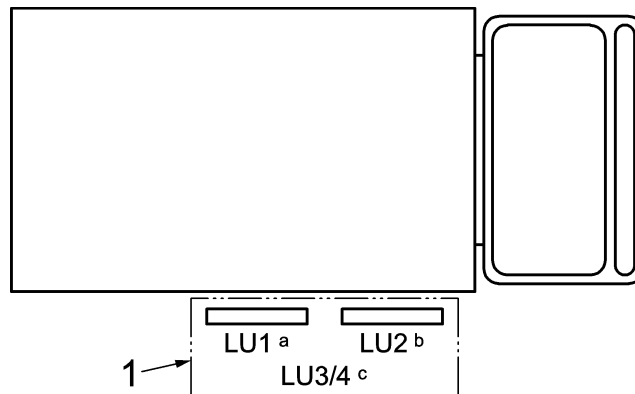

Figure 8 — LU numbering for the single compartment right side loader

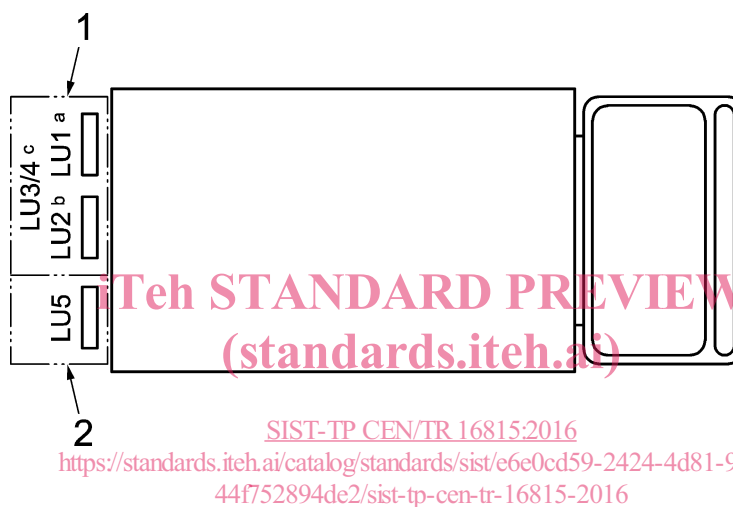

Figure 9 — LU numbering for the two compartment rear loader

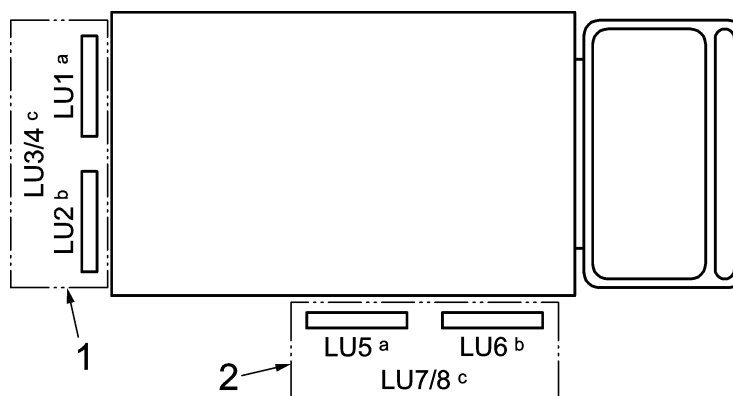

Figure 10 — LU numbering for the two compartment combined rear and side loader

6.4 Virtual device description

6.4.1 General

Every virtual device represents a specific functional unit. Some of them can be installed multiply in one application.

The following brief descriptions give an overview on the functionality of the different virtual devices.

The supported application objects are summarized in the clause on functionality of the virtual devices of this application profile.

The detailed PDO interfaces are specified in the appropriate clause on pre-defined Process Data Objects (PDO) of this application profile.

The detailed application objects are specified in the appropriate clause of this application profile.

6.4.2 Body controller (BC)

The BC is the interface to the hydraulic and the pneumatic power supply of the disposal vehicle. Related to its operating mode some other units request optionally the supply of pressure from the BC. Other units need optionally the BC status information (e.g. to estimate the intervals of maintenance) for their operations.

6.4.3 Bin classification unit (BCU)

The BCU classifies a waste bin attached to the lifter. Other units — virtual devices — use this classification for sequence control purposes:

- LU lifts and empties or does not lift and does not empty the bin.
- WU washes or does not wash the bin.

The BCU implements optionally the *measuring ident controller* (MIC) functional element. The MIC combines the results of identification (through the IDU) and a measuring (through the MU). The MIC coordinates the correct matching of measured values and the waste bin using information from IDU and LU. The MIC can detect (using the LU) the emptying of a waste bin with or without transponder.

There are up to eight BCU (1 to 8) instances possible in one logical *CleANopen* network.

6.4.4 Change container unit (CCU)

The CCU is used for changing the collecting reservoir (container) of a disposal vehicle. It is also used for providing information about the mounted container (fixed or changeable).

6.4.5 Compaction unit (CU)

The CU is used for compacting the waste and for providing information about the compaction process. It is used for synchronizing and for coordinating its activities with the LU. Other units use optionally the CU status information (e.g. to estimate the intervals of maintenance).

6.4.6 GPS unit (GPSU)

The GPSU is used for providing geographical positioning as well as date and time information, which is recorded by other units.

6.4.7 Identification unit (IDU)

The IDU is used for identifying waste bins by identifying a transponder attached to the waste bin. It can also write information to the transponder. The identification process is started by means of an explicit

CEN/TR 16815:2015 (E)

start command received from the MIC or automatically, when the IDU is supporting continuous identification.

6.4.8 Lifter unit (LU)

The LU is used for controlling the emptying procedure of a single waste bin. It is also used for informing additionally other units:

- about the state of a lifter,
- if a waste bin is attached or not,
- about the position of the lifter and whether the lifter is in the measuring window or not.

It is possible to configure the LU. For example, that the lifter adjust its speed in the emptying process. This is needed to consider the particular features of some other units (e.g. MU). The LU is used for communicating with the CU to inform it whether the CU is or not in operation. The LU is used for communicating with the BC to demand power supply (e.g. hydraulic).

There are up to eight LU (1 to 8) instances possible in one logical *CleANopen* network.

6.4.9 Measuring unit (MU)

The MU is used for issuing measurement results acquired while treating the bin or the container. The MU is used for abstracting particularly the functionality of scales or devices to measure the volume. As scale the MU is used for measuring the weight of waste in the waste bin. As volume measurement device the MU provides the volume of the disposed waste.

In some cases, it is necessary to measure up to two physical values on one lifter (e.g. weight and volume). For this case, the Measuring Unit A and Measuring Unit B are provided.

Especially for scales, modes for manual and automatic measuring are implemented. While automatic measurement the scale controls the entire weighing process. While manual measuring the user is responsible for control of the measuring process.

There are up to eight MU-A (1 to 8) and up to eight MU-B (1 to 8) instances possible in one logical *CleANopen* network.

6.4.10 Truck gateway unit (TGU)

The TGU is used for providing the access to the in-vehicle networks of the truck.

6.4.11 Washing unit (WU)

The WU is used for cleaning the waste bins. The LU provides the waste; it allows and starts the washing process. The WU informs about the state of the washing process and the washing equipment. While washing, no movement of the lifter is allowed.

There are up to eight WU (1 to 8) instances possible in one logical *CleANopen* network.

7 Physical layer specification

7.1 General

The CAN interface shall be compliant to the definitions and recommendations given in ISO 11898-2 and [CiA 301] and [CiA 303-1].

7.2 Bit rate

The physical CANopen device compliant to this application profile shall provide a default bit rate of 250 kbit/s and shall use the bit timing as specified in [CiA 301]. Other bit rates defined in [CiA 301] can be supported.

7.3 Bus topology

The bus topology shall be compliant to the definitions and recommendations given in ISO 11898-2, [CiA 301] and [CiA 303-1].

7.4 Bus cable

The bus cable used shall be compliant to the definitions and recommendations given in ISO 11898-2 and [CiA 303-1].

7.5 Bus connector

The bus connector used shall be compliant to the definitions and recommendations given in ISO 11898-2 and [CiA 303-1].

iTeh STANDARD PREVIEW
(standards.iteh.ai)

[SIST-TP CEN/TR 16815:2016](https://standards.iteh.ai/catalog/standards/sist/e6e0cd59-2424-4d81-9e59-44f752894de2/sist-tp-cen-tr-16815-2016)

<https://standards.iteh.ai/catalog/standards/sist/e6e0cd59-2424-4d81-9e59-44f752894de2/sist-tp-cen-tr-16815-2016>

7.6 Node-ID assignment

The assignment of a node-ID is required for every physical CANopen device. The assignment of node-IDs is manufacturer specific. For a better plug and play behaviour the assignment of the node-IDs is recommended as shown in Table 1.

Table 1 — Recommended node ID assignment

Device	Node-ID
Body controller (BC)	10
Compaction unit (CU)	11
Container change unit (CCU)	12
Lifter unit (LU) 1 to 8	20 to 27
Bin classification unit (BCU) 1 to 8	30 to 37
Identification unit (IDU) 1 to 8	50 to 57
Measuring unit A (MU-A) 1 to 8	60 to 67
Measuring unit B (MU-B) 1 to 8	70 to 77
Washing unit (WU) 1 to 8	80 to 87
Truck gateway unit (TGU)	89
GPS unit (GPSU)	90
Monitoring device 1 to 8	91 to 98