



**SLOVENSKI STANDARD**  
**SIST EN 71-1:2006+A9:2009**  
**01-november-2009**

**BUKca Yý U**  
**SIST EN 71-1:2006+A8:2009**

---

JUfbcgh][ fU '!%XY. AY Ubg\_Y]b`Zn] UbY`Ugfbcg[h]`fj \_`4 bc`n`Xcdc`b]ca `5-Ł

Safety of toys - Part 1: Mechanical and physical properties

Sicherheit von Spielzeug - Teil 1: Mechanische und physikalische Eigenschaften

**iTeh STANDARD PREVIEW**  
Sécurité des jouets - Partie 1: Propriétés mécaniques et physiques  
**(standards.iteh.ai)**

**Ta slovenski standard je istoveten z: EN 71-1:2005+A9:2009**

<https://standards.iteh.ai/catalog/standards/sist/4838749b-f0f0-4b00-81f9-9d8a42ed440e/sist-en-71-1-2006a9-2009>

---

**ICS:**

97.200.50      Q|æ^      Toys

**SIST EN 71-1:2006+A9:2009**      en,fr,de

**iTeh STANDARD PREVIEW**  
**(standards.iteh.ai)**

[SIST EN 71-1:2006+A9:2009](https://standards.iteh.ai/catalog/standards/sist/4838749b-f0f0-4b00-81f9-9d8a42cd440c/sist-en-71-1-2006a9-2009)

<https://standards.iteh.ai/catalog/standards/sist/4838749b-f0f0-4b00-81f9-9d8a42cd440c/sist-en-71-1-2006a9-2009>

EUROPEAN STANDARD  
NORME EUROPÉENNE  
EUROPÄISCHE NORM

**EN 71-1:2005+A9**

July 2009

ICS 97.200.50

Supersedes EN 71-1:2005+A8:2009

English Version

## Safety of toys - Part 1: Mechanical and physical properties

Sécurité des jouets - Partie 1: Propriétés mécaniques et physiques

Sicherheit von Spielzeug - Teil 1: Mechanische und physikalische Eigenschaften

This European Standard was approved by CEN on 19 September 2005 and includes Amendment 1, approved by CEN on 10 January 2007, Amendment 3 approved by CEN on 7 September 2006, Amendment 4 approved by CEN on 13 March 2007, Amendment 5 approved by CEN on 18 April 2008, Amendment 6 approved by CEN on 5 February 2008, Amendment 7 approved by CEN on 30 April 2009, Amendment 8 approved by CEN on 1 March 2009, Amendment 9 approved by CEN on 23 May 2009 and the Corrigendum issued in 2006.

CEN members are bound to comply with the CEN/CENELEC Internal Regulations which stipulate the conditions for giving this European Standard the status of a national standard without any alteration. Up-to-date lists and bibliographical references concerning such national standards may be obtained on application to the CEN Management Centre or to any CEN member.

This European Standard exists in three official versions (English, French, German). A version in any other language made by translation under the responsibility of a CEN member into its own language and notified to the CEN Management Centre has the same status as the official versions.

CEN members are the national standards bodies of Austria, Belgium, Bulgaria, Cyprus, Czech Republic, Denmark, Estonia, Finland, France, Germany, Greece, Hungary, Iceland, Ireland, Italy, Latvia, Lithuania, Luxembourg, Malta, Netherlands, Norway, Poland, Portugal, Romania, Slovakia, Slovenia, Spain, Sweden, Switzerland and United Kingdom.

<https://standards.iteh.ai/catalog/standards/sist/4838749b-f0f0-4b00-81f9-9d8a42cd440c/sist-en-71-1-2006a9-2009>



EUROPEAN COMMITTEE FOR STANDARDIZATION  
COMITÉ EUROPÉEN DE NORMALISATION  
EUROPÄISCHES KOMITEE FÜR NORMUNG

Management Centre: Avenue Marnix 17, B-1000 Brussels

## Contents

Page

Foreword.....	6
Introduction .....	8
1 Scope (see A.2) .....	9
2 Normative references .....	10
3 Terms and definitions .....	10
4 General requirements.....	15
4.1 Material (see A.3) .....	15
4.2 Assembly (see A.4).....	15
4.3 Flexible plastic sheeting (see A.5 and A.16) .....	16
4.4 Toy bags .....	16
4.5 Glass (see 5.7 and A.6).....	16
4.6 Expanding materials (see A.7).....	16
4.7 Edges (see A.8) .....	17
4.8 Points and $\text{A}_6$ metallic $\text{A}_6$ wires (see A.9).....	17
4.9 Protruding parts (see A.10).....	17
4.10 Parts moving against each other.....	18
4.10.1 Folding and sliding mechanisms (see A.11).....	18
4.10.2 Driving mechanisms (see A.12).....	20
4.10.3 Hinges (see A.13).....	20
4.10.4 Springs (see A.14).....	20
4.11 Mouth-actuated toys (see A.15).....	20
4.12 Balloons (see 4.3 and A.16).....	21
4.13 Cords of toy kites and other flying toys (see A.17).....	21
4.14 Enclosures.....	21
4.14.1 Toys which a child can enter (see A.18).....	21
4.14.2 Masks and helmets (see A.19).....	22
4.15 Toys intended to bear the mass of a child (see A.20).....	23
4.15.1 Toys propelled by a child or by other means .....	23
4.15.2 Free-wheeling toy bicycles (see A.20) .....	25
4.15.3 Rocking horses and similar toys (see A.21) .....	26
4.15.4 Toys not propelled by a child.....	27
4.15.5 Toy scooters (see A.49) .....	27
4.16 Heavy immobile toys .....	28
4.17 Projectiles (see A.22).....	28
4.17.1 General.....	28
4.17.2 Projectile toys without stored energy.....	29
4.17.3 Projectile toys with stored energy .....	29
4.17.4 Bows and arrows .....	29
4.18 Aquatic toys (see A.23) .....	30
4.19 $\text{A}_1$ Percussion caps specifically designed for use in toys and toys using percussion caps (see A.24) $\text{A}_1$ .....	30
4.20 Acoustics (see A.25).....	30
4.21 $\text{A}_6$ Toys containing a non-electrical heat source $\text{A}_6$ .....	31
4.22 Small balls (see 5.10 and A.48).....	31
4.23 Magnets (see A.51) .....	31
4.23.1 General.....	31
4.23.2 Toys other than magnetic/electrical experimental sets.....	32
4.23.3 Magnetic/electrical experimental sets .....	32
5 Toys intended for children under 36 months .....	32
5.1 General requirements (see A.26).....	32

5.2	Filling materials (see A.27) .....	33
5.3	Plastic sheeting (see A.28) .....	33
5.4	Cords on toys (see A.29) .....	33
5.5	Liquid-filled toys (see A.30).....	34
5.6	Speed limitation of electrically driven toys .....	34
5.7	Glass and porcelain (see 4.5 and A.6).....	35
5.8	Shape and size of certain toys (see A.31).....	35
5.9	Toys comprising monofilament fibres (see A.32) .....	35
5.10	Small balls (see also 4.22 and A.48) .....	35
5.11	Play figures .....	36
5.12	Hemispheric-shaped toys (see A.50).....	36
5.13	Suction cups .....	38
6	Packaging.....	39
7	Warnings and instructions for use (see A.33) .....	39
7.1	General .....	39
7.2	Toys not intended for children under 36 months (see A.34) .....	39
7.3	Latex balloons (see 4.12 and A.16).....	40
7.4	Aquatic toys (see 4.18 and A.23) .....	41
7.5	Functional toys (see A.35).....	41
7.6	Hazardous sharp functional edges and points (see 4.7 and 4.8) .....	41
7.7	Projectiles (see 4.17.3 c) and 4.17.4 c)).....	41
7.7.1	<b>A7</b> Toys with projectiles.....	41
7.7.2	Toys capable of discharging a projectile with a kinetic energy greater than 0,08 J .....	41
7.8	Imitation protective masks and helmets (see 4.14.2 and A.19) .....	41
7.9	Toy kites (see 4.13).....	42
7.10	Roller skates, inline skates and toy skateboards (see 4.15.1.2).....	42
7.11	Toys intended to be strung across a cradle, cot, or perambulator (see 5.4 e)).....	42
7.12	Liquid-filled teethingers (see 5.5).....	42
7.13	Percussion caps specifically designed for use in toys (see 4.19) .....	42
7.14	Acoustics (see 4.19 and 4.20 f)) <b>A4</b> EN 71-1:2006+A9:2009 .....	42
7.15	Toy bicycles (see 4.15.2.2) <b>A4</b> <a href="http://standards.sist.it/standards/sist/4838749b-f0fd-4b00-81f9-918279000000/EN_71-1:2006+A9:2009">http://standards.sist.it/standards/sist/4838749b-f0fd-4b00-81f9-918279000000/EN_71-1:2006+A9:2009</a> .....	42
7.16	<b>A4</b> Toys intended to bear the mass of a child (see 4.10.1, 4.15.1.2, 4.15.3 and 4.15.4) <b>A4</b> .....	43
7.17	Toys comprising monofilament fibres (see 5.9).....	43
7.18	Toy scooters (see 4.15.5.2).....	43
7.19	<b>A7</b> Rocking horses and similar toys (see 4.15.3 and A.21).....	43
7.20	<b>A8</b> Magnetic/electrical experimental sets (see 4.23 and A.51).....	44
8	Test methods .....	44
8.1	General requirements for testing.....	44
8.2	Small parts cylinder (see 4.6, 4.11, 4.18, 5.1, 5.2 and A.36).....	44
8.3	Torque test (see 4.6, 4.11, 4.14.2, 4.18, 4.22, 5.1, 5.10, 5.12 and 5.13).....	45
8.4	Tension test (see A.37) .....	45
8.4.1	Apparatus .....	45
8.4.2	Procedure .....	46
8.5	Drop test (see 4.6, 4.10.2, 4.14.2, 4.22, 5.1, 5.10, 5.12 and 5.13).....	46
8.6	Tip over test (see 4.10.2, 4.22, 5.1, 5.10 and 5.12) .....	47
8.7	Impact test (see 4.6, 4.10.2, 4.14.2, 4.22, 5.1, 5.10, 5.12, 5.13 and A.38).....	47
8.8	Compression test (see 4.6, 4.14.2, 4.22, 5.1, 5.10, 5.12, 5.13 and A.39) .....	47
8.9	Soaking test (see 4.11, 5.1, 5.10 and 5.12) .....	48
8.10	Accessibility of a part or component (see 4.5, 4.7, 4.8, 4.10.2, 4.10.4, 4.15.1.3, 4.21, 5.1 and 5.7).....	48
8.10.1	Principle.....	48
8.10.2	Apparatus .....	48
8.10.3	Procedure .....	48
8.11	Sharpness of edges (see 4.7, 4.9, 4.10.2, 4.14.2, 4.15.1.3 and 5.1) .....	50
8.11.1	Principle.....	50
8.11.2	Apparatus .....	50
8.11.3	Procedure .....	51
8.12	Sharpness of points (see 4.8, 4.10.2, 4.14.2, 4.15.1.3, 5.1 and A.40) .....	51
8.12.1	Principle.....	51

## EN 71-1:2005+A9:2009 (E)

8.12.2	Apparatus .....	51
8.12.3	Procedure .....	52
8.13	Flexibility of <b>A6</b> metallic <b>A6</b> wires (see 4.8 and A.41).....	53
8.13.1	<b>A6</b> General .....	53
8.13.2	Metallic wires and other metallic components intended to be bent.....	53
8.13.3	Metallic wires likely to be bent .....	53
8.14	Expanding materials (see 4.6) .....	53
8.15	Leakage of liquid-filled toys (see 5.5 and A.42).....	54
8.16	Geometric shape of certain toys (see 5.8, 5.11 and A.43) .....	54
8.17	<b>A4</b> Durability of mouth-actuated toys (see 4.11 and A.44) .....	55
8.17.1	Mouth-actuated projectile toys.....	55
8.17.2	Other mouth-actuated toys .....	55
8.18	Folding or sliding mechanisms (see 4.10.1 and A.45) .....	56
8.18.1	Loads .....	56
8.18.2	Toy pushchairs and perambulators .....	56
8.18.3	Other collapsible toys (see 4.10.1 c)).....	57
8.19	Electric resistivity of cords (see 4.13) .....	57
8.20	Cord thickness (see 5.4) .....	57
8.21	Static strength (see 4.15.1.3, 4.15.1.5, 4.15.3, 4.15.4 and A.46).....	57
8.22	Dynamic strength (see 4.15.1.3) .....	58
8.22.1	Principle .....	58
8.22.2	Loads .....	59
8.22.3	Procedure .....	59
8.23	Stability .....	61
8.23.1	Toys intended to bear the mass of a child (see 4.15.1.4, 4.15.3 and 4.15.4).....	61
8.23.2	Heavy immobile toys (see 4.16) .....	61
8.24	Determination of kinetic energy (see A.47) .....	61
8.24.1	Kinetic energy of projectiles (see 4.17.3) .....	61
8.24.2	Kinetic energy of bows and arrows (see 4.17.4).....	62
8.25	Plastic sheeting .....	62
8.25.1	Thickness (see 4.3, 5.3 and 6) .....	62
8.25.2	Adhesion (see 5.3) <a href="https://standards.iteh.ai/catalog/standards/sist/4838749b-f0fd-4b00-81f9-9d8a42cd440c/sist-en-71-1-2006a9-2009">https://standards.iteh.ai/catalog/standards/sist/4838749b-f0fd-4b00-81f9-9d8a42cd440c/sist-en-71-1-2006a9-2009</a> .....	62
8.26	Brake performance .....	62
8.26.1	Brake performance for toys other than toy bicycles (see 4.15.1.5).....	62
8.26.2	Brake performance for toy bicycles (see 4.15.2.4) .....	63
8.26.3	Brake performance for toy scooters (see 4.15.5.5) .....	63
8.27	Strength of toy scooter steering tubes (see 4.15.5.3) .....	64
8.27.1	Resistance to downward forces.....	64
8.27.2	Resistance to upward forces .....	65
8.28	Determination of emission sound pressure levels (see 4.20).....	65
8.28.1	Installation and mounting conditions.....	65
8.28.2	Measurement procedure .....	67
8.29	Determination of speed of electrically driven ride-on toys (see 5.6).....	71
8.30	Measurement of temperature rises (see 4.21) .....	71
8.31	Toy chest lids (see 4.14.1 c)) .....	71
8.31.1	Lid support .....	71
8.31.2	Durability test for vertically opening hinged lids .....	72
8.32	Small balls and suction cups test (see 4.22, 5.10 and 5.13).....	72
8.32.1	<b>A5</b> Small balls and suction cups <b>A5</b> .....	72
8.32.2	<b>A5</b> Small balls attached to a toy by a string.....	72
8.33	Test for play figures (see 5.11) .....	73
8.34	Tension test for magnets (see A.51) .....	73
8.34.1	General.....	73
8.34.2	Toys that contain more than one magnet or magnetic component .....	74
8.35	Magnetic flux index.....	74
8.35.1	General.....	74
8.35.2	Apparatus .....	74
8.35.3	Procedure .....	75
8.35.4	Calculation of magnetic flux index .....	75
Annex A	(informative) <b>A4</b> Background and rationale for this standard.....	76

A.1	General .....	76
A.2	Scope (see Clause 1).....	76
A.3	Material (see 4.1).....	77
A.4	Assembly (see 4.2) .....	77
A.5	Flexible plastic sheeting (see 4.3) .....	77
A.6	Glass (see 4.5 and 5.7) .....	77
A.7	Expanding materials (see 4.6).....	77
A.8	Edges (see 4.7) .....	77
A.9	Points and <b>A<sub>9</sub></b> metallic <b>A<sub>9</sub></b> wires (see 4.8) .....	78
A.10	Protruding parts (see 4.9).....	78
A.11	Folding and sliding mechanisms (see 4.10.1).....	79
A.12	Driving mechanisms (see 4.10.2).....	79
A.13	Hinges (see 4.10.3) .....	79
A.14	Springs (see 4.10.4).....	80
A.15	Mouth-actuated toys (see 4.11).....	80
A.16	Balloons (see 4.3, 4.12 and 7.3) .....	80
A.17	Cords of toy kites (see 4.13).....	80
A.18	Toys which a child can enter (see 4.14.1).....	80
A.19	Masks and helmets (see 4.14.2 and 7.8).....	81
A.20	Toys intended to bear the mass of a child (see 4.15) .....	81
A.21	Rocking horses and similar toys (see 4.15.3) .....	82
A.22	Projectiles (see 4.17).....	82
A.23	Aquatic toys (see 4.18 and 7.4).....	82
A.24	<b>A<sub>1</sub></b> Percussion caps specifically designed for use in toys and toys using percussion caps (see 4.19) <b>A<sub>1</sub></b> .....	83
A.25	Acoustics (see 4.20).....	83
A.26	General requirements for toys intended for children under 36 months (see 5.1) .....	83
A.27	Filling materials (see 5.2).....	84
A.28	Adhesion of plastic sheeting (see 5.3).....	84
A.29	Cords on toys (see 5.4).....	84
A.30	Liquid-filled toys (see 5.5 and <b>A.42</b> ).....	85
A.31	Shape and size of certain toys (see 5.8 and <b>A.43</b> ).....	85
A.32	Toys comprising monofilament fibres (see 5.9).....	85
A.33	Warnings and instructions for use (see 7.1).....	85
A.34	Warning for toys not intended for children under 36 months (see 7.2).....	85
A.35	Warnings in connection with functional toys (see 7.5) .....	86
A.36	Small parts cylinder (see 8.2).....	86
A.37	Tension test (see 8.4).....	86
A.38	Impact test (see 8.7) .....	86
A.39	Compression test (see 8.8).....	86
A.40	Sharpness of points (see 8.12) .....	86
A.41	Flexibility of <b>A<sub>9</sub></b> metallic <b>A<sub>9</sub></b> wires (see 8.13).....	86
A.42	Leakage of liquid-filled teething toys (see 8.15 and <b>A.30</b> ).....	87
A.43	Geometric shape of certain toys (see 8.16 and <b>A.31</b> ) .....	87
A.44	Durability of mouth-actuated toys (see 8.17).....	87
A.45	Folding or sliding mechanisms (see 8.18).....	87
A.46	Static strength (see 8.21).....	87
A.47	Kinetic energy of projectiles, bows and arrows (see 8.24) .....	87
A.48	Small balls (see 4.22 and 5.10) <del><b>A<sub>8</sub></b> deleted text <b>A<sub>8</sub></b></del> .....	87
A.49	Toy scooters (see 4.15.5).....	89
A.50	Hemispheric-shaped toys (see 5.12) .....	89
A.51	Magnets (see 4.23).....	89
Annex ZA (informative) Clauses of this European Standard addressing essential requirements or other provisions of EU Directives.....		92
Bibliography.....		94



## EN 71-1:2005+A9:2009 (E)

## Foreword

This document (EN 71-1:2005+A9:2009) has been prepared by Technical Committee CEN/TC 52 "Safety of toys", the secretariat of which is held by DS.

This European Standard shall be given the status of a national standard, either by publication of an identical text or by endorsement, at the latest by January 2010, and conflicting national standards shall be withdrawn at the latest by January 2010.

This document includes Amendment 1, approved by CEN on 2007-01-10, Amendment 3 approved by CEN on 2006-09-07, Amendment 4 approved by CEN on 2007-03-13, Amendment 5 approved by CEN on 2008-04-18, Amendment 6 approved by CEN on 2008-02-05, Amendment 7 approved by CEN on 2009-04-30, Amendment 8 approved by CEN on 2009-03-01, Amendment 9 approved by CEN on 2009-05-23 and the Corrigendum issued on 2006-02-01.

This document supersedes A9 EN 71-1:2005+A8:2009 A9.

The start and finish of text introduced or altered by amendment is indicated in the text by tags A1 A1, A3 A3, A4 A4, A5 A5, A6 A6, A7 A7, A8 A8 and A9 A9.

The modifications of the related CEN Corrigendum have been implemented at the appropriate places in the text and are indicated by the tags AC AC.

A4 *deleted text* A4

**iTeh STANDARD PREVIEW**  
(standards.iteh.ai)

This European Standard has been prepared under a mandate given to CEN by the European Commission and the European Free Trade Association, and supports essential requirements of EU Directive(s).

For relationship with EU Directive(s), see informative Annex ZA, which is an integral part of this European Standard.

This European Standard constitutes the first part of the European Standard on safety of toys.

This European Standard for safety of toys consists of the following parts:

- Part 1: *Mechanical and physical properties*
- Part 2: *Flammability*
- Part 3: *Migration of certain elements*
- Part 4: *Experimental sets for chemistry and related activities*
- Part 5: *Chemical toys (sets) other than experimental sets*
- Part 7: *Finger paints – Requirements and test methods*
- Part 8: *Swings, slides and similar activity toys for indoor and outdoor family domestic use*
- Part 9: *Organic chemical compounds – Requirements*
- Part 10: *Organic chemical compounds – Sample preparation and extraction*
- Part 11: *Organic chemical compounds – Methods of analysis*

NOTE 1 In addition to the above parts of EN 71, the following guidance documents have been published: CEN Report, CR 14379:2002, *Classification of toys - Guidelines*, CEN Technical Report CEN/TR 15071:2005, *Safety of toys - National translations of warnings and instructions for use in EN 71* and CEN Technical Report CEN/TR 15371:2009, *Safety of toys – Replies to requests for interpretation of EN 71-1, EN 71-2, and EN 71-8* A4.

NOTE 2 Different legal requirements may exist in non-EU countries.

According to the CEN/CENELEC Internal Regulations, the national standards organizations of the following countries are bound to implement this European Standard: Austria, Belgium, Bulgaria, Cyprus, Czech Republic, Denmark, Estonia, Finland, France, Germany, Greece, Hungary, Iceland, Ireland, Italy, Latvia,



Lithuania, Luxembourg, Malta, Netherlands, Norway, Poland, Portugal, Romania, Slovakia, Slovenia, Spain, Sweden, Switzerland and United Kingdom.

**iTeh STANDARD PREVIEW**  
**(standards.iteh.ai)**

SIST EN 71-1:2006+A9:2009  
<https://standards.iteh.ai/catalog/standards/sist/4838749b-f0f0-4b00-81f9-9d8a42cd440c/sist-en-71-1-2006a9-2009>

**EN 71-1:2005+A9:2009 (E)****Introduction**

The European Standards aim at reducing as far as possible those risks which are not evident to users; they do not cover inherent dangers (e.g. instability of scooters, sharp needles in a sewing kit etc.) that are obvious to children or the persons in charge of them. Assuming that the toys are used in the manner for which they are intended, they should not present any further risk to children for whom they are intended. Allowance should also be made for normal or foreseeable use, bearing in mind the normal behaviour of children who do not generally share the same degree of care as the average adult user.

As a general rule, toys are designed and manufactured for particular ages of children. Their characteristics are related to the age and stage of development of the children, and their use presupposes certain aptitudes.

Accidents are frequently due to a toy either being given to a child for whom it is not intended, or being used for a purpose other than that for which it was designed. Great care should therefore be taken when choosing a toy or game; account should be taken of the mental and physical development of the child who will be using it.

The requirements of this European Standard do not release parents or carers from their responsibility of watching over the child while he or she is playing.

## **iTeh STANDARD PREVIEW (standards.iteh.ai)**

[SIST EN 71-1:2006+A9:2009](https://standards.iteh.ai/catalog/standards/sist/4838749b-f0f0-4b00-81f9-9d8a42cd440c/sist-en-71-1-2006a9-2009)

<https://standards.iteh.ai/catalog/standards/sist/4838749b-f0f0-4b00-81f9-9d8a42cd440c/sist-en-71-1-2006a9-2009>

## 1 Scope (see A.2)



This European Standard specifies requirements and methods of tests for mechanical and physical properties of toys.

This European Standard applies to toys for children, toys being any product or material designed or clearly intended for use in play by children of less than 14 years. It refers to new toys taking into account the period of foreseeable and normal use, and that the toys are used as intended or in a foreseeable way, bearing in mind the normal behaviour of children.

It includes specific requirements for toys intended for children under 36 months and for children who are too young to sit up unaided. For the purpose of this European Standard, *soft-filled* toys with simple features intended for holding and cuddling are considered as toys intended for children under 36 months.

This European Standard also specifies requirements for *packaging*, marking and labelling.

This European Standard does not cover musical instruments, sports equipment or similar items but does include their toy counterparts.

This European Standard does not cover electrical safety aspects of toys. These are covered by  EN 62115, Electric toys - Safety .

Furthermore, it does not cover the following items which, for the purpose of this European Standard, are not considered as toys:

- STANDARD PREVIEW**  
(standards.iteh.ai)
- Christmas decorations (see A.2);
  - detailed scale models for adult collectors (see A.2);
  - equipment intended to be used collectively in playgrounds;
  - sports equipment;
  - aquatic equipment intended to be used in deep water;
  - folk dolls and decorative dolls and other similar articles for adult collectors;
  - "professional" toys installed in public places (shopping centres, stations etc.) (see A.2);
  - puzzles with more than 500 pieces or without picture, intended for specialists;
  - air guns and air pistols (see A.2);
  - fireworks, including percussion caps except percussion caps specifically designed for toys;
  - slings and catapults (see A.2);
  - sets of darts with metallic points;
  - electric ovens, irons or other functional products operated at a nominal voltage exceeding 24 V;
  - products containing heating elements intended for use under the supervision of an adult in a teaching context;
  - vehicles with combustion engines (see A.2);
  - toy steam engines;
  - bicycles designed for sport or for travel on the public highway;
  - video toys that can be connected to a video screen, operated at a nominal voltage exceeding 24V;
  - babies' dummies (soothers);
  - faithful reproductions of real fire arms;
  - fashion jewellery for children (see A.2).

Also, for the purpose of this European Standard, the following items are not considered as toys:

- flotation aids such as arm bands and swim seats (see A.23);
- swimming goggles, sunglasses and other eye protectors as well as bicycle and skateboard helmets (see A.19);
- items that are propelled into free flight by a child releasing an elastic band (e.g. aeroplanes and rockets). These are considered as catapults (see 11th indent above);
- bows for archery with an overall relaxed length exceeding 120 cm.

**EN 71-1:2005+A9:2009 (E)****2 Normative references**

The following referenced documents are indispensable for the application of this European Standard. For dated references, only the edition cited applies. For undated references, the latest edition of the referenced document (including any amendments) applies.

 deleted text 



EN 71-8, *Safety of toys — Part 8: Swings, slides and similar activity toys for indoor and outdoor family domestic use*

EN 60318-1, *Electroacoustics — Simulators of human head and ear — Part 1: Ear simulator for the calibration of supra-aural earphones (IEC 60318-1:1998)*

EN ISO 868, *Plastics and ebonite — Determination of indentation hardness by means of a durometer (Shore hardness) (ISO 868:2003)*

EN ISO 3746:1995, *Acoustics — Determination of sound power levels of noise sources using sound pressure - Survey method using an enveloping measurement surface over a reflecting plane (ISO 3746:1995)*

EN ISO 4287, *Geometrical product specifications (GPS) - Surface texture: Profile method - Terms, definitions and surface texture parameters (ISO 4287:1997)*

EN ISO 6508-1, *Metallic materials — Rockwell hardness test — Part 1: Test method (scales A, B, C, D, E, F, G, H, K, N, T)  (ISO 6508-1:2005) *



EN ISO 11201, *Acoustics — Noise emitted by machinery and equipment — Measurement of emission sound pressure levels at a work station and at other specified positions — Engineering method in an essentially free field over a reflecting plane (ISO 11201:1995)*

EN ISO 11202, *Acoustics — Noise emitted by machinery and equipment — Measurement of emission sound pressure levels at a work station and at other specified positions — Survey method in situ (ISO 11202:1995)*

EN ISO 11204, *Acoustics — Noise emitted by machinery and equipment — Measurement of emission sound pressure levels at a work station and at other specified positions — Method requiring environmental corrections (ISO 11204:1995)*

ISO 4593, *Plastics — Film and sheeting — Determination of thickness by mechanical scanning*

ISO 7619-2, *Rubber, vulcanized or thermoplastic — Determination of indentation hardness — Part 2: IRHD pocket meter method*

 IEC 60318-5, *Electroacoustics – Simulators of human head and ear – Part 5: 2 cm<sup>3</sup> coupler for the measurement of hearing aids and earphones coupled to the ear by means of ear inserts *

**3 Terms and definitions**

For the purpose of this European Standard, the following terms and definitions apply.

**3.1****accessible**

contactable under the test conditions of 8.10 (accessibility of a part or component)

**3.2****aquatic toy**

article, whether inflatable or not, intended to bear the mass of a child and used as an instrument of play in shallow water

**3.3****backing**

material adhering to flexible *plastic sheeting*

**3.4****ball**

<sup>A5</sup> spherical, ovoid, or ellipsoidal object, usually but not always, designed or intended to be thrown, hit, kicked, rolled, dropped or bounced

The term *ball* also includes any multisided object formed by at least 48 connecting planes into a generally spherical, ovoid or ellipsoidal shape <sup>A5</sup>

<sup>A6</sup> *deleted text* <sup>A6</sup>

**3.5****burr**

roughness, caused by not cleanly severing or finishing the material

**3.6****close-to-the-ear toy**

toy that is clearly designed to emit sound, intended to be used close to the ear, i.e. a hypothetical position, normally 2,5 cm from the nearest sound emitting part of the toy that can be put against the ear of a child (e.g. telephones that ring or beep in the ear piece and toys with earphones)

**3.7****collapse**

sudden or unexpected folding of a structure

**3.8****cord**

piece of slender, flexible material including monofilaments, woven and twisted cord, rope, plastic textile tapes, ribbon and those fibrous materials commonly called string

NOTE Monofilament doll hair is not considered as a cord.

**3.9****crack**

fracture of a material to the full thickness of the material

**3.10****crushing**

injury to part of the body resulting from compression between two surfaces

**3.11****driving mechanism**

assembly of linked parts of a toy, at least one of which moves and is driven either electrically, by clockwork or by other mechanical means and including gears, belts and winding mechanisms

**3.12****edge**

line formed at the junction of two surfaces, the length of which exceeds 2,0 mm



**3.13****expanding material**

material, the volume of which expands when the material is exposed to water

**3.14****fastening**

mechanical device which attaches two or more components of a toy together (e.g. a screw)

**EN 71-1:2005+A9:2009 (E)****3.15  
filling**

material intended to be wholly contained within a *soft-filled* toy  or within *soft-filled* parts of a toy 

**3.16  
free-wheeling toy bicycle**

two-wheeled vehicle, with or without stabilisers, with a *maximum saddle height* of 435 mm or less and which is propelled solely by the muscular energy of the person on that vehicle, in particular by means of pedals, and which does not have a fixed transmitted drive

**3.17  
functional edge or point**

*edge* or *point* which is essential for the functioning of a toy (e.g. microscope slides, electrical conductors, needles)

**3.18  
functional toy**

toy which performs and is used in the same way as an appliance or an installation intended for adults and is often a scale model of a certain product (e.g. a stove with heating properties)

**3.19  
fuzz**

bits of fibrous type material that can be readily removed from toys with a pile surface

**3.20  
hand-held toy**

toy that is clearly designed to emit sound, intended to be held in the hand (e.g. clicking toys, toy *tools*, musical toys and cap-firing toys) but excluding *close-to-the-ear* toys and child-actuated toys as well as mouth-actuated toys

**3.21  
hinge line**

line along or parallel to the line projected through the axis of rotation as shown in Figure 1

iTeh STANDARD PREVIEW  
(standards.iteh.ai)

SIST EN 71-1:2006+A9:2009  
<https://standards.iteh.ai/catalog/standards/sist/4838749b-f0f0-4b00-81f9-9d8a42ed440c/sist-en-71-1-2006a9-2009>

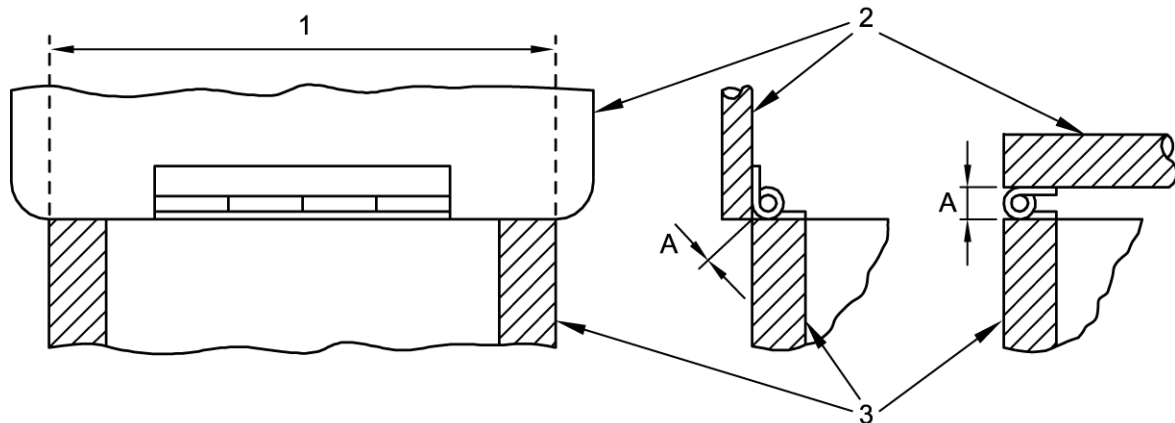
**Key**

- 1 Hinge line
- 2 Lid
- 3 Box
- A Hinge-line clearance between assembled edges

**Figure 1 – Definition of hinge line****3.22****large and bulky toy**

toy that has a projected base area of more than 0,26 m<sup>2</sup> or a volume of more than 0,08 m<sup>3</sup> calculated without regard to minor appendages, or a mass of 4,5 kg or more

NOTE The base area of a toy having permanently attached legs, is the area enclosed by straight lines connecting the outermost edge of each leg of the perimeter.

**3.23****maximum saddle height**

vertical distance from the ground to the top of the seat surface, measured with the seat in a horizontal position and with the seat pillar set to the minimum insertion mark

**3.24****overlap joint**

joint in which an edge overlaps a parallel surface but is not necessarily mechanically attached to it at all points along the length

**3.25****packaging**

material accompanying the toy when purchased but having no intended play function

**3.26****paper**

material, marketed as either paper or paperboard, with a mass per unit area of 400 g/m<sup>2</sup> or less

**3.27****particle**

object with a discrete three-dimensional form (e.g. expanded polystyrene), but excluding fibrous material

**3.28****plastic sheeting**

thin section plastic sheeting which is used as part of the toy or as part of the packaging

**3.29****projectile**

object intended to be launched into free flight or a trajectory in the air