



Designation: F 2291 – 04

## Standard Practice for Design of Amusement Rides and Devices<sup>1</sup>

This standard is issued under the fixed designation F 2291; the number immediately following the designation indicates the year of original adoption or, in the case of revision, the year of last revision. A number in parentheses indicates the year of last approval. A superscript epsilon ( $\epsilon$ ) indicates an editorial change since the last revision or reapproval.

### 1. Scope

1.1 This practice establishes criteria for the design of amusement rides, devices and major modifications to amusement rides and devices manufactured after the effective date of publication except as noted in 1.2.

1.2 This practice shall not apply to:

1.2.1 Patron directed amusement rides or devices (for example, go karts, bumper cars, bumper boats),

1.2.2 Artificial climbing walls,

1.2.3 Air-supported structures,

1.2.4 dry slides,

1.2.5 coin operated rides,

1.2.6 Amusement rides or devices that involve the purposeful immersion of the patron's body partially or totally in the water and involves more than incidental patron water contact (for example, pools, water slides, lazy rivers, interactive aquatic play devices),

1.2.7 Amusement rides and devices whose design criteria are specifically addressed in another ASTM standard,

1.2.8 Portions of an amusement ride or device unaffected by a major modification,

1.2.9 Upgrades to electrical wiring, electrical motors and electrical components of amusement rides and devices provided the original design and safety criteria are maintained or enhanced, and

1.2.10 Pre-existing designs manufactured after the effective date of publication of this practice if the design is service proven or previously compliant and the manufacturer provides:

1.2.10.1 A historical summary of the amusement ride, device or major modification, and

1.2.10.2 A statement that the design is service proven or previously compliant as specified by Section 3.

1.2.11 Amusement rides and devices, and major modifications to amusement rides and devices may qualify as "previously compliant" for five years following the date of publication of this practice. Thereafter, amusement rides and devices,

and major modifications to amusement rides and devices must qualify as "service proven" or meet the requirements of this practice.

1.3 This practice includes an annex (mandatory), which provides additional information (for example, rationale, background, interpretations, drawings, commentary, and so forth) to improve the user's understanding and application of the criteria presented in this practice. The annex information shall be interpreted as mandatory design criteria.

1.4 This practice includes an appendix (non-mandatory), which provides additional information (for example, rationale, background, interpretations, drawings, commentary, and so forth.) to improve the user's understanding and application of the criteria presented in this practice. The appendix information shall not be interpreted as mandatory design criteria.

1.5 *This standard does not purport to address all of the safety concerns, if any, associated with its use. It is the responsibility of the user of this standard to establish appropriate safety and health practices and determine the applicability of regulatory limitations prior to use.*

### 2. Referenced Documents

#### 2.1 ASTM Standards:<sup>2</sup>

F 698 Specification for Physical Information to be Provided for Amusement Rides and Devices

F 747 Terminology Relating to Amusement Rides and Devices

F 770 Practice for Operation Procedures for Amusement Rides and Devices

F 846 Guide for Testing Performance of Amusement Rides and Devices

F 853 Practice for Maintenance Procedures for Amusement Rides and Devices

F 893 Guide for Inspection of Amusement Rides and Devices

F 1159 Practice for Design and Manufacture of Patron Directed, Artificial Climbing Walls, Dry Slide, Coin Operated and Purposeful Water Immersion Amusement Rides

<sup>1</sup> This practice is under the jurisdiction of ASTM Committee F24 on Amusement Rides and Devices and is the direct responsibility of Subcommittee F24.24 on Design and Manufacture.

Current edition approved April 1, 2004. Published April 2004. Originally approved in 2003. Last previous edition approved in 2003 as F 2291 – 03a.

<sup>2</sup> For referenced ASTM standards, visit the ASTM website, www.astm.org, or contact ASTM Customer Service at service@astm.org. For *Annual Book of ASTM Standards* volume information, refer to the standard's Document Summary page on the ASTM website.

- and Devices and Air-Supported Structures  
 F 2137 Practice for Measuring the Dynamic Characteristics of Amusement Rides and Devices
- 2.2 *ASTM Technical Publications*:<sup>3</sup>  
 MIL 17 The Composite Materials Handbook  
 MIL 882C System Safety Program Requirements  
 STP-1330 Composite Materials: Fatigue and Fracture, 7th Volume
- 2.3 *ACI (American Concrete Institute)*:  
 ACI-301 Specifications for Structural Concrete  
 ACI-318 Building Code Requirements for Structural Concrete (ACI-318) and Commentary (318R)
- 2.4 *AFPA (American Forest & Paper Association), American Wood Council Publications*:<sup>4</sup>  
 NDS (National Design Standard) for ASD Design
- 2.5 *AISC (American Institute of Steel Construction)*:<sup>5</sup>  
 AISC 316 Manual on Steel Construction, Allowable Stress Design (ASD)  
 AISC M015 Manual on Steel Construction, Load & Resistance Factor Design (LRFD)
- 2.6 *ANSI (American National Standards Institute)*:<sup>6</sup>  
 ANSI B93.114M Pneumatic Fluid Power—Systems Standard for Industrial Machinery  
 ANSI B11.TR3 Risk Assessment and Risk Reduction—A Guide to Estimate, Evaluate, and Reduce Risks Associated with Machine Tools  
 ANSI B77.1 Passenger Ropeways—Aerial Tramways, Aerial Lifts, Surface Lifts, Tows and Conveyors—Safety Requirements
- 2.7 *ASCE (American Society of Civil Engineers)*:<sup>7</sup>  
 ASCE 7 Minimum Design Loads for Buildings and Other Structures  
 ASCE 16 Standard for Load and Resistance Factor Design (LRFD) for Engineered Wood Construction
- 2.8 *ASMI (American Society of Metals International)*:<sup>8</sup>  
 ASM Atlas of Fatigue Curves  
 ASM Handbook Volume 19: Fatigue and Fracture
- 2.9 *ASME (American Society of Mechanical Engineers)*:<sup>8</sup>  
 ASME B15.1 Safety Standards for Mechanical Power Transmission Apparatus  
 ASME A17.1 Safety Code for Elevators and Escalators
- 2.10 *AWS (American Welding Society)*:<sup>9</sup>  
 ANSI/AWS D1.1/D1.1M Structural Welding Code—Steel  
 ANSI/AWS D14.4 Specification for Welded Joints in Machinery and Equipment
- 2.11 *British Standards Institute*:<sup>10</sup>  
 BS 5400-10 Steel, Concrete and Composite Bridges—Code of Practice for Fatigue  
 BS 7608 Code of Practice for Fatigue Design and Assessment of Steel Structures
- 2.12 *CDC (Center for Disease Control) Growth Charts*:<sup>11</sup>  
 CDC Basic Body Measurements
- 2.13 *CISC (Canadian Institute of Steel Construction)*:  
 Hollow Structural Section Connection and Trusses—A Design Guide, J.A. Parker and J.E. Henderson
- 2.14 *DIN (German Institute For Standardization)*:<sup>12</sup>  
 DIN 15018-1, Cranes; Steel Structures; Verification and Analyses Data
- 2.15 *EN (European Committee for Standardization)*:  
 EN 280 Mobile Elevating Work Platforms—Design Calculations, Stability Criteria, Construction, Safety, Examinations, and Tests  
 EN 954-1 Safety of Machinery—Safety Related Parts of Control Systems—General Principles for Design  
 EN 1050 Safety of Machinery—Principles for Risk Assessment  
 EN 1993-1-9, Eurocode 3 Design of Steel Structures. Part 1.9. Fatigue Strength of Steel Structures  
 EN 1993-1-9, Eurocode 3 Design of Steel Structures. Part 6.9. Crane Supporting Structures—Fatigue Strength  
 EN 60947-1 Low-Voltage Switchgear and Controlgear
- 2.16 *IEC (Cable Assemblies Interface Equipment)*:  
 IEC-60204-1 Safety of Machinery—Electrical Equipment of Machines—Part 1: General Requirements  
 IEC-61496-1 Safety of Machinery—Electrosensitive Protective Equipment—General Requirements and Tests  
 IEC-61508-1 Functional Safety of Electrical/Electronic/Programmable Electronic Safety-Related Systems—General Requirements  
 IEC-61511 Functional Safety: Safety Instrumented Systems for the Process Industry Sector  
 IEC-62061 Safety of Machinery-Functional Safety-Electrical, Electronic, and Programmable Electronic Control Systems
- 2.17 *Federal Documents*:  
 USDA-72 (U.S. Dept. of Agriculture) The Wood Handbook—Wood As An Engineering Material, Forest Service, Forest Products Laboratory
- 2.18 *ISO (International Standards Organization)*:<sup>13</sup>  
 ISO 4414 Pneumatic Fluid Power General Rules Relating to Systems
- 2.19 *NEMA (National Electrical Manufacturers Association)*:<sup>14</sup>  
 NEMA 250 Enclosures for Electrical Equipment

<sup>3</sup> Available from ASTM International Headquarters, 100 Barr Harbor Drive, PO Box C700, West Conshohocken, PA 19428-2959.

<sup>4</sup> Available from American Forest and Paper Association (AF&PA), 1111 19th St., NW, Suite 800, Washington, DC 20036.

<sup>5</sup> Available from American Institute of Steel Construction (AISC), One E. Wacker Dr., Suite 3100, Chicago, IL 60601-2001.

<sup>6</sup> Available from American National Standards Institute (ANSI), 25 W. 43rd St., 4th Floor, New York, NY 10036.

<sup>7</sup> Available from The American Society of Civil Engineers (ASCE), 1801 Alexander Bell Dr., Reston, VA 20191.

<sup>8</sup> Available from American Society of Mechanical Engineers (ASME), ASME International Headquarters, Three Park Ave., New York, NY 10016-5990.

<sup>9</sup> Available from The American Welding Society (AWS), 550 NW LeJeune Rd., Miami, FL 33126.

<sup>10</sup> Available from British Standards Institute (BSI), 389 Chiswick High Rd., London W4 4AL, U.K.

<sup>11</sup> Available from Centers for Disease Control & Prevention (CDC), 1600 Clifton Rd., Atlanta, GA 30333, website: <http://www.cdc.gov/> [Search: anthropometrics].

<sup>12</sup> Available from Beuth Verlag GmbH (DIN-- DIN Deutsches Institut für Normung e.V.), Burggrafenstrasse 6, 10787, Berlin, Germany.

<sup>13</sup> Available from International Organization for Standardization (ISO), 1 rue de Varembeé, Case postale 56, CH-1211, Geneva 20, Switzerland.

<sup>14</sup> Available from National Electrical Manufacturers Association (NEMA), 1300 N. 17th St., Suite 1847, Rosslyn, VA 22209.

2.20 NFPA (National Fire Protection Agency):<sup>15</sup>

NFPA-79 Electrical Standard for Industrial Machinery

NFPA-70 National Electric Code (NEC)

NFPA-101 Life Safety Code

2.21 National Fluid Power Association, Inc.<sup>16</sup>

NFPA/JIC T2.25.1M Pneumatic Fluid Power—Systems Standard for Industrial Machinery

2.22 OIPEEC (International Organization for the Study of Endurance of Wire Rope)<sup>17</sup>

2.23 SAE (Society of Automotive Engineers):<sup>18</sup>

SAE J-211 Instrumentation for Impact Test—Electronic Instrumentation

SAE J-833 Human Physical Dimensions

SAE HS 4000 Fastener Standards

2.24 UL (Underwriter's Laboratory):<sup>19</sup>

UL 508 Industrial Control Equipment

UL 508A Industrial Control Panels

### 3. Terminology

3.1 *Definitions of Terms Specific to This Standard:*

3.1.1 *acceleration, impact*—those accelerations with duration of less than 200 ms.

3.1.2 *acceleration, sustained*—those accelerations with duration greater than or equal to 200 ms.

3.1.3 *automatic mode*—the ability, after initialization, of the amusement ride or device to start, operate, move, etc. with limited or no operator intervention.

3.1.4 *closed*—when pertaining to restraint devices, the position in which the restraint is intended to remain during the operation of the ride or device in order to restrain the patron(s).

3.1.5 *designer/engineer*—the party(s) that establishes and describes the configuration of the amusement ride or device, establishes strength and fatigue life, designs and develops electrical/electronic control systems, and defines inspection criteria.

3.1.6 *electrical (E)/electronic (E)/programmable electronic systems (PES) (E/E/PES)*—when used in this context, electrical refers to logic functions performed by electromechanical techniques, (for example, electromechanical relay, motor driven timers, etc.), Electronic refers to logic functions performed by electronic techniques, (for example, solid state logic, solid state relay, etc.), and Programmable Electronic System refers to logic performed by programmable or configurable devices (for example, Programmable Logic Controller (PLC)). Field devices are not included in E/E/PES.

3.1.7 *electro-sensitive protective equipment (ESPE)*—an assembly of devices or components, or both, working together for protective tripping or presence-sensing purposes.

3.1.8 *emergency stop (E-Stop)*—a shut down sequence(s), other than a normal stop, that brings the amusement ride or device to a stop. An E-Stop may be more dynamic than a normal stop.

3.1.9 *fail-safe*—a characteristic of an amusement ride or device, or component thereof, that is designed such that the normal and expected failure mode results in a safe condition.

3.1.10 *fence*—a type of barrier consisting of, but not limited to, posts, boards, wire, stakes, or rails that is used to inhibit patrons from coming into undesirable contact with the moving portion or restricted portion of an amusement ride or device.

3.1.11 *filter corner frequency (Fc)*—with reference to a low-pass filter, Fc is the frequency (specified in Hz) where the frequency response curve of the filter has magnitude of –3 dB.

3.1.12 *force limiting*—when pertaining to restraint devices, a characteristic that, regardless of the amount of force available from the system actuators, limits the amount of force applied to the patron(s).

3.1.13 *gates*—a section of fencing that may be opened.

3.1.14 *guardrail*—system of building components located near the open sides of elevated walking surfaces for the purpose of minimizing the possibility of an accidental fall from the walking surface to the lower level.

3.1.15 *hand mode*—the ability of the amusement ride or device to start, operate, move, etc. only with operator intervention.

3.1.16 *handrail*—railing provided for grasping with the hand for support.

3.1.17 *latching*—when pertaining to restraint devices, held secure against opening except by intentional action of the patron, operator, or other means. This can include restraints (for example, drop bars) held in place by gravity, detents or other means.

3.1.18 *locking*—when pertaining to restraint devices, held securely against opening except by intentional action of the operator or other means not accessible by the patron.

3.1.19 *manual release*—when pertaining to restraint devices, a hand or foot operated mechanism that allows for opening the patron restraint.

3.1.20 *manufacturer*—the party producing the amusement ride or device, performing major modifications and can include the designer/engineer.

3.1.21 *patron containment*—the features in an amusement ride or device that accommodate the patron for the purpose of riding the ride or device. This may include but is not limited to the seats, side walls, walls, or bulkheads ahead of the patron(s), floors, objects within the vicinity of the patron(s), restraint systems, and cages.

3.1.22 *previously compliant*—an amusement ride or device, or major modification to an amusement ride or device, of which the design meets the ASTM Standard in place at the time of its design.

3.1.23 *primary circulation area*—areas leading directly to the entrance and exit of a ride that are normally traveled by patrons. These areas would not include emergency exit routes, maintenance areas, or other areas not normally on the route of the patron.

<sup>15</sup> Available from National Fire Protection Association (NFPA), 1 Batterymarch Park, Quincy, MA 02269-9101.

<sup>16</sup> Available from National Fluid Power Association, Inc., 3333 N. Mayfair Rd., Milwaukee, WI 53222-3219.

<sup>17</sup> Available from Grünenthaler Strasse 40d, 57072 Aachen, Germany.

<sup>18</sup> Available from Society of Automotive Engineers (SAE), 400 Commonwealth Dr., Warrendale, PA 15096-0001.

<sup>19</sup> Available from Underwriters Laboratories (UL), Corporate Progress, 333 Pfingsten Rd., Northbrook, IL 60062.

3.1.24 *restraint*—the system, device, or characteristic that is intended to inhibit or restrict the movement of the patron(s) while on the amusement ride or device.

3.1.25 *safety related control system*—the hardware and software that controls the safety functions and components of the amusement ride or device as defined by the Ride Analysis.

3.1.26 *service proven*—An amusement ride, device, or major modification to an amusement ride or device of which (1) unit(s) have been in service to the public for a minimum of five years, and (2) unit(s) that have been in service have done so without any significant design related failures or significant design related safety issues that have not been mitigated.

**4. Significance and Use**

4.1 The purpose of this practice is to provide designers, engineers, manufacturers, owners, and operators with criteria and references for use in designing amusement rides and devices or a major modification for amusement rides or devices.

**5. General Design Criteria**

5.1 *Ride Analysis:*

5.1.1 The manufacturer shall perform a ride analysis that shall include the following:

5.1.1.1 *Patron Restraint and Containment Analysis*—A patron restraint and containment analysis shall be performed in accordance with Section 6.

5.1.1.2 *Patron Clearance Envelope Analysis*—A patron clearance envelope analysis shall be performed in accordance with Section 6.

5.1.1.3 *Failure Analysis*—A failure analysis shall be performed on the safety related systems of the amusement ride or device. The failure analysis shall include either a Fault Tree Analysis, a Failure Mode and Effects Analysis (FMEA), or other accepted engineering practices.

5.1.2 The ride analysis shall specifically include an assessment of the suitability of the design of the amusement ride or device for the intended patrons, including anthropomorphic factors that relate age and physical size.

5.1.3 The ride analysis shall identify the most significant factors that may affect patron safety and shall include mitigation for each factor.

5.1.4 The ride analysis shall be documented listing the safety issues that were identified and the means used to mitigate each issue.

5.2 *Design and Calculations:*

5.2.1 The designer/engineer shall perform calculations showing compliance with the design criteria of this practice. Calculations and assessments of the following types are required.

5.2.1.1 Calculations verifying the adequacy of structural, mechanical, and electrical components.

5.2.1.2 Calculations of significant and predictable acceleration that is generated by the ride or device when operated as reflected in the manufacturer’s provided operating and maintenance manuals or written instructions.

5.2.1.3 Performance and functional characteristics of control systems.

5.2.1.4 Calculations shall be performed using coordinate axis and load paths as defined by Practice F 2137 or the EN equivalent.

5.3 *Units:*

5.3.1 Units of measurement shall be clearly specified in all documentation.

5.3.2 The coordinate system shown in Fig. 1 shall be used as the standard reference for acceleration directions, including the application of the different means of restraint in accordance with the criteria of the restraint diagram shown in Fig. 2.

5.4 *Drawings and Records:*

5.4.1 The designer/engineer or manufacturer shall produce and retain as-built drawings, calculations, and control software that depict the amusement ride, device, or major modification details. These drawings and calculations shall be retained for a minimum of 20 years from the date of last manufacture. In the case of a major modification, only the records associated with that major modification, and not the entire ride or device, must be retained for a minimum of 20 years.

5.4.2 Documents deemed proprietary and confidential by the manufacturer shall include a statement of such on each document. Use of the manufacturer’s documentation and records should be limited, where possible, to the installation, maintenance, inspection, and operation of the ride or device. All other dissemination should be limited.

5.4.3 Documentation supplied to the buyer, owner, or operator shall be complete and adequate for proper installation, maintenance, inspection, and operation of the amusement ride, device, or major modification.

5.4.4 Drawings and documents shall illustrate and define all important dimensions and tolerances. Dimensions, tolerances, and other important characteristics shall be clearly depicted in appropriate views and cross sections. The following shall be included:

5.4.4.1 General drawings or diagrams in plan, elevation, and section views showing the general arrangement of components, including patron clearance envelope as described in Section 6 of this practice.

5.4.4.2 Assembly and subassembly drawings providing additional views of areas not clearly discernible from the general

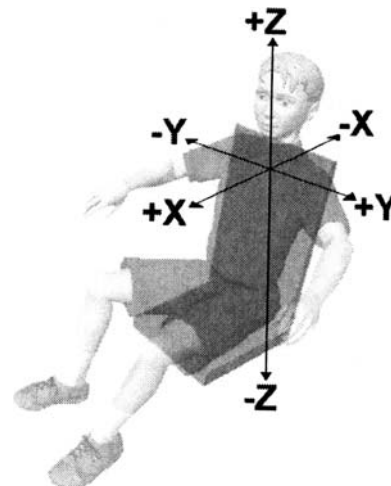
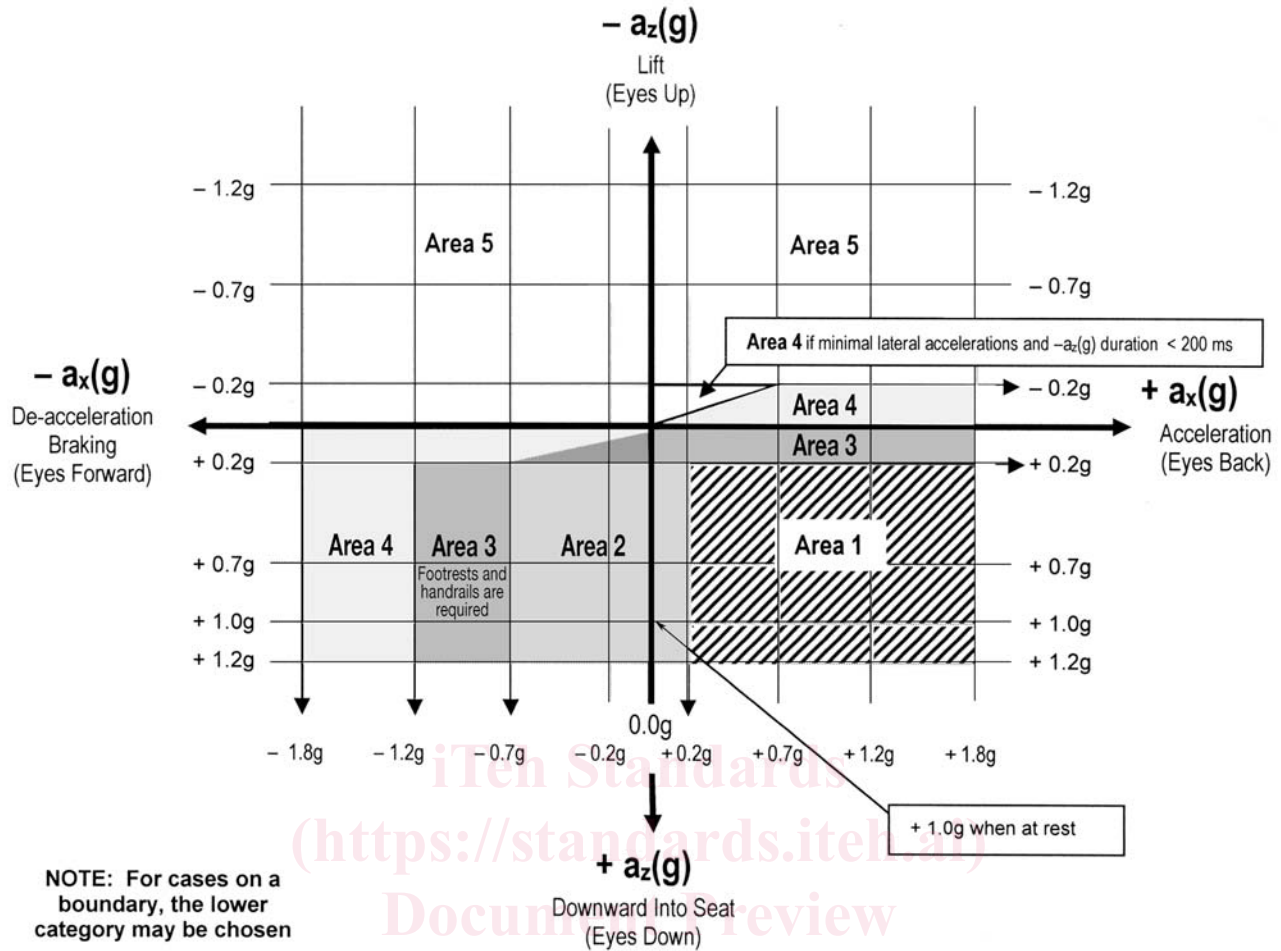

FIG. 1 Patron Containment Area Acceleration Coordinate Axes



Distinctive Areas 1 through 5

FIG. 2 Restraint Determination Diagram—Accelerations in Design Stage

<https://standards.iteh.ai/catalog/standards/sist/5aba13d2-b391-4b9d-8842-b9bdc03553a4/astm-f2291-04>

drawings and providing clear identification and specification of all included components, their locations, and other information as applicable, for example, proper adjustment(s), fastener tightening specifications, descriptions of any other materials or lubricants used, and other important information.

5.4.4.3 Detailed drawings of all components specifically manufactured for use in the amusement ride, device, or major modification.

5.5 Regulatory Body Review Documents:

5.5.1 When the approval of the amusement ride, device, or major modification design is required by a regulatory authority, the following documents are typically made available for review:

5.5.1.1 General assembly drawings,

5.5.1.2 Facility interface drawings and related load calculations,

5.5.1.3 Operations, maintenance, and assembly instructions, and

5.5.1.4 Information otherwise called for in accordance with the guidelines in Specification F 698, Practice F 770, and Practice F 853.

5.5.2 Use of the manufacturer's documentation and records should be limited to the regulatory approval process and

dissemination shall be limited to minimize disclosure of proprietary and confidential documents.

6. Patron Restraint, Clearance Envelope, and Containment Design Criteria

6.1 Patron Containment:

6.1.1 The amusement ride or device shall be designed to support and contain the patron(s) during operation. This support and containment shall be consistent with the intended action of the ride or device.

6.1.2 Parts of amusement rides and devices that patrons may reasonably be expected to contact shall be smooth; free from unprotected protruding studs, bolts, screws, sharp edges and corners, and rough or splintered surfaces; and considered for padding as appropriate.

6.1.3 Ride or Device Vehicle Doors:

6.1.3.1 When amusement ride or device patron vehicles are provided with doors, measures shall be taken to ensure that the doors do not open during operation, failure, or in case of emergency, unless otherwise determined by the ride analysis.

6.1.3.2 Powered doors shall be designed to minimize pinch points and entrapment areas. The doors' (opening and closing) movement shall be controlled, and the maximum exerted force,

measured on the edge of the door at the furthestmost point from the hinge or pivot, shall not exceed 30 lb (133 N).

## 6.2 Security of Patron Containment System:

6.2.1 Any system or systems used to support and contain the patron(s) shall be securely fixed to the structure of the ride or device and shall have adequate strength for the intended forces produced by the ride or device and the reasonably foreseeable actions of the patron(s).

## 6.3 Patron Restraints:

6.3.1 Patron restraints shall be provided as determined by the designer/engineer. This determination shall be based on the patron restraint and containment analysis performed in accordance with criteria defined in this practice and shall take into consideration the nature of the amusement ride or device and the intended adult or child patron physical characteristics, based on anthropomorphic data such as Dreyfuss Human Scale 4/5/6 (**1<sup>20</sup>**), 7/8/9 (**2**), or SAE J-833, and Center for Disease Control Growth Charts.

6.3.2 Restraint devices shall be provided in cases where it is reasonably foreseeable that patrons could be lifted or ejected from their seats or riding positions by the acceleration of the amusement ride or device, or by seat inclination, during the ride or device cycle and other reasonably foreseeable situations, for example, the application of emergency brakes or vehicles stopped in inverted positions.

6.3.3 Where kiddie rides or devices do not provide fully enclosed compartment (that is, so as to reject a 4 in. diameter sphere at all openings), a latching restraint shall be provided unless the patron restraint and containment analysis indicates a locking restraint is needed or a restraint is not appropriate (for example, a kiddie canoe ride).

6.3.3.1 Where kiddie rides or devices provide either latching or locking restraints, the final latching or locking position of the restraint must be adjustable in relation to the patron(s).

6.3.4 The patron restraint and containment analysis may identify the need for a restraint system for reasons other than acceleration or seat inclination. The analysis shall also evaluate the need for locking or latching functions when restraints are required.

6.3.5 A manual restraint release shall be provided for authorized personnel use.

6.3.5.1 The manual release should be conveniently located and easily accessed by authorized personnel without crawling over or under or otherwise coming in direct contact with the patrons.

6.3.5.2 External or unmonitored internal nonmechanical stored energy, for example, battery, accumulator, hydraulic, or pneumatic, shall not be used for a manual release unless otherwise determined by the ride analysis.

6.3.5.3 Special tools shall not be required to operate the manual release, unless otherwise determined by the ride analysis.

6.3.6 The manufacturer shall take into consideration the evacuation of patrons from any reasonably foreseeable position or situation on the ride or device, including emergency stops

and stops in unplanned locations. The patron restraint and containment analysis shall address whether individual or group restraints releases are appropriate.

6.3.7 The manufacturer shall specify the state, locked or unlocked, of the restraint system in the event of unintended stop, for example, emergency stop or loss of power. This specification shall be based on the results of the ride analysis performed in 5.1.

6.3.8 Restraints shall be designed such that the opportunity for pinching or unintentional trapping of fingers, hands, feet, and other parts of the patron's body is minimized.

6.3.9 The maximum exerted force produced by any powered patron restraint device while opening or closing shall not be more than 18 lb (0.08 kN), measured on the active surfaces contacting the patron. Force limiting systems, if used to achieve this, shall be configured so that the failure of any one element of that system will still result in force being limited to 18 lb (0.08 kN).

6.3.10 The manufacturer shall take into account the patron-induced loads, for example, bracing, etc., in addition to the loads and criteria specified in the Loads and Strengths section of this practice.

6.3.11 The physical information provided in accordance with Specification F 698 shall be consistent with the patron restraint system, if any.

## 6.4 Restraint Configuration:

6.4.1 The restraint diagram shown in Fig. 2 shall be used as part the patron restraint and containment analysis for determining if a restraint is required, and if required, what type. The restraint diagram identifies and graphically illustrates five distinctive areas of theoretical acceleration. Each of the five distinctive areas may require a different class of restraint as indicated in 6.5 of this practice. The restraint diagram applies for "sustained acceleration" levels only. It is not to be applied for "impact acceleration."

6.4.2 The application of the restraint diagram is intended as a design guide. The ride analysis or other factors or requirements of this practice may indicate the need to consider another class of restraint (either higher or lower). Any special situation needs to be taken into consideration in designing the restraint system. These may include:

6.4.2.1 Duration and magnitude of the acceleration,

6.4.2.2 Height of the patron-carrying device above grade or other objects,

6.4.2.3 Wind effects,

6.4.2.4 Unexpected stopping positions of the patron units, for example, upside down,

6.4.2.5 Lateral accelerations, for example, where sustained lateral accelerations are equal to or greater than 0.5 G, special consideration shall be given to the design of seats, backrest, headrest, padding, and restraints, and

6.4.2.6 The intended nature of the amusement ride or device.

6.5 *Restraint Criteria*—Referring to areas on the restraint determination diagram shown in Fig. 2, as a minimum, the following restraint classes shall be used (in all areas, a higher class restraint device or individual requirements of a higher class restraint device may be used):

<sup>20</sup> The boldface numbers in parentheses refer to the list of references at the end of this standard.

6.5.1 *Area-1*—A Class-1 restraint is required.

6.5.1.1 A Class-1 restraint device is defined as unrestrained or no restraint at all.

6.5.1.2 Based solely on Area-1 dynamic forces, no restraint is required; however, other criteria in this practice (that is, the ride analysis) may require a higher class restraint device.

6.5.2 *Area-2*—A Class-2 restraint is required unless patrons are provided sufficient support and the means to react to the forces, for example, handrails, footrest or other devices. A Class-2 restraint device shall have at least the following:

6.5.2.1 *Number of Patrons Per Restraint Device*—The restraint device may be for an individual patron or it may be a collective device for more than one patron.

6.5.2.2 *Final Latching Position Relative to the Patron*—The final latching position may be fixed or variable in relation to the patron.

6.5.2.3 *Type of Latching*—The patron or operator may latch the restraint.

6.5.2.4 *Type of Unlatching*—The patron or operator may unlatch the restraint.

6.5.2.5 *Type of External Correct or Incorrect Indication*—No indication is required.

6.5.2.6 *Means of Activation*—The restraint may be manually or automatically (for example, motorized) opened and closed.

6.5.2.7 *Redundancy of Latching Device*—A redundant design is not required.

6.5.3 *Area-3*—A Class-3 restraint is required. A Class-3 restraint device shall have at least the following:

6.5.3.1 *Number of Patrons per Restraint Device*—The restraint device may be for an individual patron or it may be a collective device for more than one patron.

6.5.3.2 *Final Latching Position Relative to the Patron*—The final latching position must be variable in relation to the patron, for example, a bar or a rail with multiple latching positions.

6.5.3.3 *Type of Latching*—The restraint device may be manually or automatically latched. The manufacturer shall provide instructions that the operator shall verify the restraint device is latched.

6.5.3.4 *Type of Unlatching*—The patron may manually unlatch the restraint or the operator may manually or automatically unlatch the restraint.

6.5.3.5 *Type of External Correct or Incorrect Indication*—No external indication is required. The design shall allow the operator to perform a visual or manual check of the restraint each ride cycle.

6.5.3.6 *Means of Activation*—The restraint may be manually or automatically (for example, motorized) opened and closed.

6.5.3.7 *Redundancy of Latching Device*—A redundant design is not required.

6.5.4 *Area-4*—A Class-4 restraint is required. A Class-4 restraint device shall have at least the following:

6.5.4.1 *Number of Patrons per Restraint Device*—A restraint device shall be provided for each Individual patron.

6.5.4.2 *Final Latching Position Relative to the Patron*—The final latching position of the restraint must be variable in relation to the patrons, for example, a bar or a rail with multiple latching positions.

6.5.4.3 *Type of Locking*—The restraint device shall be automatically locked.

6.5.4.4 *Type of Unlocking*—Only the operator shall manually or automatically unlock the restraint.

6.5.4.5 *Type of External Correct or Incorrect Indication*—No external indication is required. The design shall allow the operator to perform a visual or manual check of the restraint each ride cycle.

6.5.4.6 *Means of Activation*—The restraint may be manually or automatically (for example, motorized) opened or closed.

6.5.4.7 *Redundancy of Locking Device*—Redundant design shall be provided for the locking device function.

6.5.5 *Area-5*—A Class-5 restraint is required. A Class-5 restraint shall have at least the following:

6.5.5.1 *Number of Patrons per Restraint Device*—A restraint device shall be provided for each individual patron.

6.5.5.2 *Final Latching Position Relative to the Patron*—The final latching position of the restraint must be variable in relation to the patrons, for example, a bar or a rail with multiple latching positions.

6.5.5.3 *Type of Locking*—The restraint device shall be automatically locked.

6.5.5.4 *Type of Unlocking*—Only the operator shall manually or automatically unlock the restraint.

6.5.5.5 *Type of External Correct or Incorrect Indication*—An external indication is required. Detecting the failure of any monitored device shall either bring the ride to a cycle stop or inhibit cycle start.

6.5.5.6 *Means of Activation*—The restraint may be manually or automatically (for example, motorized) opened or closed.

6.5.5.7 *Redundancy of Locking Device*—Redundant locking device function is required.

6.5.5.8 *Restraint Configuration*—Two restraints, for example, shoulder and lap bar or one fail-safe restraint device is required.

6.5.6 *Secondary Restraints for Class 5*—A Class-5 restraint configuration may be achieved by the use of two independent restraints or one fail-safe restraint. When two independent restraints are used, the secondary restraint device shall have the following minimum characteristics:

6.5.6.1 *Number of Patrons per Restraint Device*—The restraint device may be for an individual patron or it may be a collective device for more than one patron.

6.5.6.2 *Final Latching Position Relative to the Patron*—The final latching position may be fixed or variable in relation to the patron.

6.5.6.3 *Type of Locking*—Only the operator may manually or automatically lock the restraint.

6.5.6.4 *Type of Unlocking*—Only the operator shall manually or automatically unlock the restraint.

6.5.6.5 *Type of External Correct or Incorrect Indication*—No external indication is required other than a visual check of the restraint itself.

6.5.6.6 *Means of Activation*—The restraint may be opened or closed manually or automatically (for example, motorized).

6.5.6.7 *Redundancy of Locking Device*—The actuation means of the locking device shall be redundant.

#### 6.6 *Patron Clearance Envelope Analysis:*

6.6.1 Amusement rides and devices shall be designed to provide a patron clearance envelope adequate to minimize the opportunity for contact between the patron and other objects where said contact is likely to cause injury.

6.6.2 The designer/engineer shall determine the shape and size of the required clearance envelope based on the appropriate patron model and the design of the patron containment system, if any. The minimum patron model shall be based on Dreyfuss Human Scale 4/5/6 (1), 7/8/9 (2), SAE J-833, or CDC 95th percentile, with an additional (extended) arm and leg reach of 3 in. (effectively a 99.9th percentile) male, adult or child, as appropriate. (See Section 2, Referenced Documents.) The following shall be considered:

6.6.2.1 The intended patron size and height and any designer/engineer specified restriction for minimum or maximum patron height.

6.6.2.2 The shape(s) and configuration of the patron containment system, including:

- (1) Seats, armrest, seat back and sides, foot well, or other,
- (2) Associated restraint system(s), if provided, for example, lap bar, seat belt, shoulder restraint, cage, or other, and
- (3) The ability, as limited by the patron containment, of the patron to extend any part of his or her body, for example, arms and legs, outward beyond the perimeters of the vehicle.

6.6.2.3 The physical nature of surrounding objects or surfaces that might otherwise be contacted, for example, sharp, hard, rough or abrasive, ability to snag or trap and hold, or other attributes that may produce undesirable contact for the patrons of the ride or device.

6.6.2.4 The relative speeds and directions that contact might take place.

6.6.2.5 The reasonably foreseeable changes that are likely to occur in the location or nature of the surroundings, for example, other adjacent moving vehicles or objects and their physical nature and speeds.

6.6.2.6 The possibility of variations in the position or orientation of the patron carrying device, (for example, angular movement, side movement, unrestrained or undamped motion, or free swinging).

6.6.3 The patron clearance envelope analysis shall be in accordance with 6.6.2. These formats and the following definitions may be used as a guideline for determining minimum patron clearance envelope for amusement rides and devices.

6.6.3.1 The reach distance shall be the maximum reach, limited only by the vehicle and seat geometry and restraint system. The possibility of a patron extending arms or legs through vehicle openings or beyond the reasonably foreseeable reach shall be considered. The ride analysis performed in accordance with 5.1 may modify these requirements.

6.6.3.2 Where the design of an amusement ride or device allows contact within the clearance envelope between patrons and surrounding surfaces or objects, the manufacturer shall take reasonably appropriate measures to ensure that those surfaces or objects are configured to avoid hostile features such as splinters, sharp or sharply angled features or edges, protruding items, pinch points, or entrapment areas. This requirement is especially important in a ride or device load/unload area where patron control and assistance devices are provided.

6.6.3.3 When the design of an amusement ride and device allows patron-to-patron contact (for example, while seated in separate vehicles), the designer/engineer shall take reasonably appropriate steps to insure that the potential contact is appropriate for the amusement ride or device's intended use and the intended patron experience.

6.6.4 The designer/engineer or manufacturer shall determine a means by which direct measurement may be taken to confirm that the intended patron clearance envelope is attained in the completed amusement ride or device assembled in its operating location.

6.6.4.1 The determined means shall include points from which measurements may be taken. The locations of these points shall be illustrated with appropriate drawings in the manufacturer provided instructions or they may be physical markers on the amusement ride or device.

6.6.4.2 The determined means and clearance distances shall be shown in a convenient form and illustrated both graphically and numerically. Illustrations similar to Figs. 3 and 4 are one acceptable method.

6.6.5 Any moveable system or device designed to encroach on the clearance envelope, that is, loading/unloading platforms, decks, or other devices, shall be designed in a fail-safe manner in order to prevent undesirable contact.

6.7 *Signage*—The manufacturer shall determine and may make recommendations for appropriate advisory signs or warning signs based on the attributes of the amusement ride or device. These recommendations should be clear and concise but are not intended to be the final wording of the signs that may be generated and displayed at the ride or device.

## 7. Acceleration Limits

### 7.1 *Acceleration Limits:*

7.1.1 Amusement rides and devices shall be designed such that the ride dynamics, when measured as provided herein, are within the limits specified in this practice. Test data intended for evaluation against the limits specified in this practice shall be acquired and prepared as follows:

7.1.1.1 The data shall be acquired in accordance with the provisions of the Standard Amusement Ride Characterization (SARC) test, as specified in Section 12 of Practice F 2137

7.1.1.2 The acquired SARC test data shall be post-processed, with a 4-pole, single pass, Butterworth low pass filter using a corner frequency ( $F_c$ ) of 5 Hz.

7.1.2 Amusement rides and devices or major modifications that are designed to operate outside the acceleration limits herein shall include justification in the ride analysis. The justification shall include a review by a biodynamic expert.

7.1.3 Acceleration can vary greatly depending on the type and design of the amusement ride or device, and the effect of



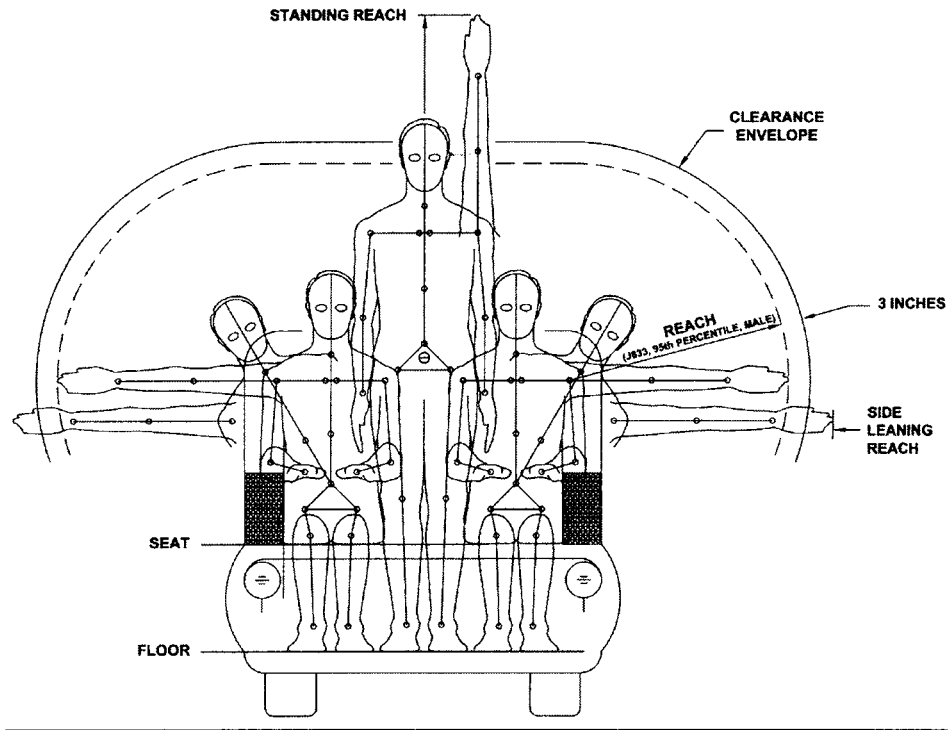

FIG. 3 Sample Patron Clearance Envelope—Front View

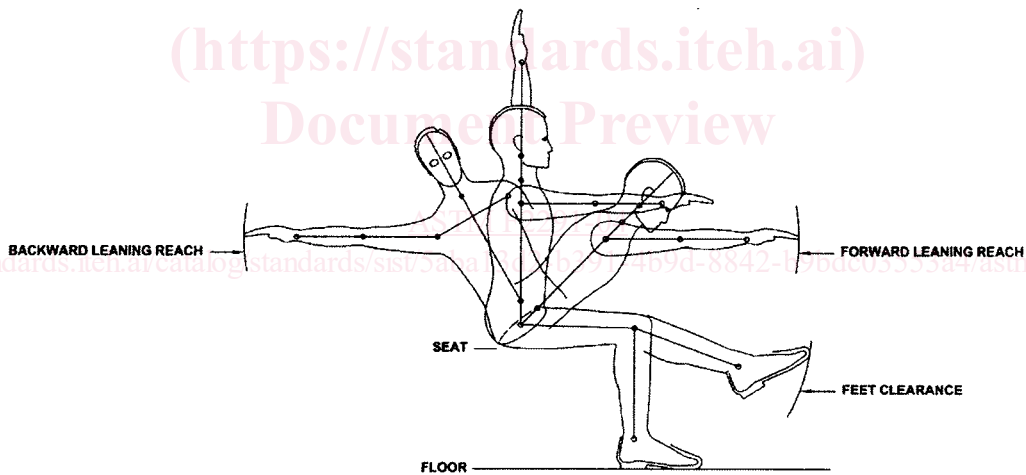

FIG. 4 Sample Patron Clearance Envelope—Side View

these accelerations is dependent on many factors that may be considered in the design (see Appendix X2). Accelerations shall be coordinated with the intended physical orientation of the patron during the operating cycle. Rides and devices with patron containment systems shall be designed such that the patron is suitably contained and positioned to accept these accelerations. The patron restraint and containment analysis shall consider cases related to patron position within the restraint as determined by the designer/engineer. Fig. 1 illustrates the coordinate system utilized.

7.1.4 Sustained acceleration limits are shown in this section (see Figs. 5-9). The following definitions apply:

7.1.4.1 Acceleration units are “G” (32.2 ft/s/s or 9.81 m/s/s).

7.1.4.2 Impacts of less than 200 ms duration are not addressed by this practice.

7.1.4.3 Acceleration limits herein are for patrons 48 in. in height and above. The designer/engineer shall determine whether more restrictive limits are appropriate for an amusement ride or device that accommodates patrons under 48 in. in height. In making this determination, the designer/engineer shall consider biodynamic effects on the patrons. If an amusement ride, device, or major modification that accommodates patrons under 48 in. in height is designed to operate outside the acceleration limits herein, the ride analysis must include a review by a biodynamic expert.

7.1.4.4 Because of insufficient data, the suitability of the acceleration limits herein for disabled patrons must be addressed on an individual basis.

7.1.4.5 The limits specified for all axes are for total net acceleration, inclusive of earth’s gravity. A motionless body

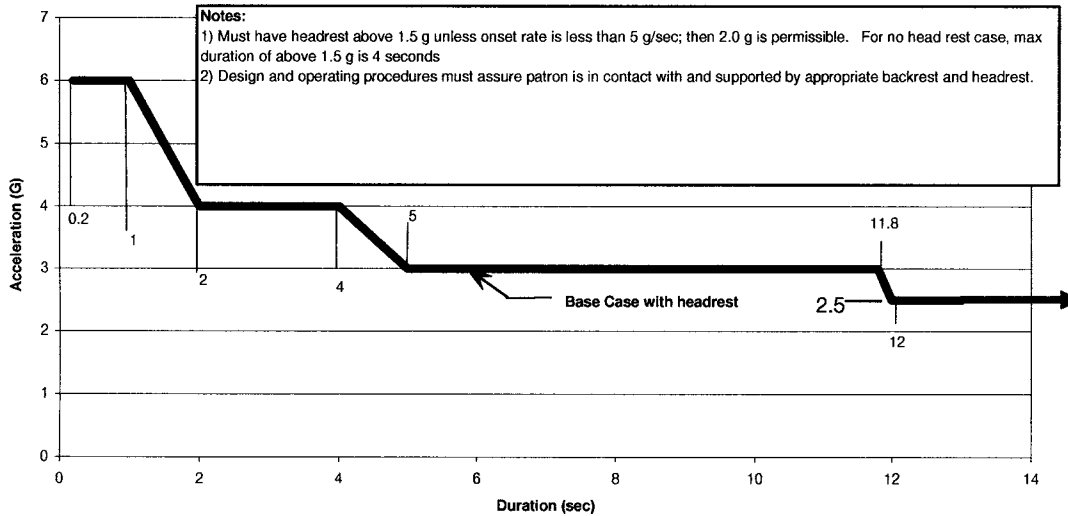

FIG. 5 Time Duration Limits for +Gx (Eyes Back)

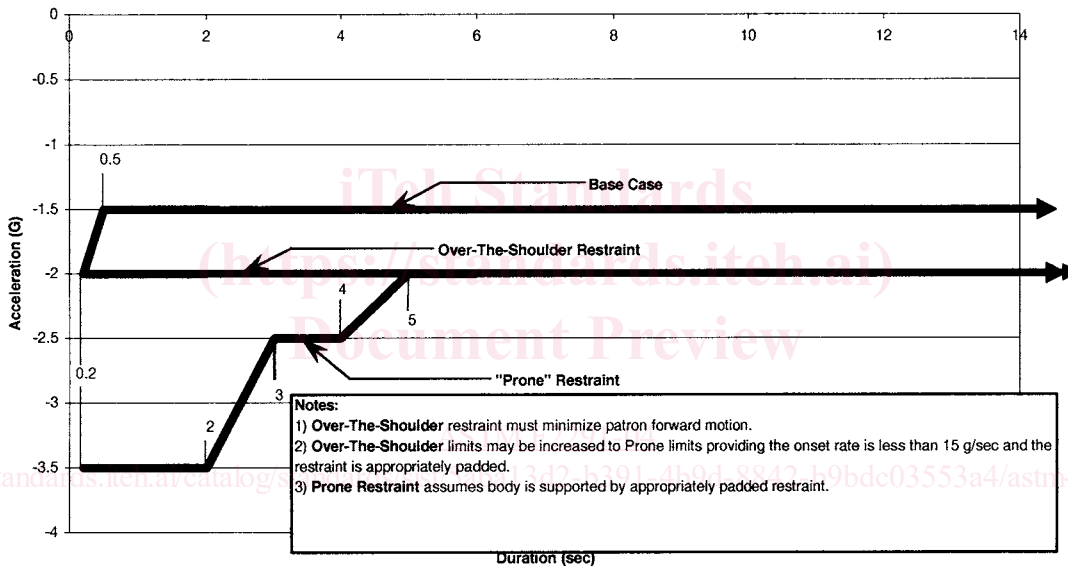

FIG. 6 Time Duration Limits for -Gx (Eyes Front)

would therefore have a magnitude of 1 G measured in the axis perpendicular to the earth's surface, and a zero G magnitude in the axes parallel to the earth's surface.

7.1.4.6 Steady state values in the charts are not limited in time unless otherwise specified. Sustained exposure in excess of 90 s has not been addressed by this practice.

7.1.4.7 These limits are provided for the following basic restraints types:

(1) *Base Case (Class-4 or -5 Restraint)*—For the purpose of acceleration limits the Class-4 restraint used as the base case herein also provides support to the lower body in all directions and maintains patron contact with the seat at all times.

(2) *Over-the-Shoulder (Class-5 Restraint)*

(3) *Prone Restraint*—A prone restraint is one in which the patron is oriented face down at a point or points during the ride cycle. A prone restraint is a restraint designed to allow the patron to accept higher acceleration in the -Gx (eyes front) as compared to the base case and over-the-shoulder restraints.

NOTE 1—The patron restraint and containment analysis shall be used to

determine the type of restraint. The type and performance of the restraint system selected may require a reduction in the acceleration limit.

7.1.5 Simultaneous combinations of single axis accelerations shall be limited as follows:

7.1.5.1 The instantaneous combined acceleration magnitude of any two axes shall be limited by a curve that is defined in each quadrant by an ellipse. The ellipse is centered at (0,0) and is characterized by major and minor radii equal to the allowable 200 ms G limits  $\times 1.1$ . Graphical representations of this requirement are presented in Figs. 10-17. Note that for a given ride, only three of the curves will apply.

7.1.6 Reversals in X and Y accelerations are shown in Fig. 18. The following criteria shall apply:

7.1.6.1 The peak-to-peak transition time between consecutive sustained events in X and Y accelerations shall be greater than 200 ms, as measured by the time between the peaks of the consecutive events. When the elapsed time between consecutive sustained events is less than 200 ms, the limit for the peak values shall be reduced by 50 %.

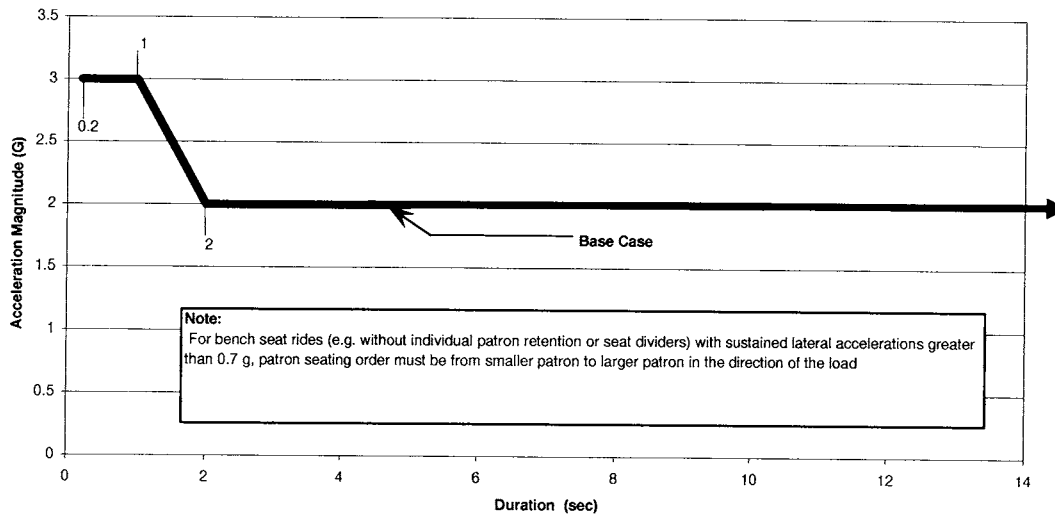

FIG. 7 Time Duration Limits for ±Gy (Eyes Left or Eyes Right)

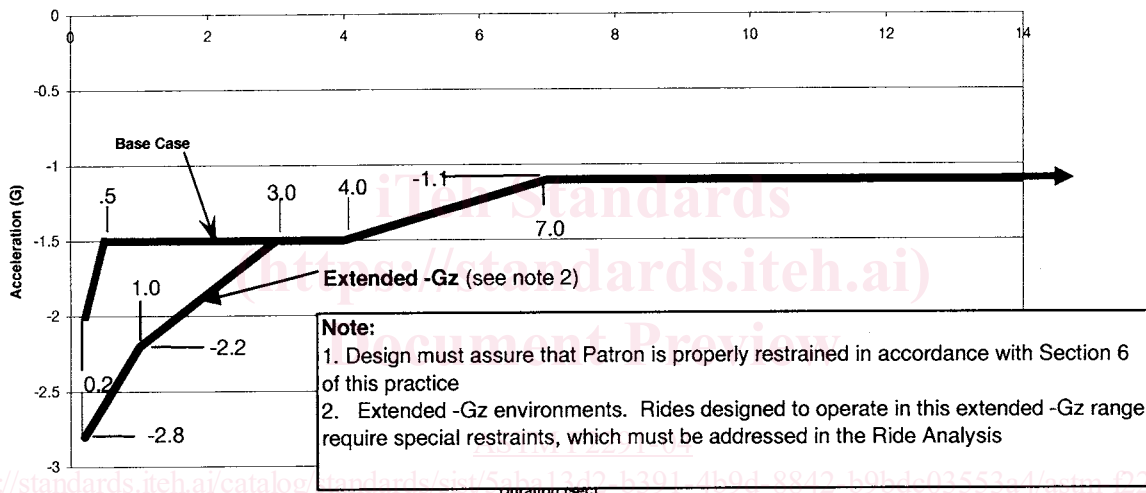

FIG. 8 Time Duration Limits for -Gz (Eyes Up)

7.1.6.2 The following examples illustrate such reversal:

7.1.7 Transitions in Z:

7.1.7.1 Transition directly from negative (eyes up) limits to positive (eyes down) limits is restricted. If Patrons are exposed to a negative Gz environment for more than 3 s, then the limits are reduced as shown in the +Gz limit chart for 6 s after the transition to positive Gz. After the 6 s period, the limits may be increased to the normal chart levels.

7.1.7.2 Other transitions in Z accelerations are shown in Fig. 19. The following criteria shall apply: When transitioning from sustained weightless (0 G) and more negative levels to 2 G and more positive levels, the effective onset of positive G shall be less than 15 G/s. Fig. 19 illustrates such transitions.

7.1.8 Measurement and analysis of acceleration on amusement rides and devices shall be performed in accordance with Practice F 2137. The design acceleration levels of the final operational assembly of a newly developed amusement ride, device, or major modification shall be verified at commissioning. The manufacturer may verify acceleration limits herein by

using either manual (for example, graphic, hand calculations, etc.) or automatic (for example, computational, computer, etc.) procedures.

8. Loads and Strengths

8.1 Overview:

8.1.1 This section defines the loads and strengths criteria that shall be applied in the process of design for amusement rides and devices and in the process of design for major modifications made to amusement rides and devices. This criteria is specifically intended for use in determining the loads and strengths of materials, and in performing the calculations and analyses used in the process of design.

8.2 General:

8.2.1 Amusement rides and devices shall be designed so that load conditions expected during operation shall not cause failures during the operational hours used in the design per 8.3 and 8.4.

8.2.1.1 In general, amusement rides and devices shall be designed so the expected loading conditions will not cause

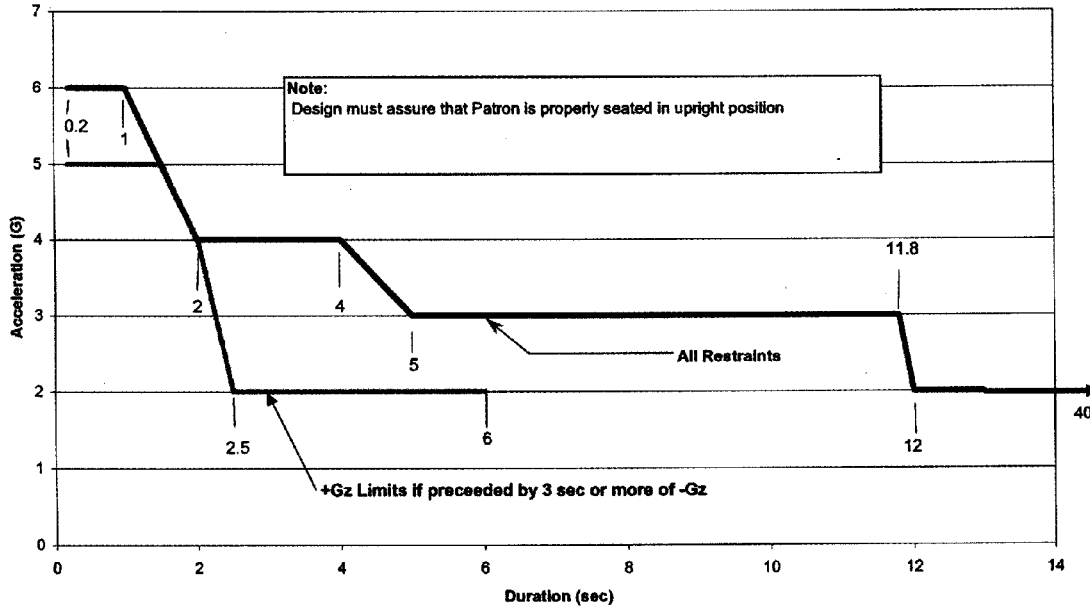

FIG. 9 Time Duration Limits for +Gz (Eyes Down)

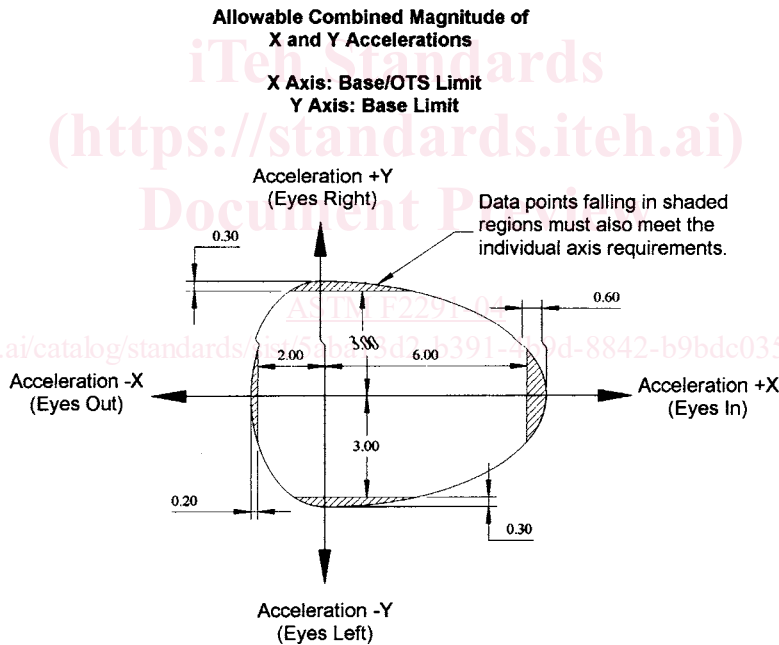

FIG. 10 Allowable Combined Magnitude of X and Y Accelerations

stresses to exceed the yield strength of the materials (that is, no significant plastic deformation should occur when structures and components are subjected to expected loads). One exception to this generality is that when designed for seismic loads, seismic design allows for the possibility of plastic deformation and relies on connection ductility to absorb energy.

8.2.1.2 A possible exception to 8.2.1 may be made in the case of components and portions of structures that are intended to provide secondary load paths during a failure condition (not to be interpreted as an emergency-stop event). Components such as safety cables or links and certain limited portions of the

primary structure that they are attached to, may be designed to yield (and thus absorb a significant amount of energy) when subjected to load conditions expected to occur during a plausible, although unlikely primary structure failure scenario. In such cases, the expected failure mode loading shall not cause rupture to occur (that is, the stresses shall not exceed the ultimate strength). Designs that rely on such criteria shall utilize materials that possess high elongation for components where stresses may be expected to exceed the yield strength under failure mode loading conditions.

8.3 35 000 Operational Hour Criteria: