



Designation: E1942 – 98 (Reapproved 2004)

Standard Guide for Evaluating Data Acquisition Systems Used in Cyclic Fatigue and Fracture Mechanics Testing¹

This standard is issued under the fixed designation E1942; the number immediately following the designation indicates the year of original adoption or, in the case of revision, the year of last revision. A number in parentheses indicates the year of last reapproval. A superscript epsilon (ϵ) indicates an editorial change since the last revision or reapproval.

1. Scope

1.1 This guide covers how to understand and minimize the errors associated with data acquisition in fatigue and fracture mechanics testing equipment. This guide is not intended to be used instead of certified traceable calibration or verification of data acquisition systems when such certification is required. It does not cover static load verification, for which the user is referred to the current revision of Practices E4, or static extensometer verification, for which the user is referred to the current revision of Practice E83. The user is also referred to Practice E467.

1.2 The output of the fatigue and fracture mechanics data acquisition systems described in this guide is essentially a stream of digital data. Such digital data may be considered to be divided into two types—Basic Data, which are a sequence of digital samples of an equivalent analog waveform representing the output of transducers connected to the specimen under test, and Derived Data, which are digital values obtained from the Basic Data by application of appropriate computational algorithms. The purpose of this guide is to provide methods that give confidence that such Basic and Derived Data describe the properties of the material adequately. It does this by setting minimum or maximum targets for key system parameters, suggesting how to measure these parameters if their actual values are not known.

2. Referenced Documents

2.1 ASTM Standards:²

E4 Practices for Force Verification of Testing Machines

E83 Practice for Verification and Classification of Extensometer Systems

¹ This guide is under the jurisdiction of ASTM Committee E08 on Fatigue and Fracture and is the direct responsibility of Subcommittee E08.03 on Advanced Apparatus and Techniques.

Current edition approved May 1, 2004. Published June 2004. Originally approved in 1998. Last previous edition approved in 1998 as E1942 - 98^{ε1}. DOI: 10.1520/E1942-98R04.

² For referenced ASTM standards, visit the ASTM website, www.astm.org, or contact ASTM Customer Service at service@astm.org. For *Annual Book of ASTM Standards* volume information, refer to the standard's Document Summary page on the ASTM website.

E467 Practice for Verification of Constant Amplitude Dynamic Forces in an Axial Fatigue Testing System

E1823 Terminology Relating to Fatigue and Fracture Testing

3. Terminology

3.1 Definitions:

3.1.1 *bandwidth* [T^1]*—*the frequency at which the amplitude response of the channel has fallen to $1/\sqrt{2}$ of its value at low frequency.

3.1.1.1 *Discussion—*This definition assumes the sensor channel response is low-pass, as in most materials testing. An illustration of bandwidth is shown in Fig. 1.

3.1.2 *Basic Data sample—*the sampled value of a sensor waveform taken at fixed time intervals. Each sample represents the actual sensor value at that instant of time.

3.1.2.1 *Discussion—*Fig. 2 shows examples of Basic Data samples.

3.1.3 *data rate* [T^1]*—*the data rate is $1/t_d$ Hertz where the time intervals between samples is t_d in seconds.

3.1.3.1 *Discussion—*The data rate is the number of data samples per second made available to the user, assuming the rate is constant.

3.1.4 *Derived Data—*any waveform parameter which is derived from one or several of the Basic Data samples.

3.1.4.1 *Discussion—*Fig. 2 illustrates examples of Derived Data.

3.1.5 *noise level—*the standard deviation of the data samples of noise in the transducer channel, expressed in the units appropriate to that channel.

3.1.6 *peak—*the point of maximum load in constant amplitude loading (see Terminology E1823).

3.1.7 *phase difference* [$^\circ$]*—*the angle in degrees separating corresponding parts of two waveforms (such as peaks), where one complete cycle represents 360° .

3.1.7.1 *Discussion—*The phase difference of a cyclic waveform only has meaning in reference to a second cyclic waveform of the same frequency.

3.1.8 *sampling rate* [T^1]*—*the rate at which the analog-to-digital converter samples a waveform. This rate may not be visible to the user of the data acquisition system.

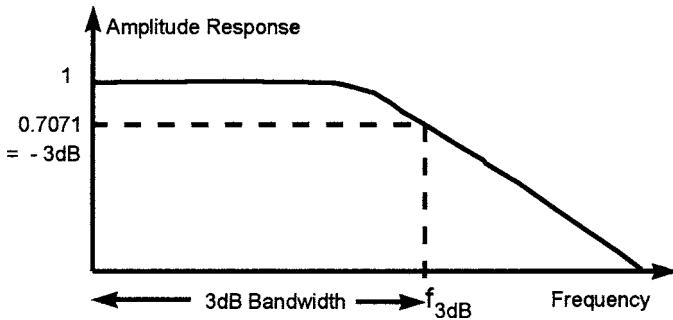

FIG. 1 3-dB Bandwidth of Sensor Channel

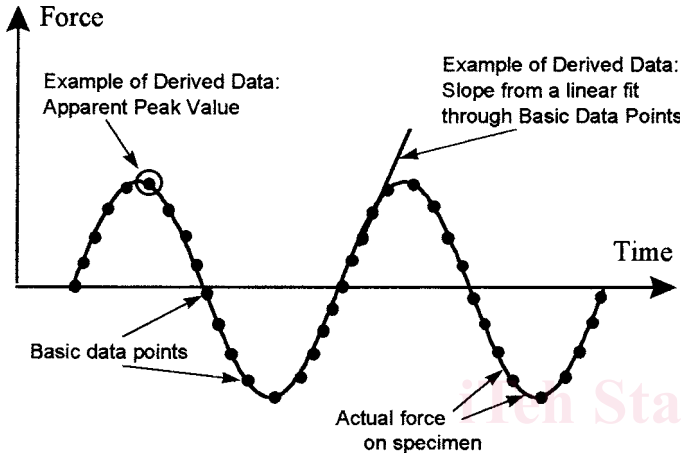

FIG. 2 Basic and Derived Data

3.1.8.1 *Discussion*—A distinction is made here between *sampling rate* and *data rate*, because in some data acquisition systems, the analog waveform may be sampled at a much higher rate than the rate at which data are made available to the user. (Such a technique is commonly known as *over-sampling*).

3.1.9 *word size*—the number of significant bits in a single data sample.

3.1.9.1 *Discussion*—The word size is one parameter which determines the system resolution. Usually it will be determined by the analog-digital converter used, and typically may be 12 or 16 bits. If the word size is w , then the smallest step change in the data that can be seen is 1 part in 2^w , that is the *quantization step* is $d = 2^{-w}$.

3.1.10 *valley*—The point of minimum load in constant amplitude loading (see Terminology E1823).

4. Description of a Basic Data Acquisition System

4.1 In its most basic form, a mechanical testing system consists of a test frame with grips which attach to a test specimen, a method of applying forces to the specimen, and a number of transducers which measure the forces and displacements applied to the specimen (see Fig. 3). The output from these transducers may be in digital or analog form, but if they are analog, they are first amplified and filtered and then converted to digital form using analog-to-digital converters (ADCs). The resulting stream of digital data may be digitally filtered and manipulated to result in a stream of output Basic Data which is presented to the user in the form of a displayed or printed output, or as a data file in a computer. Various

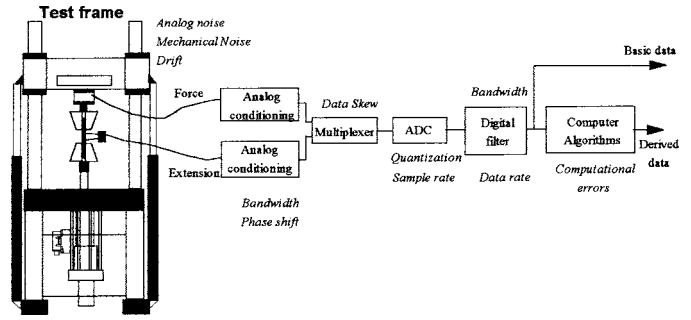

FIG. 3 Sources of Error in Data Acquisition Systems

algorithms may be applied to the Basic Data to derive parameters representing, for example, the peaks and valleys of the forces and displacements applied to the specimen, or the stresses and strains applied to the specimen and so forth. Such parameters are the Derived Data.

4.1.1 The whole measurement system may be divided into three sections for the purpose of verification: the mechanical test frame and its components, the electrical measurement system, and the computer processing of data. This guide is specifically concerned only with the electrical measurement system commencing at the output of the transducers. Before the mechanical system is investigated for dynamic errors by the methods given in Practice E467, this guide can be used to ascertain that the electrical measurement system has adequate performance for the measurements required for Practice E467. If the requirements of Practice E467 for the mechanical system and the recommendations of this guide are met, then the user has confidence that the Basic Data produced by the testing system are adequate for processing by subsequent computer algorithms to produce further Derived Data.

4.1.2 At each stage of the flow of data in the electrical measurement system, errors can be introduced. These should be considered in the sequence in which these are dealt with in this guide. The sequence includes:

4.2 *Errors Due to Bandwidth Limitations in the Signal Conditioning*—Where there is analog signal conditioning prior to analog-to-digital conversion, there will usually be restrictions on the analog *bandwidth* in order to minimize noise and, in some cases, to eliminate products of demodulation. After digital conversion, additional digital filtering may be applied to reduce noise components. These bandwidth restrictions result in cyclic signals at higher frequencies having an apparent amplitude which is lower than the true value, and if the waveform is not sinusoidal, also having waveform distortion. The bandwidth restrictions also cause *phase shifts* which result in phase measurement errors when comparing phase in two channels with different bandwidths.

4.3 *Errors Due to Incorrect Data Rate*—Errors can result from an insufficient *data rate*, where the intervals between data samples are too large and intervening events are not recorded in the Basic Data. These result also in errors in the Derived Data, for example, when the peak value of a waveform is missed during sampling. *Data skew*, where the Basic Data are not acquired at the same instant in time, can produce similar errors to phase shifts between channels.

4.4 *Errors Due to Noise and Drift*—Noise added to the signal being measured causes measurement uncertainty. Short-term noise causes variability or random error, and includes *analog noise* at the transducer output due to electrical or mechanical pick up, and analog noise added in the amplifier, together with digital noise, or *quantization*, due to the finite digital word length of the ADC system.

4.4.1 Long-term effects, such as *drifts* in the transducer output or its analog signal conditioning due to temperature or aging effects, are indistinguishable from slow changes in the forces and displacements seen by the specimen, and cause a more systematic error.

4.4.2 Further details of these sources of error are given in [Annex A1](#).

5. System Requirements

5.1 *How This Section is Organized*—This section gives the steps that must be taken to ensure the errors are controlled. There are several sources of error in the electrical system, and these may add both randomly and deterministically. To give reasonable assurance that these errors have a minor effect on overall accuracy of a system with 1 % accuracy, recommendations are given in this guide, which result in a 0.2 % error bound for each individual source of error. However, [Annex A1](#) also shows how the error varies with each parameter, so that the user may choose to use larger or smaller error bounds with appropriate adjustments to bandwidth, data rate, and so forth.

5.1.1 In this section, which is intended to be used in the order written, a minimum value or a maximum value is recommended for each parameter. If the actual value of each parameter is known, then the system requirement is that in each case either:

Maximum value \geq *actual value*

or

Minimum value \leq *actual value*.

However, if the actual value is not known, then help is given as to how to determine it.

5.2 *Frequency and Waveshape*—The first step is to determine the highest cyclic frequency, f Hz, at which testing will occur, and the waveshape to be employed (for example, sinusoidal, triangular, square).

5.3 *Minimum Bandwidth*—If the waveform is sinusoidal or square, then the minimum bandwidth is $10f$ Hz to measure the peak value. If the waveform is triangular, then the minimum bandwidth is $100f$ Hz. For example, for a 10-Hz sinusoidal waveform, the minimum bandwidth is 100 Hz. For a discussion of minimum bandwidth, see [A1.2.1](#) and [A1.2.2](#).

5.4 *Actual Bandwidth*—The actual bandwidth must be equal to or greater than the minimum bandwidth. If this condition cannot be met, then the errors will increase as shown in [A1.2.1](#) and [A1.2.2](#). If the actual bandwidth is not known, then it can be ascertained using one of the suggested methods in [A1.2.3](#), or otherwise.

5.5 *Minimum Data Rate*—For measurement of the peak value of sinusoidal or square waveforms, the minimum data rate is 50 points/cycle, or $50f$ points/s. For measurement of the peak value of triangular waveforms, the minimum data rate is 400 points/cycle, or $400f$ points/s. If the data acquisition system produces the peak value as an output, then the internal

Basic Data rate used should equal or exceed the appropriate minimum data rate (depending on waveform type). This should be verified even if the external rate at which samples are presented is less than this minimum value. For a discussion of data rate, see [A1.3.1](#).

5.6 *Actual Data Rate*—The actual data rate must equal or exceed the minimum data rate. If the actual data rate is not known, then it must be ascertained using a method such as that in [A1.3.2](#).

5.7 *Maximum Permitted Noise Level*—The noise level is the standard deviation of the noise in the transducer channel, expressed in the units appropriate to the channel. The maximum permitted noise level is 0.2 % of the expected peak value of the waveform being measured. For example, if the expected peak value in a load channel is 100 kN, then the standard deviation of the noise in that channel must not exceed 0.2 kN.

5.8 *Actual Noise Level*—The actual noise level must be equal to or less than the maximum permitted noise level. If the actual noise level is not known, then it must be ascertained using a method such as that in [A1.4.6](#). Guidance on how to investigate sources of noise is given in [A1.4.7](#).

5.8.1 If the actual noise level exceeds the maximum permitted noise level, it can usually be reduced by reducing bandwidth, but this will require beginning again at [5.3](#) to verify that the bandwidth reduction is permissible.

5.9 *Maximum Permissible Phase Difference and Maximum Permissible Data Skew*—These terms are discussed in [A1.5.1](#) and [A1.5.2](#). No value is recommended for the maximum permissible phase difference and data skew between channels, since this is very dependent on the testing application. If typical phase shifts between displacement and force due to the material under test are 10 to 20°, then an acceptable value for the maximum phase difference might be 1°. However, if typical phase shifts are 2 to 3°, the acceptable value for the maximum phase difference might be only 0.1°.

5.10 *Actual Phase Shift and Data Skew*—Methods for estimating the combined effect of phase shift and data skew in a data acquisition system are given in [A1.5.3](#).

6. Report

6.1 The purpose of the report is to record that due consideration was given to essential performance parameters of the data acquisition system when performing a particular fatigue or fracture mechanics test. Since the report should ideally be an attachment to each set of such test results, it should be sufficient but succinct. The report should contain the following information, preferably in a tabular format.

6.2 *Measurement Equipment Description*—This should include the manufacturer's name, model number, and serial number for the test hardware used.

6.3 *Waveshape and Highest Frequency Used During the Test*

6.4 *Minimum Bandwidth, Actual Bandwidth, and a Note About its Source*—The source is a note describing how actual bandwidth was ascertained, for example, from a manufacturer's data sheet or by a measurement.

6.5 *Minimum Data Rate, Actual Data Rate, and a Note About Source*—The source is a note describing how actual data

rate was ascertained, for example, from a manufacturer’s datasheet or by a measurement.

6.6 *Maximum Permissible Noise Level, Actual Noise Level, and a Note About Source*—The source is a note describing how actual noise level was ascertained, for example, from a manufacturer’s datasheet or by a measurement.

6.7 *(Where Applicable) Maximum Permissible Phase Difference, Actual Phase Difference, and a Note About Source.*

6.8 *(Where Applicable) Maximum Permissible Data Skew, Actual Data Skew, and a Note About Source.*

7. Keywords

7.1 bandwidth; data acquisition; data rate; data skew; drift; fatigue; filter; fracture mechanics; noise; phase shift; quantization; sample rate; signal conditioning; step response

ANNEX

(Mandatory Information)

A1. SOURCES AND ESTIMATION OF ERRORS

A1.1 Method of Establishing Error Limits

A1.1.1 The approach used to develop the required performance levels for Section 5 has been to arrive at a value for bandwidth, data rate, and so forth, at which there is a high probability the error due to each cause will not exceed 0.2 %, and in most cases will be much less than this. The following sections provide explanations of how these values were derived. The explanations may be used to assess how rapidly errors might be expected to increase when the conditions set up in Section 5 cannot be met. A heuristic approach is necessary because there are very many variations of data acquisition systems, each of which would require a complex analysis to establish its actual errors. The approach taken here is conservative but should arrive at reasonably safe system requirements. Of necessity, the descriptions here are brief; more detailed discussion can be found in references.^{3,4,5}

A1.2 Bandwidth

A1.2.1 *Amplitude Errors in Sinusoidal Waveforms Due to Insufficient Bandwidth*—As shown in Fig. 1, the amplitude response of a filter with sinusoidal waveform inputs falls off at frequencies above the cutoff frequency and will cause increasing amplitude errors as frequency increases. The amplitude responses of typical Butterworth filters are shown in Fig. A1.1(a); the amplitude response rolls off above the cut-off frequency at a rate which depends on the number of pole-pairs in the filter. Thus if a sinusoidal waveform were applied to this filter, for example for a force transducer, its amplitude would be increasingly in error at frequencies approaching and above the cut-off frequency. Fig. A1.1(b) shows how these computed errors will increase with frequency. Bessel filters are also common in mechanical testing instrumentation, and the comparable curves are shown in Fig. A1.2. By considering both Fig. A1.1(b) and Fig. A1.2(b), it can be concluded that when

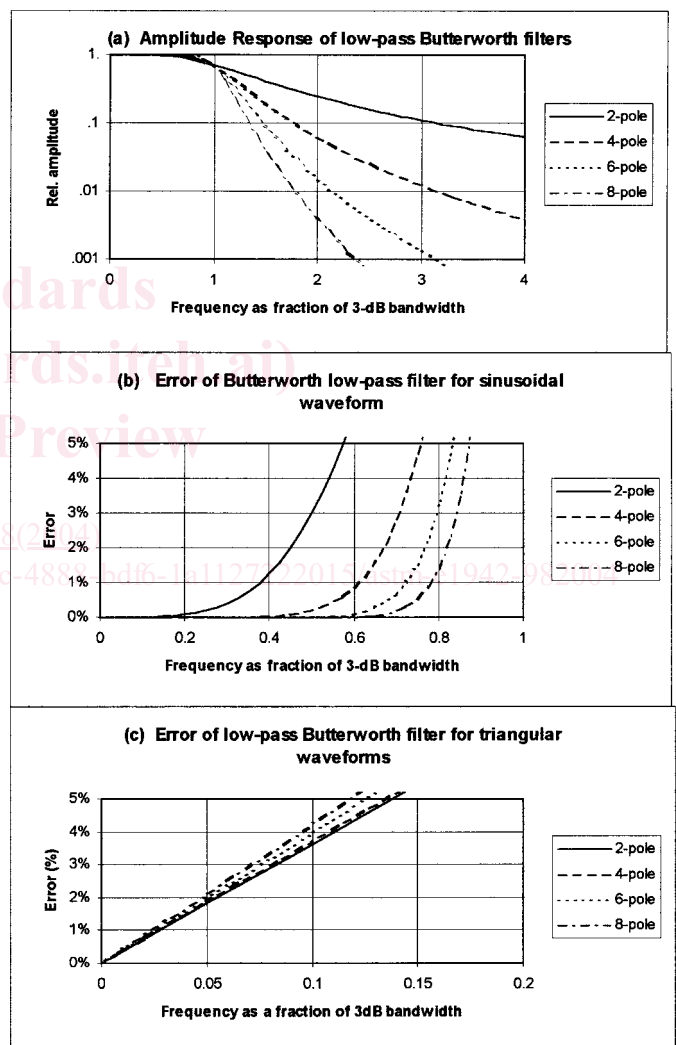

FIG. A1.1 Butterworth Filters

the actual filter type employed by the test system is not actually known, then a conservative assumption would be that it is necessary that the frequency being measured is not larger than about 0.1 of the filter bandwidth for sinusoidal waveforms.

A1.2.1.1 If the filter type is indeed known from vendor-supplied data, choose the characteristic in Fig. A1.1(a) or Fig.

³ Stein, P. K., *The Unified Approach to the Engineering of Measurement Systems for Test and Evaluation - I - Basic Concepts*, Stein Engineering Services Inc., 6th ed., Phoenix, AZ, 1995.

⁴ Tovey, F. M., “Measurement Uncertainty Analysis of a Transfer Standard Force Calibration System,” *Journal of Testing and Evaluation*, Vol. 22, No. 1, January 1994, pp. 70–80.

⁵ Wright, C. P., *Applied Measurement Engineering: How to Design Effective Mechanical Measurement Systems*, Prentice Hall, Englewood Cliffs, NJ, 1995.

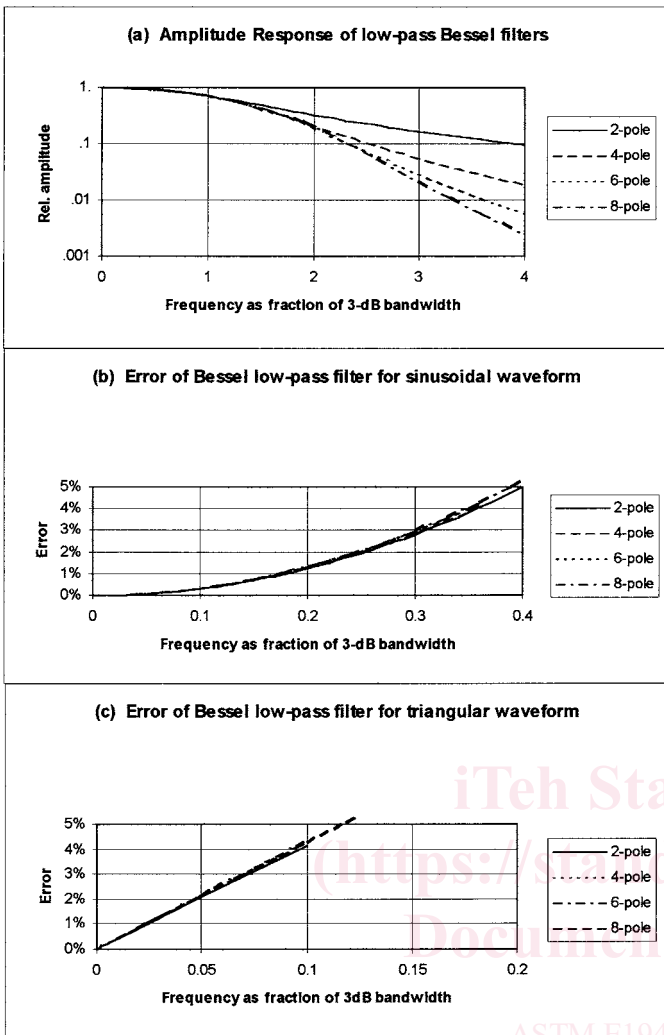

FIG. A1.2 Bessel Filters

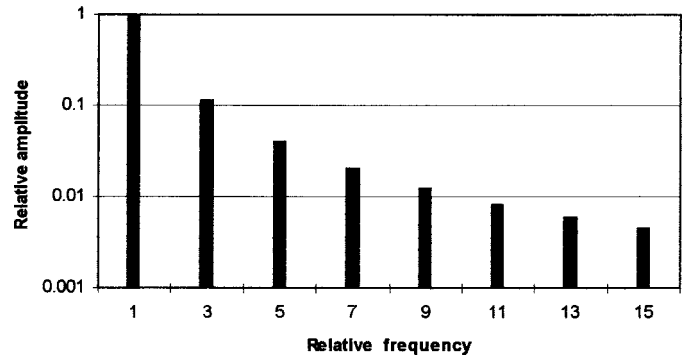

FIG. A1.3 Line Spectrum of a Triangular Waveform

A1.2.2.1 If the analog part of the signal conditioning were perfect, then this signal would be presented to the ADC to be sampled and digitized. In practice, however, the bandwidth of the analog channel is restricted, both to reduce noise and (in the case of conditioning systems with AC excitation) to remove the effects of demodulation. If we consider only the frequencies $i \cdot f$ of the signal, at each of these frequencies the filter will multiply the signal amplitude by b_i and add additional phase shift θ_i . At frequencies below the filter cutoff frequency, also called the bandwidth, $b_i \approx 1$ and $\theta_i \approx 0$. Above the cut-off frequency, b_i reduces towards zero and θ_i increases. If the signal has no significant amplitude in the harmonics a_i above the cutoff frequency, the filter will have no discernible effect on the signal. But, if indeed, there are harmonic components of significant amplitude above the filter cut-off frequency, then the signal will be distorted by the filter.

A1.2.2.2 A computation of these errors for Butterworth filters is shown in Fig. A1.1(c), and it can be seen that for errors below 0.5 %, the frequency would have to be less than 0.013 of the filter bandwidth. A similar conclusion can be reached for Bessel filters, as shown in Fig. A1.2(c). In practice, this will be very conservative, because the mechanical system will usually not be capable of generating a perfectly triangular waveform.

A1.2.2.3 For all other non-sinusoidal waveforms, the preceding limit for triangular waveforms will be a conservative estimate for the bandwidth needed, since a triangular waveform is the worst case likely to be encountered.

A1.2.3 Procedure: How to Estimate Actual Bandwidth:

A1.2.3.1 To estimate the actual bandwidth of a signal processing scheme, a measurement can be made of the step response of the system. This is the response of the measurement system to a step change in the input; the narrower the bandwidth, the slower the step response. Fig. A1.4 illustrates the response of a system to a step change in the parameter being measured by the transducer, and how this appears when digitized. The step responses of the different filters previously discussed are shown in Fig. A1.5, for a nominal bandwidth of 1 Hz. When the cut-off frequencies are raised, the time axes decrease proportionately. For example, if the bandwidth were 10 Hz, the time axis of the graph would span 0.4 s instead of 4 s.

A1.2.3.2 It can be shown that the bandwidth of any of these filters is simply related to the rise time between the 10 % and 90 % values of the step response, assuming the final amplitude is taken as 100 %. As can be seen from the table in Fig. A1.5,

A1.2(a) which is closest to the known filter characteristic, then use Fig. A1.1(b) or Fig. A1.2(b) to find the highest frequency which may be used within the permissible maximum error limit.

A1.2.2 Amplitude Errors in Non-Sinusoidal Waveforms Due to Insufficient Bandwidth—Errors in non-sinusoidal waveforms, such as triangular waveforms, can be more severe, because the amplitude of the harmonics begin to be affected when the fundamental frequency is still well below the cutoff frequency, and they are also affected by increasing phase shift. In the case of non-sinusoidal cyclic waveforms, these signals can be represented by a fundamental frequency and a number of multiples, or harmonics, of that frequency. These produce a line spectrum, as illustrated in Fig. A1.3 for a triangular waveform. The signal $x(t)$ can be represented exactly by a sum of sinusoids at the fundamental frequency f and its multiples, that is, $x(t) = \sum_{i=0}^{\infty} a_i * \cos(2\pi \cdot i \cdot f + \phi_i)$, where a_i is the amplitude of each harmonic and ϕ_i is the corresponding phase angle. As the order of the harmonic i increases, the amplitude generally decreases, and so only a small number of the harmonics have significance to $x(t)$. In Fig. A1.3, the third harmonic is 10 % of the amplitude of the fundamental, and the ninth harmonic is 1 % of the fundamental.

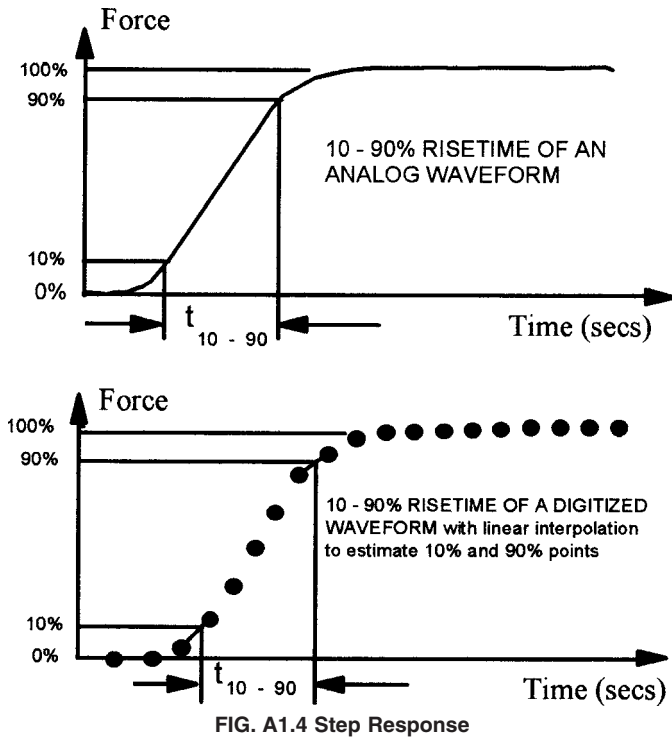

FIG. A1.4 Step Response

the rise time varies from 0.342 to 0.459 s for a 1-Hz bandwidth. Since Butterworth filters with large numbers of poles are less common (because of the increased ringing in the step response), it is common to use the following expression to estimate the bandwidth from the rise time.

$$\text{Bandwidth} = \frac{0.35}{t_{10-90}} \text{ Hz} \quad (\text{A1.1})$$

A1.2.3.3 To acquire the step response, it is necessary both to (1) create the step change in signal, and (2) have a method to record this.

A1.2.4 *Creating a Step Change Using a Shunt Calibration Facility*—The simplest measurement, which eliminates any mechanical problems, can be made if the system is provided with a shunt relay and resistor across the transducer to give a change in reading for verification purposes. This sudden change in transducer output is just as effective as breaking a specimen in producing a step input to the transducer conditioning, without the potential problem of mechanical ringing mentioned in A1.2.5. Before operating such a shunt relay, normal precautions, such as shutting off hydraulic power, should be taken to ensure the actuator does not move. Examples of data in this case are shown in Fig. A1.6.

A1.2.5 *Creating a Step Change By Breaking a Specimen*—If there is no shunt calibration relay available, then the next alternative is to produce a step change in force in the load string. One simple method to achieve this is to break a brittle specimen and record the sudden drop in load, for the fall-time is just as indicative of bandwidth as the rise time. For example, Fig. A1.7 shows the result of breaking a steel tape in a testing machine and capturing at a 5-kHz data rate the resulting sudden drop in force. In this machine, it was possible to vary the bandwidth to illustrate the changes in the step response, and three curves are shown, the first two showing

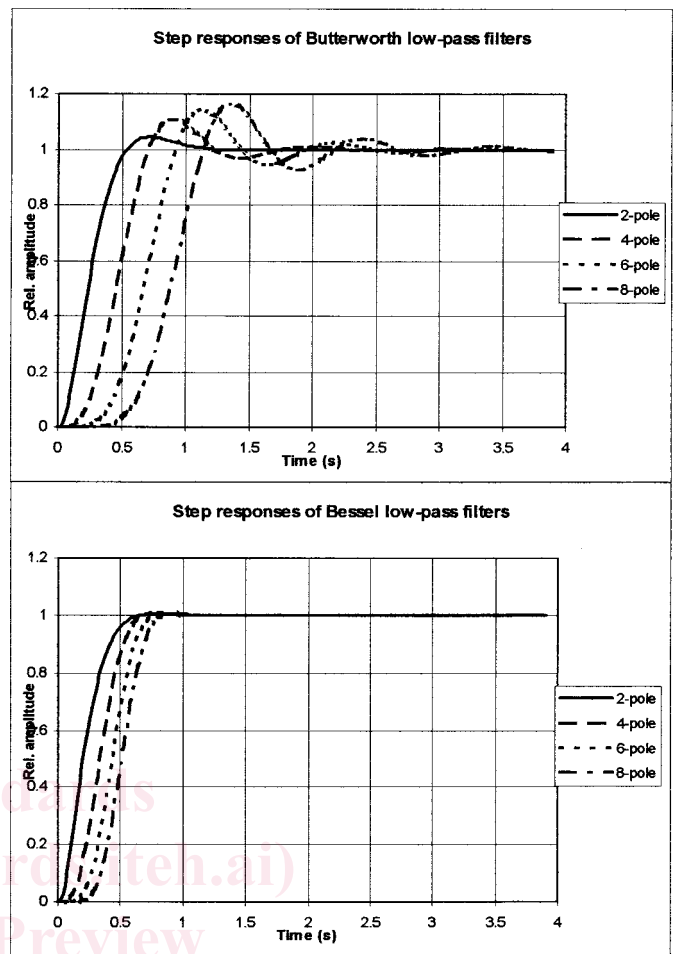

10-90% risetimes (secs) of step responses of 1Hz bandwidth filter

No. of poles	Butterworth	Bessel
2	0.342	0.342
4	0.387	0.349
6	0.426	0.349
8	0.459	0.346

FIG. A1.5 Computed Step Responses

data over 0.01 s, the last over 0.1 s. At 1-kHz bandwidth only about 2 data points cover the fall time of the step, but at lower bandwidths the resolution improves and more accurate estimates can be made. A problem at higher bandwidths that can be seen in this example is that the response is contaminated by ringing in the load string when the specimen breaks.

A1.2.6 *Recording the Step Response*—If the system produces an analog output, an analog recording device, such as an analog or a digital storage oscilloscope, may be used, and the step rise time may be measured on the oscilloscope screen or by down-loading the recorded response to a chart recorder. If the system is digital, it will be necessary to capture the response at a high enough data rate to ensure that several data samples are obtained during the rise time, as illustrated in the preceding examples. If there is an abrupt step and no data samples are obtained during the rise time, then all that can be concluded is that t_{10-90} must be equal to or less than the interval between data samples. Thus, using the time interval between samples will give a conservative minimum estimate of the bandwidth.