



Designation: F1157 – 04

Standard Practice for Classifying the Relative Performance of the Physical Properties of Security Seals¹

This standard is issued under the fixed designation F1157; the number immediately following the designation indicates the year of original adoption or, in the case of revision, the year of last revision. A number in parentheses indicates the year of last reapproval. A superscript epsilon (ϵ) indicates an editorial change since the last revision or reapproval.

1. Scope

1.1 This practice covers methods for testing the physical properties of mechanical (passive) security seals. Where appropriate, the various tests include particular apparatus or procedural specifications required for different types of security seals. This practice does not address adhesive (tape or label style) or electronic types of security seals.

1.2 This practice will serve as a basis for comparing the response of various security seals under different simulated modes of attack. The security seal to be evaluated shall first be classified into established groupings, and then tested in the manner designated as most suitable for that class of seal, in accordance with Classification F832.

1.3 A mechanical security seal is a single use, passive device intended to detect tampering or entry into the sealed item. Removal of the security seal requires permanent and irreversible damage to the seal. The following procedures reflect the relative performance of security seals when subject to various destructive physical attacks. These tests simulate known and likely security seal implementation and attack methods.

1.4 Security seals often contain unique identification markings for authentication purposes to discourage duplication and to prevent reapplication. This practice does not address unique identifiers or vulnerabilities of security seals.

NOTE 1—See Guide F1158 for procedures on the inspection and evaluation of tampering of security seals.

1.5 It is the responsibility of users of this practice to interpret their specific security needs concerning the application of seals, and to determine the grade of seal appropriate for their particular application. ASTM assumes no responsibility for losses occurring as a result of a defeated seal, whether the defeat is apparent, or the seal is not suited for its application.

1.6 The values as stated in inch-pound units are to be regarded as the standard. The values in parentheses are given for information only.

¹ This practice is under the jurisdiction of ASTM Committee F12 on Security Systems and Equipment and is the direct responsibility of Subcommittee F12.50 on Locking Devices.

Current edition approved Sept. 1, 2004. Published September 2004. Originally approved in 1988. Last previous edition approved in 2001 as F1157 – 90 (2001). DOI: 10.1520/F1157-04.

1.7 The following safety hazards caveat pertains only to the test procedures portion, Section 6, of this practice. *This standard does not purport to address all of the safety concerns, if any, associated with its use. It is the responsibility of the user of this standard to establish appropriate safety and health practices and determine the applicability of regulatory limitations prior to use.*

2. Referenced Documents

2.1 *ASTM Standards*:²

F832 Classification for Security Seals

F883 Performance Specification for Padlocks

F946 Guide for Establishing Security Seal Control and Accountability Procedures

F1158 Guide for Inspection and Evaluation of Tampering of Security Seals

3. Terminology

3.1 *Definitions*:

3.1.1 *locked seal*—condition, as intended by the manufacturer, which secures the sealed item and cannot be reversed or opened without physical destruction of the security seal.

3.1.2 *open condition*—condition which could allow entry into the sealed item and, for the purposes of this practice, a failed security seal.

3.1.3 *security seal*—passive, one-time locking device used to indicate tampering or entry, and may be designed to offer limited resistance to forced entry. Security seals require inspection to determine a tampering or entry event.

4. Summary of Practice

4.1 A security seal shall be evaluated in accordance with its classification into one of five general groups and its performance in the following six tests: pull (tensile) shear, bending, impact, low temperature impact, and high temperature pull (tensile).

4.2 A security seal shall receive a grade designation based upon its measured performance in each of the required tests.

² For referenced ASTM standards, visit the ASTM website, www.astm.org, or contact ASTM Customer Service at service@astm.org. For *Annual Book of ASTM Standards* volume information, refer to the standard's Document Summary page on the ASTM website.

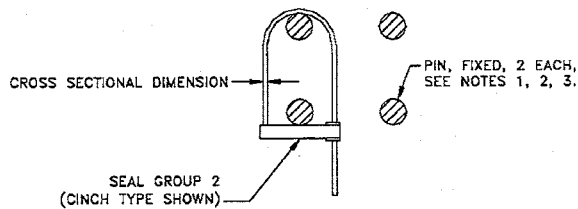
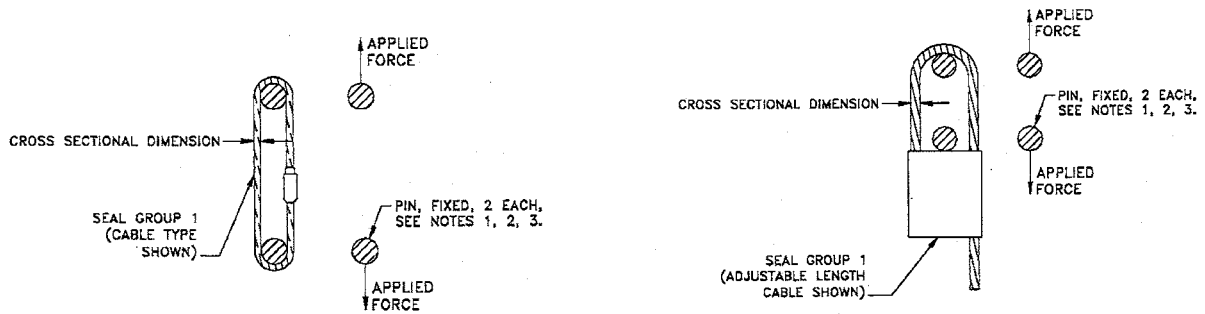

NOTE 1—Pin diameter 0.250 in. (6.35 mm) for smallest cross section dimension less than or equal to 0.125 in. (3.18 mm).
 NOTE 2—Pin diameter 0.500 in. (12.7 mm) for smallest cross section dimension greater than 0.125 in. (3.18 mm).
 NOTE 3—Tolerance: ± 0.010 in. (0.254 mm).

FIG. 1 Schematic Drawings of Pull (Tensile) Test Fixture Requirements for Groups 1 and 2

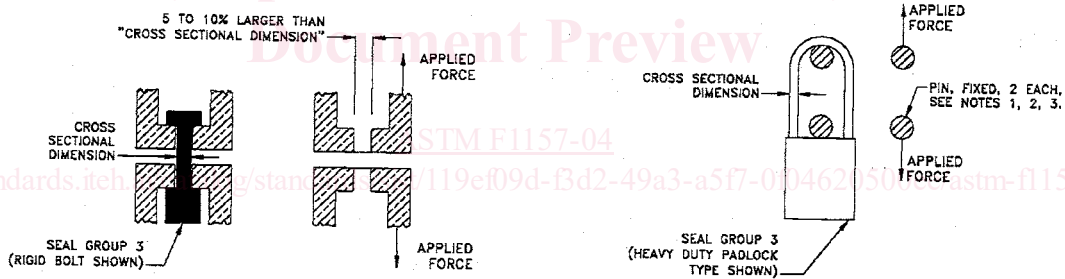

FIG. 2 Schematic Drawings of Pull (Tensile) Test Fixture Requirements for Group 3

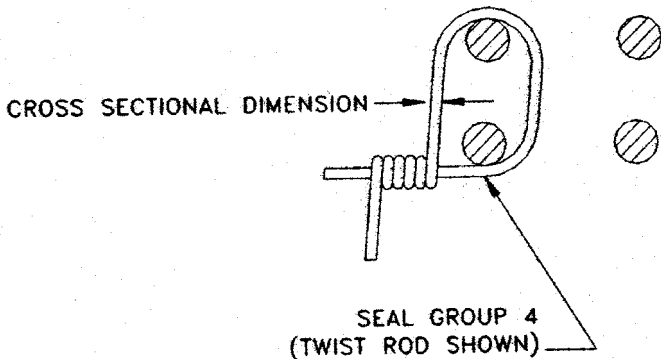

FIG. 3 Schematic Drawings of Pull (Tensile) Test Fixture Requirements for Group 4

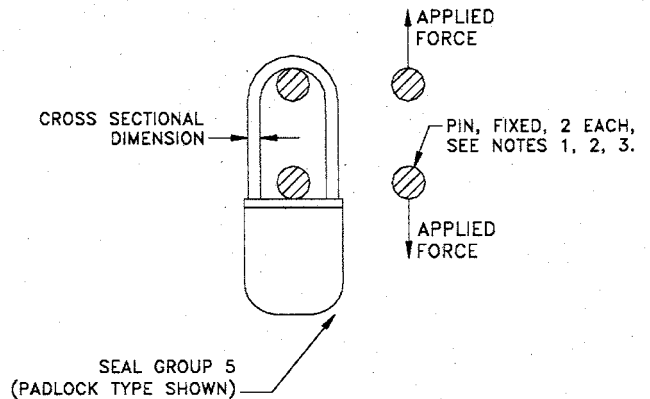

FIG. 4 Schematic Drawings of Pull (Tensile) Test Fixture Requirements for Group 5

This grade shall be obtained by testing five individual seals in each of the six specific tests. A minimum of 30 security seal

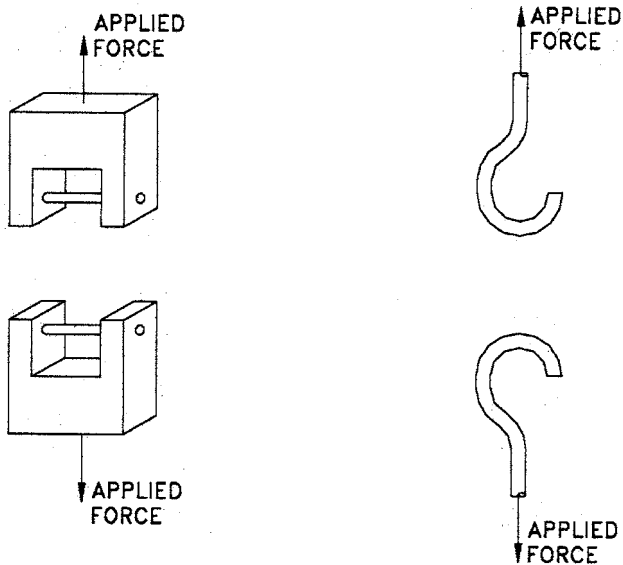
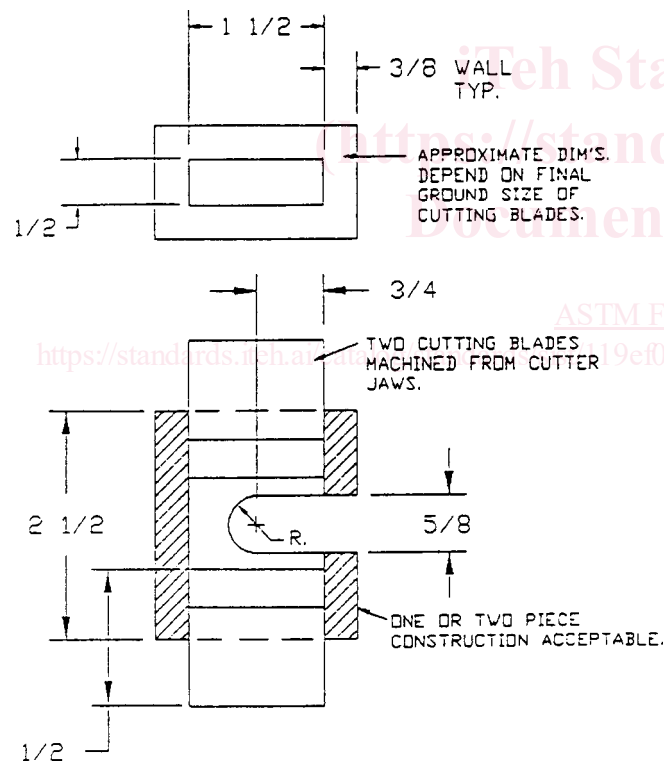

FIG. 5 Schematic Drawings of Possible Pull (Tensile) Test Fixture Configurations



NOTE 1—All dimensions are in inches (1 in. = 25.4 mm).
 NOTE 2—See Performance Specification F883 for definition of cutter jaws.

FIG. 6 Fixture for Use in Shear Test for Security Seals (Patterned After Padlock Shackle Cutting Fixture in Performance Specification F883)

specimens shall be required to complete testing. The grade designation shall be determined by comparing the average

value of the five test results to the corresponding grade classification tables presented in this practice.

4.3 All tests shall be performed at ambient room temperature $65 \pm 5^\circ\text{F}$ ($18.3 \pm 2.8^\circ\text{C}$) unless otherwise indicated.

5. Seal Classification

5.1 *General*—For the purpose of defining the most appropriate test configuration of the security seal during tests, the security seal shall be classified as an initial step in accordance with the groups defined in Classification F832.

5.2 For the purpose of comparing the physical properties of security seals, seals are grouped in accordance with the following description of application seals:

5.2.1 Groups:

5.2.1.1 *Group 1*—Flexible cable and wire seals, which can be fixed or adjustable length.

5.2.1.2 *Group 2*—Strap and cinch seals.

5.2.1.3 *Group 3*—Rigid bolt and rod seals, including heavy duty metal padlock type.

5.2.1.4 *Group 4*—Twisted rod or wire seals (pigtail).

5.2.1.5 *Group 5*—Padlock type seals, scored seals, metal or plastic base.

5.3 If a particular security seal does not appear to fall into any of these general classifications, the closest description shall be chosen by the user. The effectiveness of the testing procedures and relevance of the test data may be jeopardized by a faulty classification choice. These general groupings shall be assigned the arbitrary numerical listing of one through five, respectively, as shown in 5.2.1. The group number shall be documented with the test results.

5.4 The required performance levels in any test category shall not be affected by this general classification (see 5.2.1); only the manner in which the seal is physically manipulated during subsequent testing shall be affected by this portion of the evaluation. All seals shall be tested in a locked position using test fixtures appropriate for the seal group.

6. Test Procedures

6.1 Pull (Tensile) Test:

6.1.1 Apply a pull (tensile) load to the locked security seal in a direction opposite to the motion required to lock the seal. The travel rate of the test shall be 2 ± 1 in./min (5.08 ± 2.54 cm/min).

6.1.2 Fixtures necessary to perform this test are determined by the group classification of the security seal. Figs. 1-4 show fixture requirements for the classification groups. Possible fixture configurations are shown in Fig. 5.

6.1.2.1 Fixtures shall be designed such that applied stresses are within the elastic limit of the fixture material.

6.1.2.2 Fixtures shall be designed to eliminate any artificial influences upon the tested strength characteristics of the test specimen.

6.1.3 Record the tensile value required to cause an open condition for each of the five test specimens. Assign the grade designation in accordance with 4.2 and Table 1.

6.2 Shear Test:

6.2.1 Apply a shear force to the security seal specimen to measure its resistance to a severing action. The shear plane