



SLOVENSKI STANDARD
SIST EN 13232-9:2006+A1:2012
01-januar-2012

Železniške naprave - Zgornji ustroj - Kretnice in križišča - 9. del: Kretniški sklopi

Railway applications - Track - Switches and crossings - Part 9: Layouts

Bahnanwendungen - Oberbau - Weichen und Kreuzungen - Teil 9: Weichenanlagen

Applications ferroviaires - Voie - Appareils de voie - Partie 9: Ensemble de l'appareil

Ta slovenski standard je istoveten z: EN 13232-9:2006+A1:2011

[SIST EN 13232-9:2006+A1:2012](https://standards.iteh.ai/catalog/standards/sist/74e95371-11ea-4122-b2ed-191cb27487c5/sist-en-13232-9-2006a1-2012)

<https://standards.iteh.ai/catalog/standards/sist/74e95371-11ea-4122-b2ed-191cb27487c5/sist-en-13232-9-2006a1-2012>

ICS:

45.080	Tračnice in železniški deli	Rails and railway components
--------	-----------------------------	------------------------------

SIST EN 13232-9:2006+A1:2012 **en,fr,de**

iTeh STANDARD PREVIEW
(standards.iteh.ai)

[SIST EN 13232-9:2006+A1:2012](https://standards.iteh.ai/catalog/standards/sist/74e95371-11ea-4122-b2ed-191cb27487c5/sist-en-13232-9-2006a1-2012)

<https://standards.iteh.ai/catalog/standards/sist/74e95371-11ea-4122-b2ed-191cb27487c5/sist-en-13232-9-2006a1-2012>

EUROPEAN STANDARD
NORME EUROPÉENNE
EUROPÄISCHE NORM

EN 13232-9:2006+A1

October 2011

ICS 93.100

Supersedes EN 13232-9:2006

English Version

Railway applications - Track - Switches and crossings - Part 9: Layouts

Applications ferroviaires - Voie - Appareils de voie - Partie
9: Ensemble de l'appareil

Bahnwendungen - Oberbau - Weichen und Kreuzungen -
Teil 9: Weichenanlagen

This European Standard was approved by CEN on 13 February 2006 and includes Amendment 1 approved by CEN on 13 September 2011.

CEN members are bound to comply with the CEN/CENELEC Internal Regulations which stipulate the conditions for giving this European Standard the status of a national standard without any alteration. Up-to-date lists and bibliographical references concerning such national standards may be obtained on application to the CEN-CENELEC Management Centre or to any CEN member.

This European Standard exists in three official versions (English, French, German). A version in any other language made by translation under the responsibility of a CEN member into its own language and notified to the CEN-CENELEC Management Centre has the same status as the official versions.

CEN members are the national standards bodies of Austria, Belgium, Bulgaria, Croatia, Cyprus, Czech Republic, Denmark, Estonia, Finland, France, Germany, Greece, Hungary, Iceland, Ireland, Italy, Latvia, Lithuania, Luxembourg, Malta, Netherlands, Norway, Poland, Portugal, Romania, Slovakia, Slovenia, Spain, Sweden, Switzerland and United Kingdom.

[SIST EN 13232-9:2006+A1:2012](https://standards.iteh.ai/catalog/standards/sist/74e95371-11ea-4122-b2ed-191cb27487c5/sist-en-13232-9-2006a1-2012)

<https://standards.iteh.ai/catalog/standards/sist/74e95371-11ea-4122-b2ed-191cb27487c5/sist-en-13232-9-2006a1-2012>





EUROPEAN COMMITTEE FOR STANDARDIZATION
COMITÉ EUROPÉEN DE NORMALISATION
EUROPÄISCHES KOMITEE FÜR NORMUNG

Management Centre: Avenue Marnix 17, B-1000 Brussels

Contents

Page

Foreword.....	4
1 Scope	6
2 Normative references	6
3 Terms and definitions.....	7
4 General design process	11
4.1 General process.....	11
4.2 Design step details	12
4.3 Practical use of the design process	12
5 General design (design step 1)	14
5.1 Track layout.....	14
5.2 Geometrical design.....	14
5.2.1 Inputs	14
5.2.2 Rules	14
5.2.3 Geometry plan.....	14
5.3 Wheel rail interaction.....	15
5.3.1 Inputs	15
5.3.2 Rules	15
5.3.3 Output	23
6 Main constructional design (step 2)	43
6.1 Inputs	43
6.2 Structural requirements.....	44
6.2.1 General.....	44
6.2.2 General requirements.....	44
6.2.3 Specific requirements	44
6.2.4 Other requirements.....	46
6.3 Actuation, locking and detection design.....	47
6.4 Output – main construction documents.....	47
6.4.1 Geometry	47
6.4.2 Guidance.....	47
6.4.3 Actuation	47
6.4.4 Constructional.....	48
6.4.5 Information lists	48
7 Detailed component design (step 3)	48
7.1 Switches	48
7.2 Crossings	48
7.3 Expansion devices.....	48
7.4 Other components	49
7.5 Output – assembly documents	49
7.5.1 Main assembly documents	49
7.5.2 Optional documents	51
8 Acceptance (step 4).....	51
8.1 Inputs	51
8.1.1 Documents and plans.....	51
8.1.2 Limits of supply	51
8.2 Acceptance testing	51
8.2.1 Components acceptance	51
8.2.2 Layout assembly acceptance	52
8.3 Outputs	56
8.3.1 Documents	56
8.3.2 Traceability	56

8.3.3	Markings	56
Annex A	(informative) Design criteria	57
A.1	Geometry design	57
A.2	Wheel rail interaction	59
A.3	Actuation, locking and detection conformity	61
A.4	Switch design.....	63
A.5	Crossing design (with fixed parts).....	65
A.6	Crossing design (with moveable parts)	67
A.7	Expansion devices	69
Annex B	(informative) Layout acceptance form.....	70
B.1	Justification.....	70
B.2	Example of layout acceptance form	71
Annex C	(informative) Functional and safety dimensions, practically used by different European Networks.....	73
Annex D	(normative) Maximum angle of attack in obtuse crossings.....	74
Annex ZA	(informative)  Relationship between this European Standard and the Essential Requirements of EU Directive 2008/57/EC 	76
Bibliography	79

iTeh STANDARD PREVIEW (standards.iteh.ai)

[SIST EN 13232-9:2006+A1:2012](https://standards.iteh.ai/catalog/standards/sist/74e95371-11ea-4122-b2ed-191cb27487c5/sist-en-13232-9-2006a1-2012)

<https://standards.iteh.ai/catalog/standards/sist/74e95371-11ea-4122-b2ed-191cb27487c5/sist-en-13232-9-2006a1-2012>

Foreword

This document (EN 13232-9:2006+A1:2011) has been prepared by Technical Committee CEN/TC 256 "Railway applications", the secretariat of which is held by DIN.

This European Standard shall be given the status of a national standard, either by publication of an identical text or by endorsement, at the latest by April 2012, and conflicting national standards shall be withdrawn at the latest by April 2012.

A1 This document has been prepared under a mandate given to CEN/CENELEC/ETSI by the European Commission and the European Free Trade Association, and supports essential requirements of EU Directive 2008/57/EC.

For relationship with EU Directive 2008/57/EC, see informative Annex ZA, which is an integral part of this document. **A1**

This document includes Amendment 1, approved by CEN on 2011-09-13.

This document supersedes EN 13232-9:2006.

The start and finish of text introduced or altered by amendment is indicated in the text by tags **A1** **A1**.

Attention is drawn to the possibility that some of the elements of this document may be the subject of patent rights. CEN [and/or CENELEC] shall not be held responsible for identifying any or all such patent rights.

This series of standards "Railway applications — Track — Switches and crossings" covers the design and quality of switches and crossings in flat bottom rails. The list of parts is as follows:

- *Part 1 : Definitions*
- *Part 2 : Requirements for geometric design*
- *Part 3 : Requirements for wheel/rail interaction*
- *Part 4 : Actuation, locking and detection*
- *Part 5 : Switches*
- *Part 6 : Fixed common and obtuse crossings*
- *Part 7 : Crossings with moveable parts*
- *Part 8 : Expansion devices*
- *Part 9 : Layouts*

Part 1 contains terminology used throughout all parts of the standard.

Parts 2 to 4 contain basic design guides and are applicable to all switch and crossing assemblies.

Parts 5 to 8 deal with particular types of equipment, including their tolerances. These use parts 1 to 4 as a basis.

Part 9 defines the functional and geometrical dimensions and tolerances for layout assembly.

The following terms are used within to define the parties involved in using the EN as the technical basis for a transaction:

CUSTOMER The operator or user of the equipment, or the purchaser of the equipment on the user's behalf.

SUPPLIER The body responsible for the use of the EN in response to the customer's requirements.

According to the CEN/CENELEC Internal Regulations, the national standards organizations of the following countries are bound to implement this European Standard: Austria, Belgium, Bulgaria, Croatia, Cyprus, Czech Republic, Denmark, Estonia, Finland, France, Germany, Greece, Hungary, Iceland, Ireland, Italy, Latvia, Lithuania, Luxembourg, Malta, Netherlands, Norway, Poland, Portugal, Romania, Slovakia, Slovenia, Spain, Sweden, Switzerland and United Kingdom.

iTeh STANDARD PREVIEW (standards.iteh.ai)

[SIST EN 13232-9:2006+A1:2012](https://standards.iteh.ai/catalog/standards/sist/74e95371-11ea-4122-b2ed-191cb27487c5/sist-en-13232-9-2006a1-2012)

<https://standards.iteh.ai/catalog/standards/sist/74e95371-11ea-4122-b2ed-191cb27487c5/sist-en-13232-9-2006a1-2012>

1 Scope

The scope of this part is:

- to describe the design process of switches and crossings, and the use of the other parts of this standard;
- to define the main criteria to be taken into account during the design of the layout, including the safety and functional dimensions as well as geometrical and material aspects;
- to define the main criteria to be verified during the design approval;
- to define the geometrical and non-geometrical acceptance criteria for inspection of layouts assembled both in the fabrication plant and at track site in case of layouts that are delivered non or partially assembled or in a “kit” form;
- to determine the limits of supply;
- to define the minimum requirements for traceability.

This European Standard applies only to layouts that are assembled in the manufacturing plant or that are assembled for the first time at trackside.

Other aspects such as installation and maintenance also influence performance; these are not considered as part of this European Standard.

iTeh STANDARD PREVIEW
(standards.iteh.ai)

2 Normative references

[SIST EN 13232-9:2006+A1:2012](https://standards.iteh.ai/catalog/standards/sist/74e95371-11ea-4122-b2ed-191cb27487c5/sist-en-13232-9-2006a1-2012)

<https://standards.iteh.ai/catalog/standards/sist/74e95371-11ea-4122-b2ed-191cb27487c5/sist-en-13232-9-2006a1-2012>

The following referenced documents are indispensable for the application of this European Standard. For dated references, only the edition cited applies. For undated references, the latest edition of the referenced document (including any amendments) applies.

EN 13145, *Railway applications — Track — Wood sleepers and bearers*

EN 13230-4, *Railway applications — Track — Concrete sleepers and bearers — Part 4: Prestressed bearers for switches and crossings*

EN 13232-2, *Railway applications — Track — Switches and crossings — Part 2: Requirements for geometric design*

EN 13232-3, *Railway applications — Track — Switches and crossings — Part 3: Requirements for wheel/rail interaction*

EN 13232-4, *Railway applications — Track — Switches and crossings — Part 4: Actuation, locking and detection*

EN 13232-5, *Railway applications — Track — Switches and crossings — Part 5: Switches*

EN 13232-6, *Railway applications — Track — Switches and crossings — Part 6: Fixed common and obtuse crossings*

EN 13232-7, *Railway applications — Track — Switches and crossings — Part 7: Crossings with moveable parts*

prEN 13232-8, *Railway applications — Track — Switches and crossings — Part 8: Expansion devices*

EN 13481 (all parts), *Railway applications — Track — Performance requirements for fastening systems*

EN 13674-1, *Railway applications — Track — Rail — Part 1: Vignole railway rails 46 kg/m and above*

EN 13674-2, *Railway applications — Track — Rail — Part 2: Switch and crossing rails used in conjunction with Vignole railway rails 46 kg/m and above*

EN 13674-3, *Railway applications — Track — Rail — Part 3: Check rails*

EN 13674-4, *Railway applications — Track — Rail — Part 4: Vignole railway rails from 27 kg/m to, but excluding 46 kg/m*

EN 13715, *Railway applications — Wheelsets and bogies — Wheels — Tread profile*

prEN 13803-2, *Railway applications — Track alignment design parameters — Track gauges 1 435 mm and wider — Part 2: Switches and crossings and comparable alignment design situations with abrupt changes of curvature*

prEN 14730 (all parts), *Railway applications — Track — Aluminothermic welding of rails*

UIC 505-1, *Railway transport stock — Rolling stock construction gauge*

UIC 505-4, *Effects of the application of the kinematic gauges defined in the 505 series of leaflets on the positioning of structures in relation to the tracks and of the tracks in relation to each other*

UIC 510-2, *Trailing stock — Conditions concerning the use of wheels of various diameters with running gear of different types*

iTeh STANDARD PREVIEW

3 Terms and definitions (standards.iteh.ai)

For the purposes of this European Standard, the following terms and definitions apply.

[SIST EN 13232-9:2006+A1:2012](https://standards.iteh.ai/catalog/standards/sist/74e95371-11ea-4122-b2ed-191cb27487c5/sist-en-13232-9-2006a1-2012)

3.1 <https://standards.iteh.ai/catalog/standards/sist/74e95371-11ea-4122-b2ed-191cb27487c5/sist-en-13232-9-2006a1-2012>

guiding force Y

lateral force, acting parallel to the running surface, between the wheel and the relevant track component (usually a rail)

3.2

wheel load Q

force, acting perpendicular to the running surface, between the wheel on one hand and the relevant track component (rail)

3.3

contact angle γ_A

angle of the contact plane, measured at the contact point A between the wheel and the track component. In the case of a two-point contact, the one nearest the wheel flange will be considered.

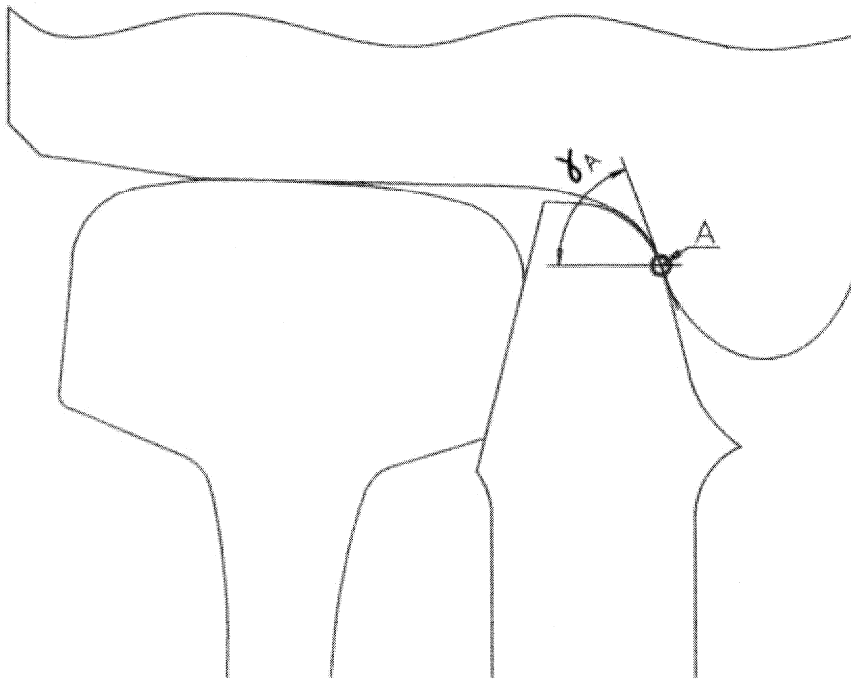

iTeh STANDARD PREVIEW (standards.iteh.ai)

Key

- γ_A contact angle
A contact point

SIST EN 13232-9:2006+A1:2012

<https://standards.iteh.ai/catalog/standards/sist/74e95371-11ea-4122-b2ed-191cb27487c5/sist-en-13232-9-2006a1-2012>

Figure 1 — Contact angle

This contact angle determines the contact danger zone on the wheel, as defined in EN 13232-3

3.4

friction coefficient μ

friction coefficient encountered at the contact point where the contact angle is determined

3.5

flange sharpness q_R

parameter which characterises the sharpness of the wheel flange. The measurement is taken in accordance with UIC 510-2 at the active side of the flange as defined in Figure 2. It is the distance, parallel to the wheel axis, between the following two points:

- reference point on the profile, at a distance from wheel axis of 10 mm more than the wheel radius;
- reference point located at a distance 2 mm from the flange tip towards the wheel axis

Dimensions in millimetres

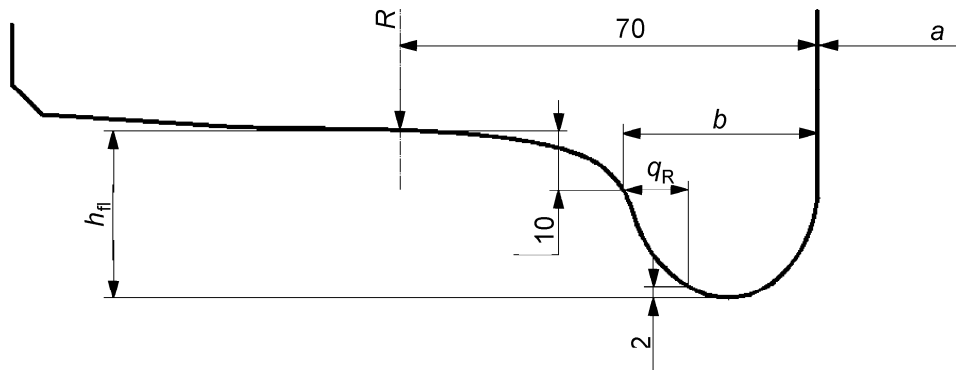
**Key**

a wheel back to back
 b flange width
 h_f flange depth

q_R flange sharpness
 R wheel radius

Figure 2 — Wheel parameters**3.6**

flange depth h_f
 see EN 13232-3

3.7

wheel back-to-back a

see EN 13232-2. The symbol " a " is used throughout this standard. An index max or min is given to this symbol according respectively to the maximum and minimum values that can occur during operation

3.8

flange width b

see EN 13232-2. The symbol " b " is used throughout this standard. An index max or min is given to this symbol according respectively to the maximum and minimum values that can occur during operation

3.9

switch point retraction E

distance, measured at the reference plane, between the reference line of switch and stock rail at the actual switch toe

iTeh STANDARD PREVIEW
 (standards.iteh.ai)

SIST EN 13232-9:2006+A1:2012

https://standards.iteh.ai/catalog/standards/sist/en-13232-9-2006/a1-2012/en-13232-9-2006-a1-2012

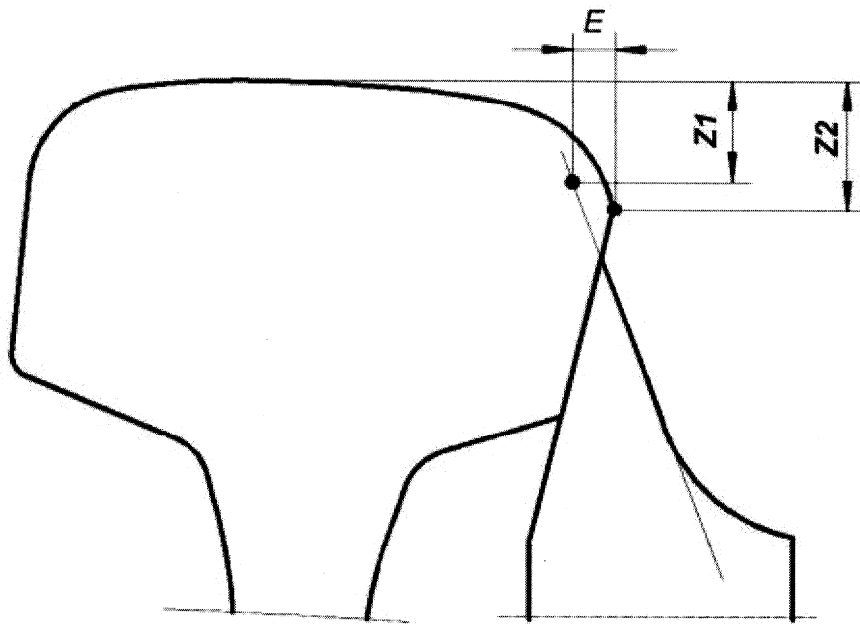
**Key**

E point retraction

Z1 switch rail machining reference plane (see EN 13232-5)

Z2 stock rail machining reference plane (see EN 13232-5)

iTeh STANDARD PREVIEW
(standards.iteh.ai)

Figure 3 — Switch point retraction

SIST EN 13232-9:2006+A1:2012

3.10**point retraction in fixed common crossing**

<https://standards.iteh.ai/catalog/standards/sist/74e95371-11ea-4122-b2ed-191cb27487c5/sist-en-13232-9-2006a1-2012>

reference line in a fixed common crossing which can deviate from the theoretical geometry line. From a certain distance to the crossing point, the reference line of the vee can, depending on the design, be removed from this theoretical line away from the wheel flange in order to avoid contact between both elements. This situation is described in Figure 4.

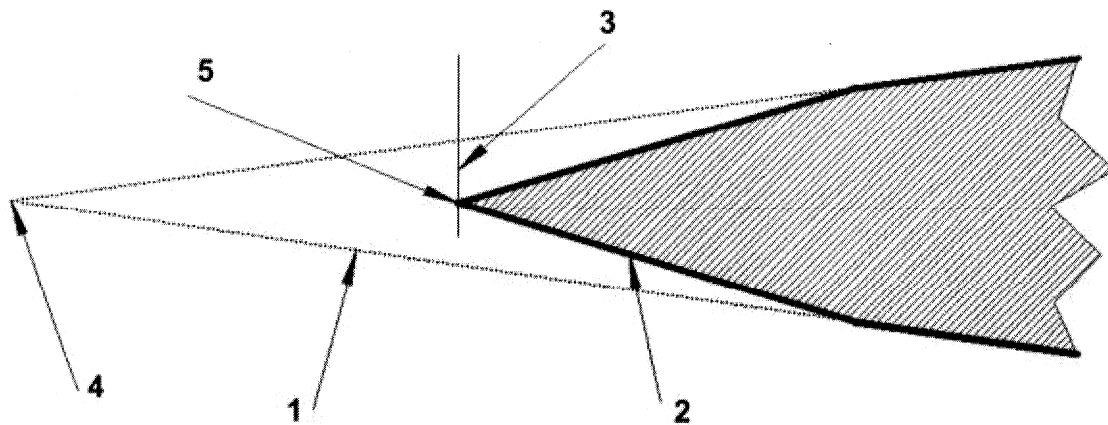

Key

- 1 theoretical reference line
- 2 actual reference line
- 3 point retraction
- 4 mathematical point (*MP*)
- 5 actual point (*RP*)

Figure 4 — Point retraction in fixed common crossing

The value of the point retraction is measured at the actual point (*RP*)

3.11

lead of turnout

distance between reference points of the different components of the S&C, e.g. the distance between theoretical points of crossing and switch in a standard layout. The lead is measured parallel to the reference line, except when stated otherwise

4 General design process

4.1 General process

The design process of switches and crossings is complex due to the many requirements that apply and the different situations that may occur. Figure 5 gives a schematic representation of the general design process. It separates the whole process into 4 main steps:

- step 1 contains the general design of the S&C. It permits the definition of the fundamental aspects of the S&C, respecting the main design requirements, as defined in parts 2 to 4;
- step 2 is the main constructional design process, which specifies the main construction of the S&C;
- step 3 consists of the detailed design of the individual components;
- step 4 is the product acceptance.

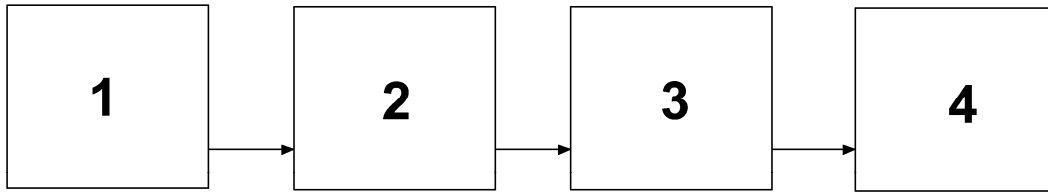

Key

- 1 step 1: General design
- 2 step 2: Main constructional design
- 3 step 3: Detailed component design
- 4 step 4: Acceptance

Figure 5 — General design process

Step 1 consists of the geometrical design, the design of the wheel-rail interaction and the design requirements for compliance with the actuation, locking and detection system.

Step 2 is based on the technology used by the supplier and is not dealt with in detail by any standard. It is mainly based on the suppliers' experience and expertise.

Step 3 is dealt with in different standards. The design of the main components shall respect the requirements laid down in parts 5 to 8. Other components, such as fastenings, bearers, etc, are dealt with in respective EN's.

4.2 Design step details

SIST EN 13232-9:2006+A1:2012

[https://standards.iteh.ai/catalog/standards/sist/74e95371-11ea-4122-b2ed-](https://standards.iteh.ai/catalog/standards/sist/74e95371-11ea-4122-b2ed-191b3742555a/en-13232-9-design-2006)

- a) Every design step requires sufficient **input data** to enable the design to be completed.
- b) These input data are dealt with by the supplier through the **design rules**. The rules are defined in EN 13232, parts 2 to 8.
- c) The result of the different design steps are **outputs**.

All these aspects are schematically represented for each design step in Figure 6, with a reference to the different parts and clauses where these aspects are dealt with in detail.

4.3 Practical use of the design process

The previous scheme deals with the complete design process of the S&C. The use of the standard is not limited to this case only.

The customer may choose to instruct the supplier to perform the whole design process and therefore the customer would provide all the necessary input data to permit the supplier to perform the design

The customer may also opt to instruct the supplier to perform only parts of the design process. In this case the customer shall deliver all inputs of the design steps he has requested the supplier to perform. This means that he has to deliver all outputs of the previous design steps.

EXAMPLE 1 The customer may instruct the supplier to perform the detailed design of an S&C layout based on the geometry of an existing design for use on a main railway line. In this case the customer shall provide the supplier with the outputs from geometrical requirements (the geometry plan) as well as the requirements for wheel-rail interaction, specified by the functional and safety dimensions.

Based on this information and the inputs for both conformity for actuation, locking and detection (ALD) and general requirements, he performs the general and detailed component design.

EXAMPLE 2 The customer may instruct the supplier to fabricate an S&C layout in accordance with an existing design. He therefore shall deliver all detailed plans to the supplier. The supplier only has to do step 4 of the general design process.

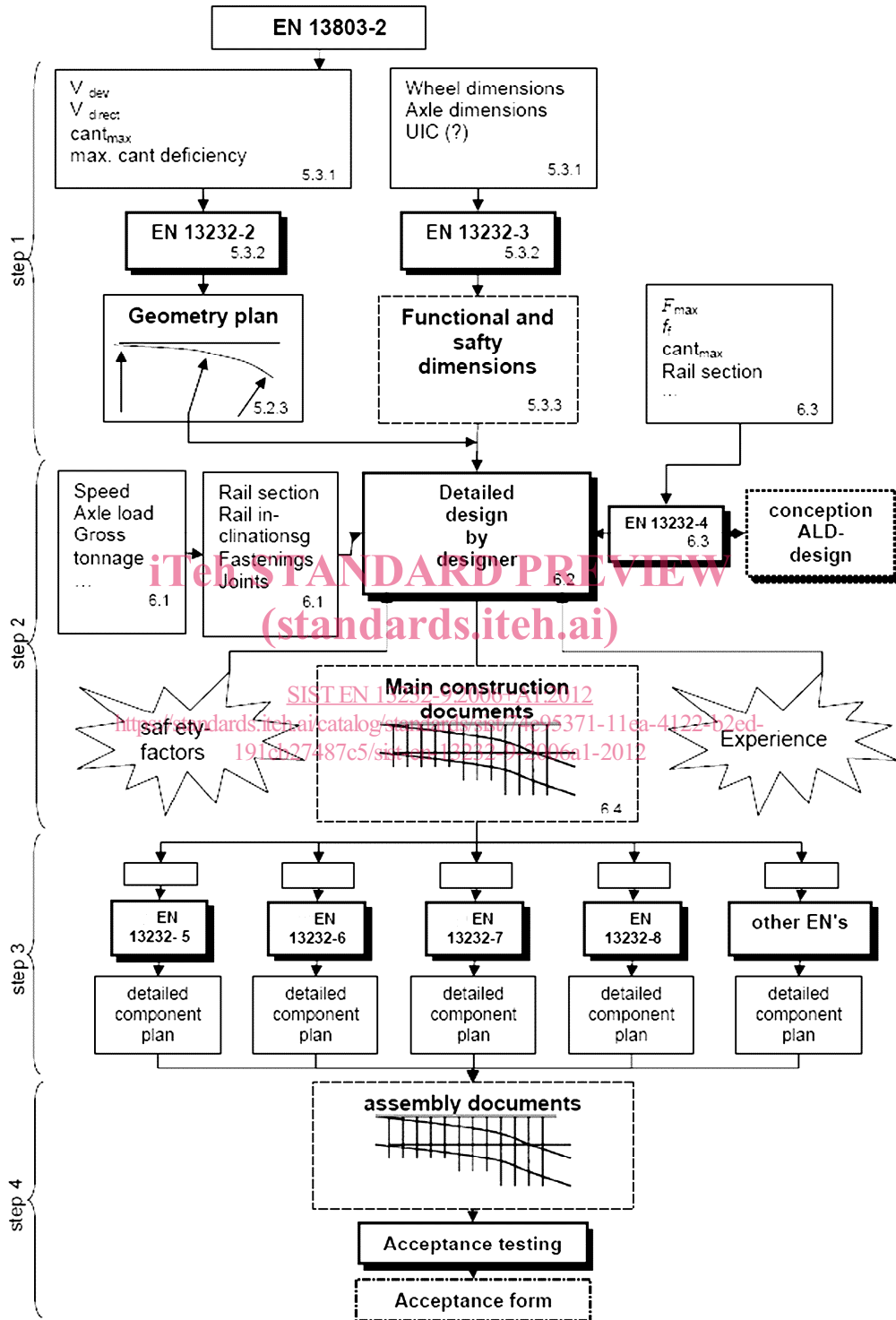

NOTE Subclause references in Figure 6 relate to this European Standard.

Figure 6 — Design process

