



SLOVENSKI STANDARD
SIST-TP CEN/TR 13387-3:2015
01-september-2015

Nadomešča:
SIST-TP CEN/TR 13387:2005

Izdelki za otroke - Smernice o splošni varnosti - Nevarnosti zaradi mehanskih lastnosti

Child use and care articles - General safety guidelines - Mechanical hazards

iTeh STANDARD PREVIEW
(standards.iteh.ai)

Ta slovenski standard je istoveten z: [SIST-TP CEN/TR 13387-3:2015](https://standards.iteh.ai/standards/SIST-TP-CEN-TR-13387-3-2015) CEN/TR 13387-3:2015
42881252aa68/sist-tp-cen-tr-13387-3-2015

ICS:

97.190 Otroška oprema Equipment for children

SIST-TP CEN/TR 13387-3:2015 **en,fr,de**

iTeh STANDARD PREVIEW
(standards.iteh.ai)

[SIST-TP CEN/TR 13387-3:2015](#)

<https://standards.iteh.ai/catalog/standards/sist/7d6fb998-7216-468a-b5c0-42881252aa68/sist-tp-cen-tr-13387-3-2015>

TECHNICAL REPORT
RAPPORT TECHNIQUE
TECHNISCHER BERICHT

CEN/TR 13387-3

July 2015

ICS 97.190

Supersedes CEN/TR 13387:2004

English Version

Child use and care articles - General safety guidelines - Mechanical hazards

This Technical Report was approved by CEN on 8 December 2014. It has been drawn up by the Technical Committee CEN/TC 252.

CEN members are the national standards bodies of Austria, Belgium, Bulgaria, Croatia, Cyprus, Czech Republic, Denmark, Estonia, Finland, Former Yugoslav Republic of Macedonia, France, Germany, Greece, Hungary, Iceland, Ireland, Italy, Latvia, Lithuania, Luxembourg, Malta, Netherlands, Norway, Poland, Portugal, Romania, Slovakia, Slovenia, Spain, Sweden, Switzerland, Turkey and United Kingdom.

iTeh STANDARD PREVIEW
(standards.iteh.ai)

[SIST-TP CEN/TR 13387-3:2015](https://standards.iteh.ai/catalog/standards/sist/7d6fb998-7216-468a-b5c0-42881252aa68/sist-tp-cen-tr-13387-3-2015)

<https://standards.iteh.ai/catalog/standards/sist/7d6fb998-7216-468a-b5c0-42881252aa68/sist-tp-cen-tr-13387-3-2015>



EUROPEAN COMMITTEE FOR STANDARDIZATION
COMITÉ EUROPÉEN DE NORMALISATION
EUROPÄISCHES KOMITEE FÜR NORMUNG

CEN-CENELEC Management Centre: Avenue Marnix 17, B-1000 Brussels

Contents

Page

European foreword	5
1 Scope	6
2 Mechanical hazards - Safety philosophy	6
3 Terms and definitions	6
4 Accessibility of mechanical hazards	6
4.1 General.....	6
4.2 Accessibility areas	7
4.3 Product information.....	8
5 Entrapment hazards	9
5.1 Introduction	9
5.2 Entrapment of head and neck	10
5.2.1 Rationale.....	10
5.2.2 Terms and definitions related to entrapment hazards.....	11
5.3 Requirements	12
5.4 Test equipment	12
5.4.1 Probe philosophy.....	12
5.4.2 Hip probe	12
5.4.3 Small head probe	13
5.4.4 Large head probe.....	14
5.4.5 Template for partially bound and V-shaped openings.....	15
5.4.6 Selection and use of probes.....	16
5.5 Test methodology	17
5.5.1 Feet first openings.....	17
5.5.2 Head first openings	17
5.5.3 Partially bound, V and irregular shaped openings.....	17
5.6 Entrapment of fingers	19
5.6.1 Rationale.....	19
5.6.2 Requirements	20
5.6.3 Test equipment	20
5.6.4 Test Methodology	21
5.7 Rationale for entrapment of limbs, feet and hands	21
6 Hazards from moving parts	22
6.1 Rationale.....	22
6.2 General.....	22
6.3 Shearing hazards	22
6.3.1 Requirements	22
6.3.2 Test equipment	23
6.3.3 Test method.....	23
6.4 Requirements for crushing hazards	23
7 Hazards with products designed to fold for storage and transportation.	23
7.1 Rationale.....	23
7.2 Terms and definitions related to hazards with products designed to fold.....	23
7.3 Requirements	24
7.3.1 General.....	24
7.3.2 Unintentional release of locking mechanisms	24
7.3.3 Test methodology	24

8	Hazards related to attachment mechanisms and opening and closing systems	24
8.1	Rationale.....	24
8.2	Requirement.....	25
8.3	Test methodology.....	25
9	Entanglement hazards	25
9.1	Snagging hazards.....	25
9.1.1	Rationale.....	25
9.1.2	Requirements.....	25
9.1.3	Test Equipment.....	25
9.1.4	Test Methodology for loop and mass.....	27
9.2	Cords, ribbons and parts used as ties	28
9.2.1	Rationale.....	28
9.2.2	Requirements.....	28
9.2.3	Test methodology.....	29
9.3	Loops	29
9.3.1	Rationale.....	29
9.3.2	Requirements.....	29
9.3.3	Test methodology.....	29
10	Choking hazards.....	30
10.1	Introduction.....	30
10.2	Hazard due to small components	30
10.2.1	Rationale.....	30
10.2.2	Requirements.....	30
10.2.3	Test equipment (also used in 11.2.3).....	31
10.2.4	Test methodology (also in 11.2.4).....	33
10.3	Accessibility of filling materials.....	34
10.3.1	Rationale.....	34
10.3.2	Requirement.....	34
10.3.3	Test equipment.....	34
10.3.4	Test methodology.....	35
10.4	Airway obstruction	36
10.4.1	Rationale.....	36
10.4.2	Protective mechanisms of the airway	38
10.4.3	Requirements.....	38
10.4.4	Test equipment	38
10.4.5	Test methodology.....	39
11	Suffocation hazards	39
11.1	Introduction.....	39
11.2	Plastic decals and sheeting	40
11.2.1	Rationale.....	40
11.2.2	Requirements.....	40
11.2.3	Determination of hazard	40
11.2.4	Test equipment	40
11.2.5	Test methodology.....	41
11.3	Non air-permeable packaging	41
11.3.1	Rationale.....	41
11.3.2	Requirements - Packaging	42
11.3.3	Test equipment	42
11.3.4	Test methodology.....	42
12	Ingestion hazards	42
12.1	Rationale.....	42
12.2	Ingestion of small components	43
12.2.1	Requirements.....	43
12.2.2	Test equipment (Also used in 11.2.3)	43
12.2.3	Test methodology.....	45

CEN/TR 13387-3:2015 (E)

13	Hazardous edges and projections	46
13.1	Introduction	46
13.2	Edges	46
13.2.1	Rationale	46
13.2.2	Requirements - Edges on products and components	46
13.2.3	Test methodology	47
13.3	Rigid protruding parts	47
13.3.1	Rationale	47
13.3.2	Requirements	47
13.3.3	Test methodology	47
13.4	Points and wires	47
13.4.1	Rationale	47
13.4.2	Requirement	47
14	Structural integrity	47
14.1	Introduction	47
14.2	Material suitability	48
14.2.1	Rationale	48
14.2.2	Requirements	48
14.3	Strength and durability of the product	49
14.3.1	Rationale	49
14.3.2	Requirements	49
14.3.3	Test methodology	49
15	Protective function	49
15.1	Introduction	49
15.2	Barrier function	49
15.2.1	Rationale	49
15.2.2	Requirements	50
15.2.3	Test equipment - Hip probe	50
15.2.4	Test methodology	51
15.3	Restraint systems	51
15.3.1	Rationale	51
15.3.2	Terms and definitions related to restraint systems	52
15.3.3	Requirements	52
15.3.4	Test equipment	52
15.3.5	Test methodology	53
15.4	Footholds	54
15.4.1	Rationale	54
15.4.2	Requirements	54
15.4.3	Test equipment (Templates)	55
15.4.4	Determination of a foothold	55
15.4.5	Test methodology	57
16	Hazard associated with stability	59
16.1	Rationale	59
16.2	General requirement	59
	Bibliography	60

iTeh STANDARD PREVIEW

(standards.iteh.ai)

SIST-TP CEN/TR 13387-3:2015

[https://standards.iteh.ai/catalog/standards/sist/7d61b998-7216-468a-b5c0-](https://standards.iteh.ai/catalog/standards/sist/7d61b998-7216-468a-b5c0-42881252aa68/sist-tp-cen-tr-13387-3-2015)[42881252aa68/sist-tp-cen-tr-13387-3-2015](https://standards.iteh.ai/catalog/standards/sist/7d61b998-7216-468a-b5c0-42881252aa68/sist-tp-cen-tr-13387-3-2015)

European foreword

This document (CEN/TR 13387-3:2015) has been prepared by Technical Committee CEN/TC 252 “Child use and care articles”, the secretariat of which is held by AFNOR.

Attention is drawn to the possibility that some of the elements of this document may be the subject of patent rights. CEN [and/or CENELEC] shall not be held responsible for identifying any or all such patent rights.

This document supersedes CEN/TR 13387:2004.

CEN/TR 13387 comprises the following five parts:

- Part 1: Safety philosophy and safety assessment
- Part 2: Chemical hazards
- Part 3: Mechanical hazards
- Part 4: Thermal hazards
- Part 5: Product information

CEN/TR 13387-3 should be used in conjunction with CEN/TR 13387-1.

This new edition of this Technical Report is a hazard based Technical Report. In comparison with the previous version, the main changes related to the section on Mechanical hazards are:

- Ageing and wear: Reworded; [SIST-TP CEN/TR 13387-3:2015](https://standards.iteh.ai/catalog/standards/sist/7d6fb998-7216-468a-b5c0-42881252-668/sist-tp-cen-tr-13387-3-2015)
- Accessibility of mechanical hazards: Reworded;
- Entrapment Hazards: Addition of a new finger probe and a hip probe;
- Hazards from moving parts: Moving parts separated into two main areas;
- Entanglement hazards: Improvement of the diagram for the ball and chain test; clarification of the clause for “Cords, ribbons and parts used as ties”;
- Suffocation hazards: Clarification of the clause for “Non air-permeable packaging”;
- Hazardous edges and projections: Drawings deleted;
- Protective function: Addition of a hip probe;
- Footholds: Reworded.

CEN/TR 13387-3:2015 (E)

1 Scope

This Technical Report provides guidance information on mechanical hazards that should be taken into consideration when developing safety standards for child use and care articles. In addition, these guidelines can assist those with a general professional interest in child safety.

2 Mechanical hazards - Safety philosophy

This clause addresses the most widely known mechanical hazards and is intended to provide guidance when drafting standards for child use and care articles.

Anthropometric data and information on the abilities of children related to risks are given in Annex A of CEN/TR 13387-1:2015. When using these data for setting requirements, adequate safety margins should be considered. These data refer to static and not dynamic anthropometric data, therefore care should be taken if using these data for anything other than static situations when drafting standards.

When drafting standards, conditions of use should be considered, bearing in mind the behaviour of children. Also, it is to be considered whether the child is attended or unattended when using the product and also the child's access to hazardous features.

For each mechanical hazard a rationale is given, explaining the potential hazard to the child. Requirements, test equipment and test methods are also given. Where appropriate, these can be used when drafting standards.

3 Terms and definitions

ITeH STANDARD PREVIEW
(standards.iteh.ai)

For the purposes of this document, the following terms and definitions related to mechanical hazards apply.

3.1 mechanical hazards [SIST-TP CEN/TR 13387-3:2015](https://standards.iteh.ai/catalog/standards/sist/7d6fb998-7216-468a-b5c0-12891534668a/sist-tp-cen-tr-13387-3-2015)
physical factors which may give rise to injury due to the mechanical properties of products/product parts

3.2 reach envelopes
age related physical data on the reach limits of the limbs of children in different postures, see 4.2

3.3 ageing
change of properties of the material due to exposure to environmental factors such as temperature, humidity, UV radiation, cleaning agents etc

3.4 mechanical wear
change of mechanical properties due to fatigue or repeated operation of devices, mechanisms and other parts of the product

4 Accessibility of mechanical hazards

4.1 General

Within the mechanical section no reference is made to specific areas of access, known as access zones. It would be wrong for this guidance document to specify exact areas of access as these should be determined in relation to the hazards and risks of individual products and risks when drafting the standard. As a general guidance to the types of contact associated with mechanical hazards, the following examples are given:

- the hazardous part is in reach of the child from the intended position of use in particular by head, mouth, hands or feet and there is a high probability for frequent, intensive and/or prolonged contact. Requirements need to address this primary contact;
- the hazardous part may be reached by the child or any other child beyond the intended position of use. The product is considered to remain in its intended position(s). Access to hazardous parts is gained by passing/moving around the product or when proceeding to the intended position. The risk of harm deriving from frequent, intensive and/or pro-longed contact may be less probable;
- the hazardous part exists, but cannot be reached by any child.

Irrespective of the access category, the reasonably foreseeable conditions of use should always be considered when designing children's products and/or writing product standards.

4.2 Accessibility areas

Information for determination of accessibility areas in connection with age group is given in Table 1 and Figure 1. These reach envelopes are based on a computer simulation, therefore the dimensions should be treated with care. If in the future experiments with children are undertaken, these figures in the table may be determined more accurately.

Table 1 — Reach envelopes for guidance in the specification of accessibility areas in standards - anthropometric data related to Figure 1

Dimension (mm) ›	Overhead Reach	Overhead Reach on tiptoes	Span	Overhead Reach Sitting	Arm Reach	Buttock-Foot	Lower Leg Length
Age group	L1	L1'	L2	L3	L4	R1	R2
0 to 6 months	760	660	660	550	250	300	150
6 to 12 months	880	960	770	610	290	380	190
12 to 36 months	1 160	1 260	1 020	770	420	550	275
36 to 48 months	1 270	1 370	1 070	810	460	630	315

All dimensions are based on P95 values. L1, L1', L2, L3, L4, have been assessed with the computer program ADAPS (© 79-93 TU-Delft University of Technology, Faculty of Industrial Design Engineering). R1 = buttock - foot length (Annex A, Table 3). R2 = 0,5 x R1.

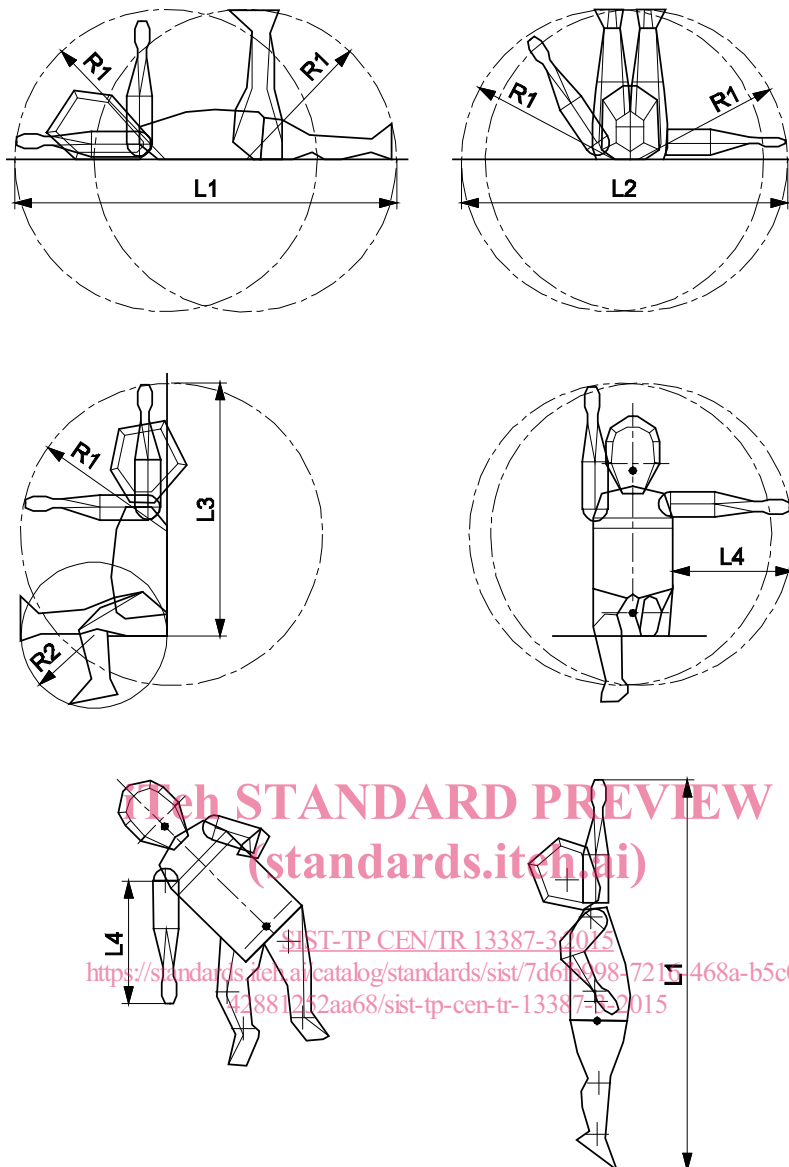

©79-93 TU-Delft University of Technology Faculty of Industrial Design Engineering

Figure 1 — Reach envelopes for determination of accessibility areas

4.3 Product information

In order to ensure mechanical safety, the information for the carer should include appropriate instructions and warnings. For example:

- the need for restraint system and its adjustment;
- the opening and closing of products;
- the operation of safety locks for foldable parts;
- the method of attachment to fixed structures or to other products.

Instructions should also inform the carer of the need to inspect the product regularly and also to use only replacement parts that are approved by the manufacturer/supplier.

CEN/TR 13387-5:2015 "Product information" gives detailed advice concerning the presentation of product information.

5 Entrapment hazards

5.1 Introduction

To avoid entrapment of head, neck, fingers, feet, and hands, safety distances are recommended in relation to the anthropometric data (see Annex A of CEN/TR 13387-1:2015) of the growing child. It is important to take into account the intended age and/or development level of the child. As a priority, those parts of a product which are accessible when a child is using the product as foreseeable should be considered. It may also be appropriate for gaps and openings beyond these accessible areas to be addressed. Gaps and openings which are inaccessible need not to be considered. However, V-shaped openings or V-shaped arrangements of structural members should be avoided.

Important entrapment hazards are:

- entrapment of the neck in situations where the child is incapable of raising its body weight to relieve the pressure (e.g.: crawling child on the outside of play pen, V shapes, etc.);
- entrapment of the neck in situations where the child slips through a gap feet first (e.g.: child slipping between bars/slats);
- entrapment of fingers, which may cause loss of blood supply to the tips.

If it is possible to position a child use and care article next to other furniture or a wall and create an entrapment hazard between them, an instruction should be included to warn carers of this possible entrapment hazard. When considering entrapment hazards dynamic situations should be considered as well as static hazards. The dynamic situation will increase the force being applied to a trapped torso or finger through the weight, movement or momentum of the child which will increase the risk of injury.

To assist with this an entrapment matrix has been included, see Figure 2, which was based on work done in ISO/IEC Guide 50. This entrapment matrix does not impart any hierarchy in the severity of the hazards shown and the specific hazard clause should be referred to.

CEN/TR 13387-3:2015 (E)

Body part	Completely bound openings		Partially bound openings	V shapes
	Rigid	Non-rigid		
Head neck, head first				
Finger				
Head neck, feet first		<p style="text-align: center;">STANDARD PREVIEW (standards.iteh.ai)</p> <p style="text-align: center;">http://standards.iteh.ai/catalog/standards/sist/7d6fb998-7216-468a-b5c0-42881252aa68/sist-tp-cen-tr-13387-3-2015</p>		

Figure 2 — Entrapment matrix

5.2 Entrapment of head and neck

5.2.1 Rationale

Head and neck hazards occur when the child is in a position where its body weight is supported by its neck and the child is incapable of lifting its body weight to relieve pressure on its neck. When this occurs it will cause airways to close and restrict the blood flow leading to brain damage.

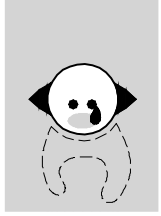
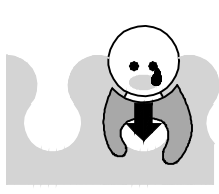
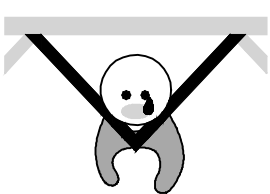
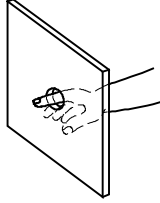
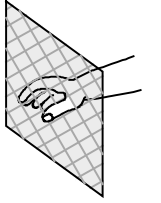
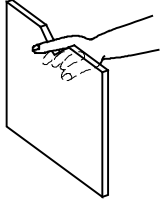
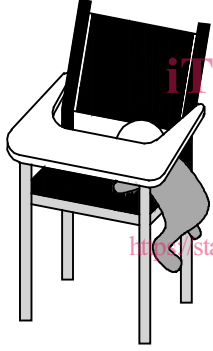
The risk of head and neck entrapment increases as the child's mobility and ability increases, enabling the child to access a wider range of hazards and products. The hazard is directly related to the size of the child's head and hip.

The hazard can be avoided by limiting the size and shape of completely bound, partially bound and 'V' shaped openings (see definitions in 5.2.2).

5.2.2 Terms and definitions related to entrapment hazards

5.2.2.1

completely bound opening

an opening that is continuously surrounded on all sides by the material of the product, see Figure 3

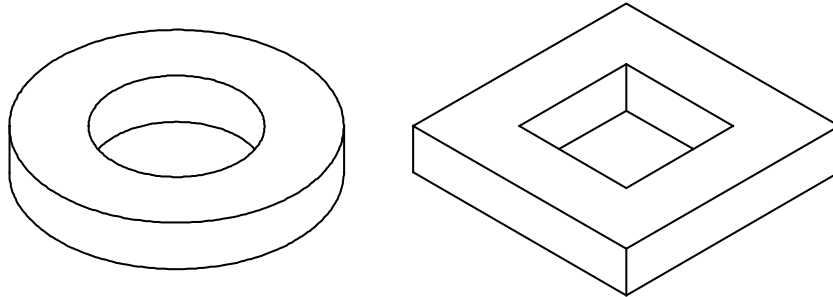

Figure 3 — Examples of completely bound openings

5.2.2.2

partially bound opening

an opening that is partially surrounded by the material of the product, see Figure 4

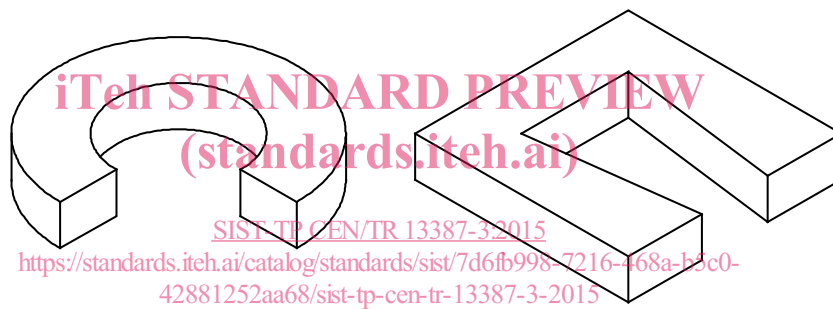

Figure 4 — Examples of partially bound openings

5.2.2.3

V shaped opening

an opening where there is a slot that narrows towards the bottom, see Figure 5

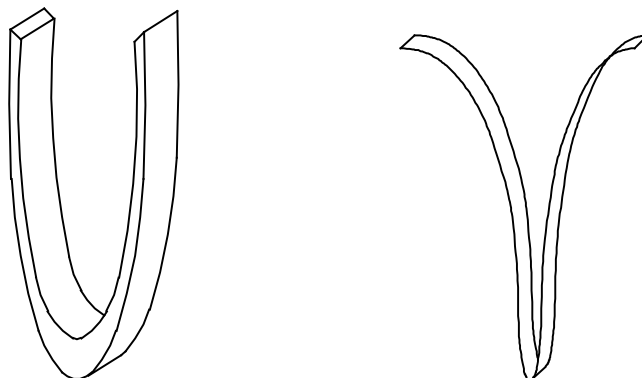

Figure 5 — Examples of V shaped openings

CEN/TR 13387-3:2015 (E)

5.2.2.4

irregular shaped opening

an opening that does not have a symmetrical shape, see Figure 6.

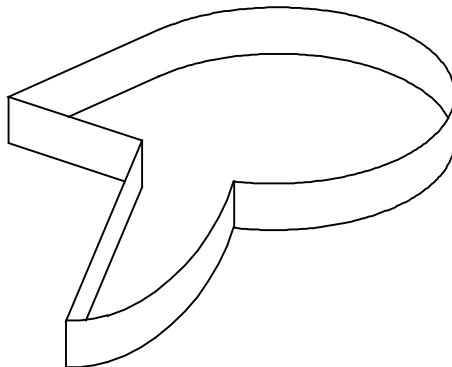

Figure 6 — Example of an irregular shaped opening

5.3 Requirements

When tested in accordance with 5.5.1 or 5.5.2, if openings allow passage of the small probe, the large probe should pass through. The opening that allows the large probe to pass completely through should comply with the requirement for partially bound, V and irregular shaped openings when tested in accordance with 5.5.3.

Partially bound, V and irregular shaped openings should be constructed so that:

- a) portion B of the template does not enter the opening when tested in accordance with 5.5.3, see Figure 11 and Figure 12; or
- b) the apex of portion A of the template contacts the base of the opening when tested in accordance with 5.5.3, see Figure 13.

5.4 Test equipment

5.4.1 Probe philosophy

To cover all aspects of head and neck entrapment four types of probes are required, the hip probe, the small head probe, the large head probe and the template for partially bound and V-shaped openings. The size of individual probes is determined to meet the age range of the child, see the figures and tables for the various probes.

5.4.2 Hip probe

The hip probe, Figure 7, represents the hip of the smallest child in each age range. The probe size corresponds to the size of the child as follows:

- dimension 'A' represents the hip breadth;
- dimension 'B' represents hip depth;
- dimension 'C' represents the radius C after calculation based on hip circumference.

The dimensions of the hip probe are based on the anthropometric data, see Table 2.

Table 2 — Hip probe corresponding to smallest child

Age Months	A	B	C
0 to 2	101	42	10
3 to 5	105	65	23
6 to 8	124	67	23

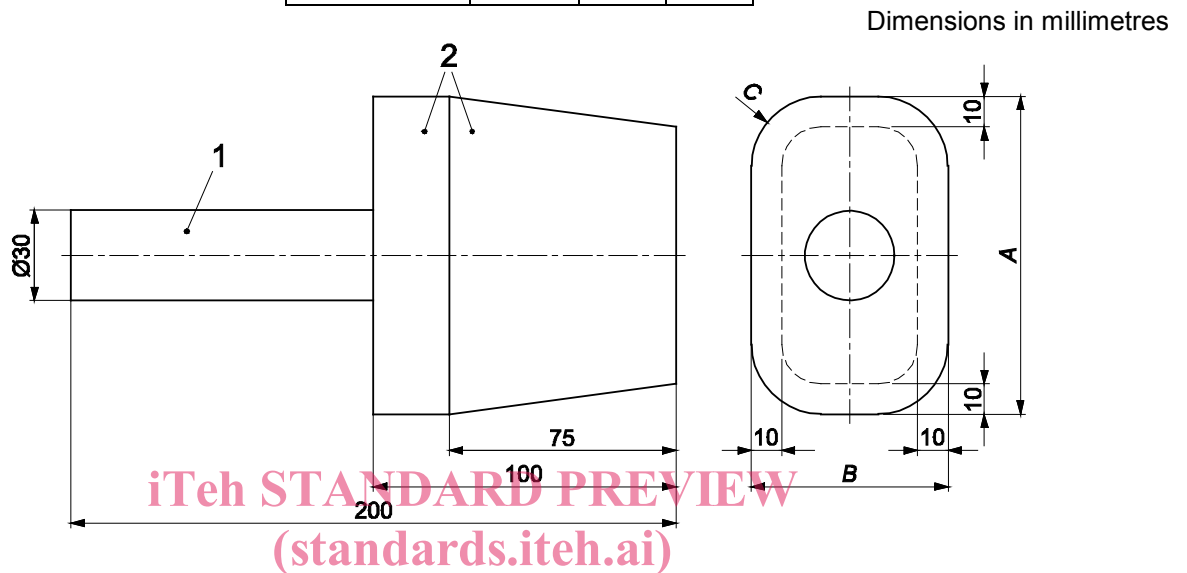

Key

- 1 handle
2 Hip probe

[SIST-TP CEN/TR 13387-3:2015](https://standards.iteh.ai/catalog/standards/sist/7d6fb998-7216-468a-b5c0-42881252aa68/sist-tp-cen-tr-13387-3-2015)

<https://standards.iteh.ai/catalog/standards/sist/7d6fb998-7216-468a-b5c0-42881252aa68/sist-tp-cen-tr-13387-3-2015>

Figure 7 — Hip probe

5.4.3 Small head probe

The small head probe, Figure 8, represents the head of the smallest child in each age range. The probe size corresponds to the child size as follows:

- dimension 'a' represents head breadth;
- dimension 'b' represents head length;
- dimension 'c' represents head height;

The dimensions of the small head probe are based on anthropometric data, see Table 3.