



Designation: C1273 – 05

# Standard Test Method for Tensile Strength of Monolithic Advanced Ceramics at Ambient Temperatures<sup>1</sup>

This standard is issued under the fixed designation C1273; the number immediately following the designation indicates the year of original adoption or, in the case of revision, the year of last revision. A number in parentheses indicates the year of last reapproval. A superscript epsilon ( $\epsilon$ ) indicates an editorial change since the last revision or reapproval.

## 1. Scope

1.1 This test method covers the determination of tensile strength under uniaxial loading of monolithic advanced ceramics at ambient temperatures. This test method addresses, but is not restricted to, various suggested test specimen geometries as listed in the appendix. In addition, test specimen fabrication methods, testing modes (force, displacement, or strain control), testing rates (force rate, stress rate, displacement rate, or strain rate), allowable bending, and data collection and reporting procedures are addressed. Note that tensile strength as used in this test method refers to the tensile strength obtained under uniaxial loading.

1.2 This test method applies primarily to advanced ceramics that macroscopically exhibit isotropic, homogeneous, continuous behavior. While this test method applies primarily to monolithic advanced ceramics, certain whisker- or particle-reinforced composite ceramics as well as certain discontinuous fiber-reinforced composite ceramics may also meet these macroscopic behavior assumptions. Generally, continuous fiber ceramic composites (CFCCs) do not macroscopically exhibit isotropic, homogeneous, continuous behavior and application of this practice to these materials is not recommended.

1.3 Values expressed in this test method are in accordance with the International System of Units (SI) and **SI10-02 IEEE/ASTM SI 10**.

1.4 *This standard does not purport to address all of the safety concerns, if any, associated with its use. It is the responsibility of the user of this standard to establish appropriate safety and health practices and determine the applicability of regulatory limitations prior to use.* Specific precautionary statements are given in Section 7.

<sup>1</sup> This test method is under the jurisdiction of ASTM Committee C28 on Advanced Ceramics and is the direct responsibility of Subcommittee C28.01 on Mechanical Properties and Performance.

Current edition approved June 1, 2005. Published July 2005. Originally approved in 1994. Last previous edition approved in 2000 as C1273 – 95a (2000). DOI: 10.1520/C1273-05.

## 2. Referenced Documents

### 2.1 ASTM Standards:<sup>2</sup>

- C1145 Terminology of Advanced Ceramics
- C1161 Test Method for Flexural Strength of Advanced Ceramics at Ambient Temperature
- C1239 Practice for Reporting Uniaxial Strength Data and Estimating Weibull Distribution Parameters for Advanced Ceramics
- C1322 Practice for Fractography and Characterization of Fracture Origins in Advanced Ceramics
- D3379 Test Method for Tensile Strength and Young's Modulus for High-Modulus Single-Filament Materials
- E4 Practices for Force Verification of Testing Machines
- E6 Terminology Relating to Methods of Mechanical Testing
- E83 Practice for Verification and Classification of Extensometer Systems
- E337 Test Method for Measuring Humidity with a Psychrometer (the Measurement of Wet- and Dry-Bulb Temperatures)
- E1012 Practice for Verification of Test Frame and Specimen Alignment Under Tensile and Compressive Axial Force Application
- SI10-02 IEEE/ASTM SI 10 American National Standard for Use of the International System of Units (SI): The Modern Metric System

## 3. Terminology

3.1 Definitions—The definitions of terms relating to tensile testing appearing in Terminology E6 apply to the terms used in this test method on tensile testing. The definitions of terms relating to advanced ceramics testing appearing in Terminology C1145 apply to the terms used in this test method. Pertinent definitions as listed in Practice C1239, Practice E1012, Terminology C1145, and Terminology E6 are shown in the following with the appropriate source given in parentheses. Additional terms used in conjunction with this test method are defined in the following:

<sup>2</sup> For referenced ASTM standards, visit the ASTM website, www.astm.org, or contact ASTM Customer Service at service@astm.org. For *Annual Book of ASTM Standards* volume information, refer to the standard's Document Summary page on the ASTM website.

3.1.1 *advanced ceramic*—a highly engineered, high performance predominately nonmetallic, inorganic, ceramic material having specific functional attributes. **C1145**

3.1.2 *axial strain*—the average of longitudinal strains measured at the surface on opposite sides of the longitudinal axis of symmetry of the specimen by two strain-sensing devices located at the mid length of the reduced section. **E1012**

3.1.3 *bending strain*—the difference between the strain at the surface and the axial strain. In general, the bending strain varies from point to point around and along the reduced section of the specimen. **E1012**

3.1.4 *breaking force*—the force at which fracture occurs. **E6**

3.1.5 *fractography*—means and methods for characterizing a fractured specimen or component. **C1145**

3.1.6 *fracture origin*—the source from which brittle fracture commences. **C1145**

3.1.7 *percent bending*—the bending strain times 100 divided by the axial strain. **E1012**

3.1.8 *slow crack growth (SCG)*—subcritical crack growth (extension) which may result from, but is not restricted to, such mechanisms as environmentally-assisted stress corrosion or diffusive crack growth. **C1145**

3.1.9 *tensile strength*,—  $S_u$ —the maximum tensile stress which a material is capable of sustaining. Tensile strength is calculated from the maximum force during a tension test carried to rupture and the original cross-sectional area of the specimen. **E6**

#### 4. Significance and Use

4.1 This test method may be used for material development, material comparison, quality assurance, characterization, and design data generation.

4.2 High strength, monolithic advanced ceramic materials generally characterized by small grain sizes (<50  $\mu\text{m}$ ) and bulk densities near the theoretical density are candidates for load-bearing structural applications requiring high degrees of wear and corrosion resistance, and high temperature strength. Although flexural test methods are commonly used to evaluate strength of advanced ceramics, the non-uniform stress distribution of the flexure test specimen limits the volume of material subjected to the maximum applied stress at fracture. Uniaxially-loaded tensile strength tests provide information on strength-limiting flaws from a greater volume of uniformly stressed material.

4.3 Although the volume or surface area of material subjected to a uniform tensile stress for a single uniaxially-loaded tensile test may be several times that of a single flexure test specimen, the need to test a statistically significant number of tensile test specimens is not obviated. Therefore, because of the probabilistic strength distributions of brittle materials such as advanced ceramics, a sufficient number of test specimens at each testing condition is required for statistical analysis and eventual design, with guidelines for sufficient numbers provided in this test method. Note that size-scaling effects as discussed in Practice C1239 will affect the strength values. Therefore, strengths obtained using different recommended tensile test specimens with different volumes or surface areas of material in the gage sections will be different due to these

size differences. Resulting strength values can be scaled to an effective volume or surface area of unity as discussed in Practice C1239.

4.4 Tensile tests provide information on the strength and deformation of materials under uniaxial tensile stresses. Uniform stress states are required to effectively evaluate any non-linear stress-strain behavior which may develop as the result of testing mode, testing rate, processing or alloying effects, or environmental influences. These effects may be consequences of stress corrosion or subcritical (slow) crack growth which can be minimized by testing at appropriately rapid rates as outlined in this test method.

4.5 The results of tensile tests of test specimens fabricated to standardized dimensions from a particular material or selected portions, or both, of a part may not totally represent the strength and deformation properties of the entire, full-size end product or its in-service behavior in different environments.

4.6 For quality control purposes, results derived from standardized tensile test specimens can be considered to be indicative of the response of the material from which they were taken for given primary processing conditions and post-processing heat treatments.

4.7 The tensile strength of a ceramic material is dependent on both its inherent resistance to fracture and the presence of flaws. Analysis of fracture surfaces and fractography, though beyond the scope of this test method, is highly recommended for all purposes, especially for design data.

#### 5. Interferences

5.1 Test environment (vacuum, inert gas, ambient air, etc.) including moisture content (for example, relative humidity) may have an influence on the measured tensile strength. In particular, the behavior of materials susceptible to slow crack growth fracture will be strongly influenced by test environment and testing rate. Testing to evaluate the maximum strength potential of a material should be conducted in inert environments or at sufficiently rapid testing rates, or both, so as to minimize slow crack growth effects. Conversely, testing can be conducted in environments and testing modes and rates representative of service conditions to evaluate material performance under use conditions. When testing is conducted in uncontrolled ambient air with the intent of evaluating maximum strength potential, relative humidity and temperature must be monitored and reported. Testing at humidity levels >65 % relative humidity (RH) is not recommended and any deviations from this recommendation must be reported.

5.2 Surface preparation of test specimens can introduce fabrication flaws that may have pronounced effects on tensile strength. Machining damage introduced during test specimen preparation can be either a random interfering factor in the determination of ultimate strength of pristine material (that is, increase frequency of surface initiated fractures compared to volume initiated fractures), or an inherent part of the strength characteristics to be measured. Surface preparation can also lead to the introduction of residual stresses. Universal or standardized test methods of surface preparation do not exist. It should be understood that final machining steps may or may not negate machining damage introduced during the early

coarse or intermediate machining. Thus, test specimen fabrication history may play an important role in the measured strength distributions and should be reported.

5.3 Bending in uniaxial tensile tests can cause or promote non-uniform stress distributions with maximum stresses occurring at the test specimen surface leading to non-representative fractures originating at surfaces or near geometrical transitions. In addition, if strains or deformations are measured at surfaces where maximum or minimum stresses occur, bending may introduce over or under measurement of strains. Similarly, fracture from surface flaws may be accentuated or muted by the presence of the non-uniform stresses caused by bending.

## 6. Apparatus

6.1 *Testing Machines*—Machines used for tensile testing shall conform to the requirements of Practices E4. The forces used in determining tensile strength shall be accurate within  $\pm 1\%$  at any force within the selected force range of the testing machine as defined in Practices E4. A schematic showing pertinent features of the tensile testing apparatus is shown in Fig. 1.

### 6.2 Gripping Devices:

6.2.1 *General*—Various types of gripping devices may be used to transmit the measured force applied by the testing machine to the test specimens. The brittle nature of advanced ceramics requires a uniform interface between the grip components and the gripped section of the test specimen. Line or point contacts and non-uniform pressure can produce Hertzian-type stresses leading to crack initiation and fracture of the test specimen in the gripped section. Gripping devices can be

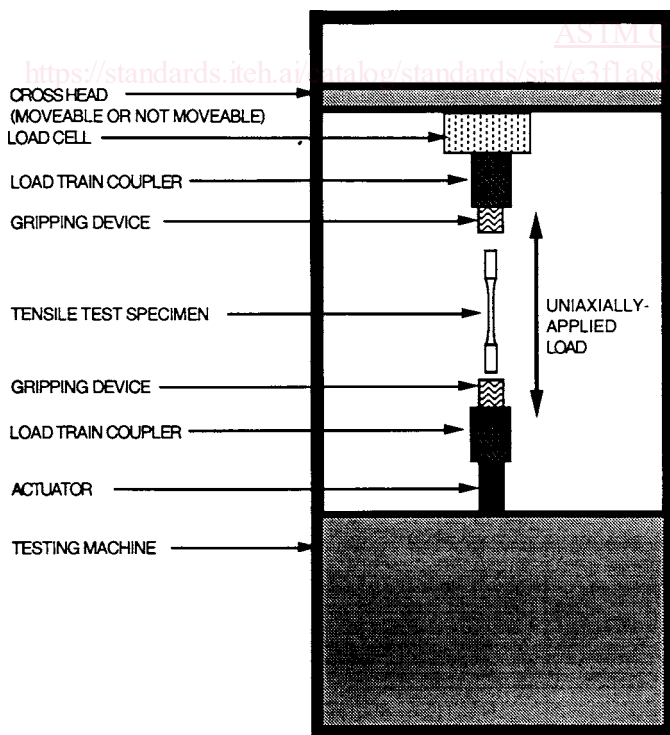

FIG. 1 Schematic Diagram of One Possible Apparatus for Conducting a Uniaxially-Loaded Tensile Test

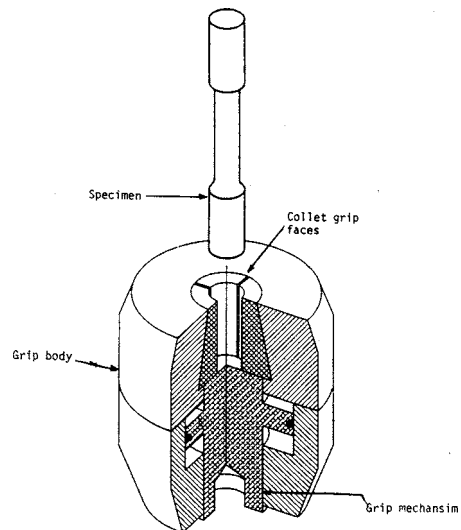

FIG. 2 Example of a Smooth, Split Collet Active Gripping System for Cylindrical Test Specimens

classified generally as those employing active and those employing passive grip interfaces as discussed in the following sections.

6.2.2 *Active Grip Interfaces*—Active grip interfaces require a continuous application of a mechanical, hydraulic, or pneumatic force to transmit the force applied by the test machine to the test specimen. Generally, these types of grip interfaces cause a force to be applied normal to the surface of the gripped section of the test specimen. Transmission of the uniaxial force applied by the test machine is then accomplished by friction between the test specimen and the grip faces. Thus, important aspects of active grip interfaces are uniform contact between the gripped section of the test specimen and the grip faces and constant coefficient of friction over the grip/specimen interface.

6.2.2.1 For cylindrical test specimens, a one-piece split-collet arrangement acts as the grip interface (1, 2)<sup>3</sup> as illustrated in Fig. 2. Generally, close tolerances are required for concentricity of both the grip and test specimen diameters. In addition, the diameter of the gripped section of the test specimen and the unclamped, open diameter of the grip faces must be within similarly close tolerances to promote uniform contact at the test specimen/grip interface. Tolerances will vary depending on the exact configuration as shown in the appropriate test specimen drawings.

6.2.2.2 For flat test specimens, flat-face, wedge-grip faces act as the grip interface as illustrated in Fig. 3. Generally, close tolerances are required for the flatness and parallelism as well as wedge angle of the grip faces. In addition, the thickness, flatness, and parallelism of the gripped section of the test specimen must be within similarly close tolerances to promote uniform contact at the test specimen/grip interface. Tolerances will vary depending on the exact configuration as shown in the appropriate test specimen drawings.

<sup>3</sup> The boldface numbers given in parentheses refer to a list of references at the end of the text.

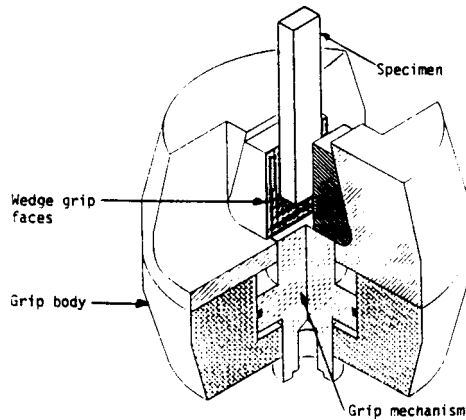

FIG. 3 Example of a Smooth, Wedge Active Gripping System for Flat Test Specimens

6.2.3 *Passive Grip Interfaces*—Passive grip interfaces transmit the force applied by the test machine to the test specimen through a direct mechanical link. Generally, these mechanical links transmit the test forces to the test specimen via geometrical features of the test specimens such as button-head fillets, shank shoulders, or holes in the gripped head. Thus, the important aspect of passive grip interfaces is uniform contact between the gripped section of the test specimen and the grip faces.

6.2.3.1 For cylindrical test specimens, a multi-piece split collet arrangement acts as the grip interface at button-head fillets of the test specimen (3) as illustrated in Fig. 4. Because of the limited contact area at the test specimen/grip interface, soft, deformable collet materials may be used to conform to the exact geometry of the test specimen. In some cases tapered collets may be used to transfer the axial force into the shank of the test specimen rather than into the button-head radius (3). Moderately close tolerances are required for concentricity of both the grip and test specimen diameters. In addition, tolerances on the collet height must be maintained to promote uniform axial-loading at the test specimen/grip interface.

Tolerances will vary depending on the exact configuration as shown in the appropriate test specimen drawings.

6.2.3.2 For flat test specimens, pins or pivots act as grip interfaces at either the shoulders of the test specimen shank or at holes in the gripped test specimen head (4, 5, 6). Close tolerances are required of shoulder radii and grip interfaces to promote uniform contact along the entire test specimen/grip interface as well as to provide for non-eccentric loading as shown in Fig. 5. Moderately close tolerances are required for longitudinal coincidence of the pin and hole centerlines as illustrated in Fig. 6.

6.3 *Load Train Couplers*:

6.3.1 *General*—Various types of devices (load train couplers) may be used to attach the active or passive grip interface assemblies to the testing machine. The load train couplers in conjunction with the type of gripping device play major roles in the alignment of the load train and thus subsequent bending imposed in the test specimen. Load train couplers can be classified as fixed and nonfixed as discussed in the following sections. Note that use of well-aligned fixed or self-aligning non fixed couplers does not automatically guarantee low bending in the gage section of the tensile test specimen. Well-aligned fixed or self-aligning non fixed couplers provide for well aligned load trains, but the type and operation of grip interfaces as well as the as-fabricated dimensions of the tensile test specimen can add significantly to the final bending imposed in the gage section of the test specimen.

6.3.1.1 Regardless of which type of coupler is used, alignment of the testing system must be verified as a minimum at the beginning and end of a test series. An additional verification of alignment is recommended, although not required, at the middle of the test series. Either a dummy or actual test specimen and the alignment verification procedures detailed in the appendix must be used. Allowable bending requirements are discussed in 6.4. Tensile test specimens used for alignment verification should be equipped with a recommended eight

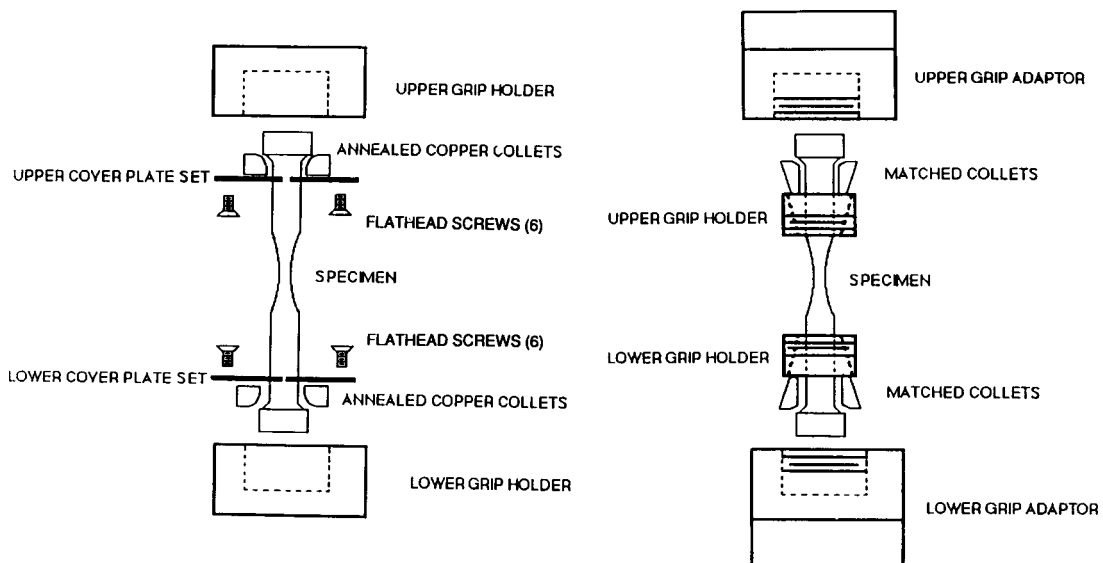

FIG. 4 Examples of Straight- and Tapered-Collet Passive Gripping Systems for Cylindrical Test Specimens (3)



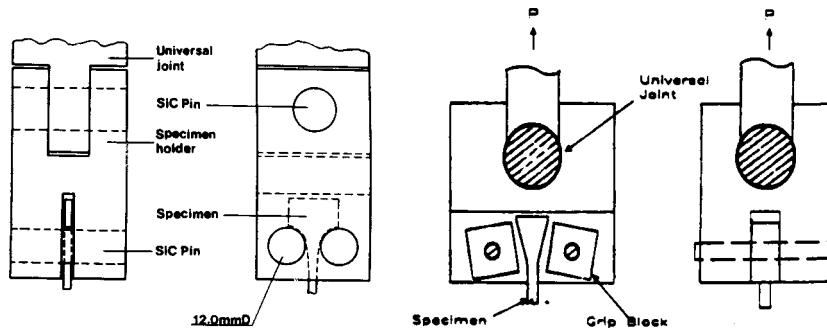

FIG. 5 Examples of Shoulder-Loaded, Passive Gripping Systems for Flat Test Specimens (4, 5)

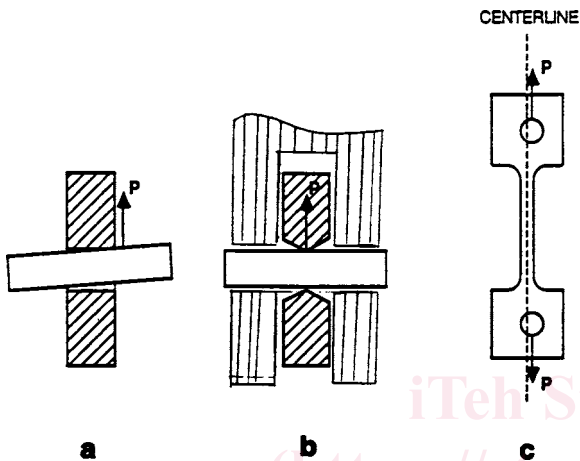

FIG. 6 Example of a Pin-Loaded, Passive Gripping System for Flat Test Specimens (16)

separate longitudinal strain gages to determine bending contributions from both eccentric and angular misalignment of the grip heads. (Although it is possible to use a minimum of six separate longitudinal strain gages for test specimens with circular cross sections, eight strain gages are recommended here for simplicity and consistency in describing the technique for both circular and rectangular cross sections). If dummy test specimens are used for alignment verification, they should have the same geometry and dimensions of the actual test specimens as well as the same mechanical properties (that is, elastic modulus, hardness, etc.) as the test material to ensure similar axial and bending stiffness characteristics as the actual test specimen and material.

**6.3.2 Fixed Load Train Couplers**—Fixed couplers may incorporate devices that require either a one-time, pre-test alignment adjustment of the load train which remains constant for all subsequent tests or an *in-situ*, pre-test alignment of the load train that is conducted separately for each test specimen and each test. Such devices (7, 8) usually employ angularity and concentricity adjusters to accommodate inherent load train misalignments. Regardless of which method is used, alignment verification must be performed as discussed in 6.3.1.1.

**6.3.3 Non Fixed Load Train Couplers**—Non fixed couplers may incorporate devices that promote self-alignment of the load train during the movement of the crosshead or actuator. Generally such devices rely upon freely moving linkages to eliminate applied moments as the load train components are loaded. Knife edges, universal joints, hydraulic couplers or air

bearings are examples (4, 7, 9, 10, 11) of such devices. Examples of two such devices are shown in Fig. 7. Although non fixed load train couplers are intended to be self-aligning and thus eliminate the need to evaluate the bending in the test specimen for each test, the operation of the couplers must be verified as discussed in 6.3.1.1.

**6.4 Allowable Bending**—Analytical and empirical studies (3) have concluded that for negligible effects on the estimates of the strength distribution parameters (for example, Weibull modulus,  $\hat{m}$ , and characteristic strength,  $\hat{\sigma}_\theta$ ) allowable percent bending as defined in Practice E1012 should not exceed five. These conclusions (3) assume that tensile strength fractures are due to fracture origins in the volume of the material, all tensile test specimens experienced the same level of bending and that Weibull modulus,  $\hat{m}$ , was constant. Thus, the maximum allowable percent bending at fracture for test specimens tested under this test method shall not exceed five. However, it should be noted that unless all test specimens are properly strain gaged and percent bending monitored until fracture, there will be no record of percent bending at fracture for each test specimen. Therefore, the testing system shall be verified using the procedure detailed in the appendix such that percent bending does not exceed five at a mean strain equal to one half the anticipated strain at fracture. This verification shall be conducted at a minimum at the beginning and each of each test series as recommended in previous sections. An additional verification of alignment is recommended, although not required, at the middle of the test series.

**6.5 Data Acquisition**—At the minimum, an autographic record of applied force versus time should be obtained. Either analog chart recorders or digital data acquisition systems can be used for this purpose although a digital record is recommended for ease of later data analysis. Ideally, an analog chart recorder or plotter should be used in conjunction with the digital data acquisition system to provide an immediate record of the test as a supplement to the digital record. Recording devices shall be accurate to within 1 % for total testing system, including readout unit, as specified in Practices E4 and should have a minimum data acquisition rate of 10 Hz with a response of 50 Hz deemed more than sufficient.

**6.5.1** Where strain or elongation of the gage section are also measured these values should be recorded either similarly to the force or as independent variables of force. Cross-head displacement of the test machine may also be recorded but

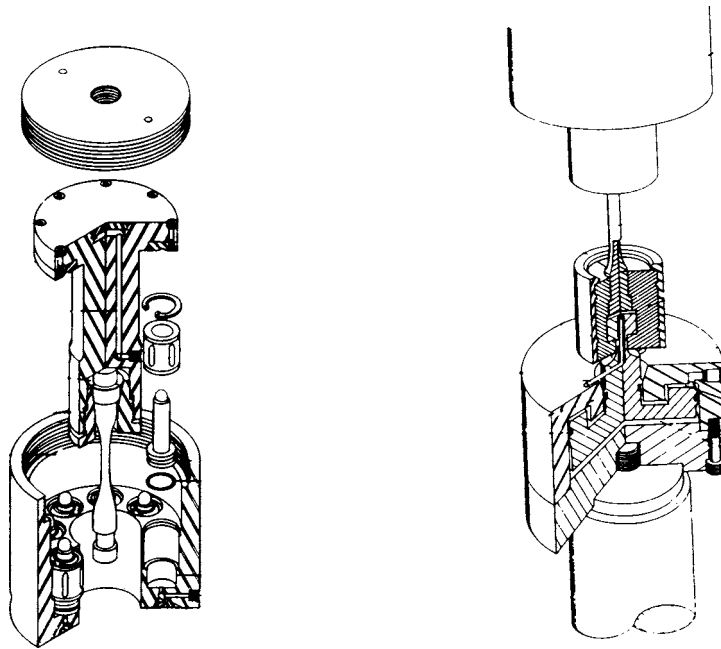

FIG. 7 Examples of Hydraulic, Self-Aligning, Non Fixed Load Train Couplers (9, 10)

should not be used to define displacement or strain in the gage section especially when self-aligning couplers are used in the load train.

6.6 *Dimension-Measuring Devices*—Micrometers and other devices used for measuring linear dimensions should be accurate and precise to at least one half the smallest unit to which the individual dimension is required to be measured. For the purposes of this test method, cross sectional dimensions should be measured to within 0.02 mm requiring dimension measuring devices with accuracies of 0.01 mm.

## 7. Precaution

7.1 During the conduct of this test method, the possibility of flying fragments of broken test material is quite high. The brittle nature of advanced ceramics and the release of strain energy contribute to the potential release of uncontrolled fragments upon fracture. Means for containment and retention of these fragments for later fractographic reconstruction and analysis is highly recommended.

## 8. Test Specimens

### 8.1 Test Specimen Geometry:

8.1.1 *General*—The geometry of tensile test specimen is dependent on the ultimate use of the tensile strength data. For example, if the tensile strength of an as-fabricated component is required the dimensions of the resulting tensile test specimen may reflect the thickness, width, and length restrictions of the component. If it is desired to evaluate the effects of inherent flaw distributions for a particular material manufactured from a particular processing route, then the size of the test specimen and resulting gage section will reflect the desired volume to be sampled. In addition, grip interfaces and load train couplers as discussed in Section 6 will influence the final design of the test specimen geometry.

8.1.1.1 Fig. 8 illustrates a range of tensile test specimen geometries that have been applied to testing advanced ceramics. Note that Fig. 8 provides only a sampling of possible configurations past or present. The following subsections discuss the more common, and thus proven, of these test specimen geometries although any geometry is acceptable if it meets the gripping and bending requirements of this test method. If deviations from the recommended geometries are made, a stress analysis of the test specimen should be conducted to ensure that stress concentrations that could lead to undesired fractures outside the gage section do not exist.

8.1.2 *Cylindrical Tensile Test Specimens*—Cylindrical test specimens are generally fabricated from rods of material and offer the potential of testing the largest volume of the various tensile test specimens. In addition, the size of the test specimen lends itself to more readily evaluating the mechanical behavior of a material for engineering purposes. Disadvantages include the relatively large amount of material required for the starting billet, the large amount of material which must be removed during test specimen fabrication, and the need to fabricate the test specimen cylindrically usually requiring numerically controlled grinding machines, all of which may add substantially to the total cost per test specimen. Gripped ends include various types of button-heads (3, 7 to 12) as shown in Fig. 9, Fig. 10, and Fig. 11. In addition, straight shank geometries have been successfully used (1, 2) as shown in Fig. 12 and Fig. 13. Important tolerances for the cylindrical tensile test specimens include concentricity and cylindricity that will vary depending on the exact configuration as shown in the appropriate test specimen drawings.