



# Standard Specification for Thermoplastic Well Casing Pipe and Couplings Made in Standard Dimension Ratios (SDR), SCH 40 and SCH 80<sup>1</sup>

This standard is issued under the fixed designation F480; the number immediately following the designation indicates the year of original adoption or, in the case of revision, the year of last revision. A number in parentheses indicates the year of last reapproval. A superscript epsilon ( $\epsilon$ ) indicates an editorial change since the last revision or reapproval.

*This standard has been approved for use by agencies of the Department of Defense.*

## 1. Scope

1.1 This specification covers water well casing pipe and couplings made from thermoplastic materials in standard dimension ratios (SDR), SCH 40 and SCH 80.

1.2 Specifications are provided for the application of these materials to water well and ground water monitoring applications. Flush threaded joint systems are included for screen and casing used primarily in the construction of ground water monitoring wells (see Practice [D5092](#)).

1.3 The values stated in inch-pound units are to be regarded as the standard. The values given in parentheses are provided for information only ([IEEE/ASTM SI 10](#)).

NOTE 1—Certain field conditions may require alternative materials to ensure safe long-term use. The user should consult federal, state, and local codes governing the use of thermoplastic materials for well casing or monitor pipe.

NOTE 2—This standard specifies dimensional, performance and test requirements for plumbing and fluid handling applications, but does not address venting of combustion gases.

1.4 Although the pipe sizes and SDR values listed in this specification are generally available, numerous other plastic pipes in Schedule 40 and 80 wall, other SDR values and various outside diameters have been used for well casing. Such products are often selected because they fulfill certain needs and [Annex A1](#) includes a list of these Plastic Pipe Well Casing Specials.

1.5 The following safety hazards caveat pertains only to the test method portion, Section 6, of this specification: *This standard does not purport to address all of the safety concerns, if any, associated with its use. It is the responsibility of the user of this standard to establish appropriate safety and health practices and determine the applicability of regulatory limitations prior to use.*

<sup>1</sup> This specification is under the jurisdiction of ASTM Committee [F17](#) on Plastic Piping Systems and is the direct responsibility of Subcommittee [F17.61](#) on Water. Current edition approved Aug. 1, 2006. Published August 2006. Originally approved in 1976. Last previous edition approved in 2006 as F480 – 06a. DOI: 10.1520/F0480-06B.

## 2. Referenced Documents

### 2.1 ASTM Standards:<sup>2</sup>

- [D618](#) Practice for Conditioning Plastics for Testing
- [D638](#) Test Method for Tensile Properties of Plastics
- [D653](#) Terminology Relating to Soil, Rock, and Contained Fluids
- [D1527](#) Specification for Acrylonitrile-Butadiene-Styrene (ABS) Plastic Pipe, Schedules 40 and 80
- [D1600](#) Terminology for Abbreviated Terms Relating to Plastics
- [D1784](#) Specification for Rigid Poly(Vinyl Chloride) (PVC) Compounds and Chlorinated Poly(Vinyl Chloride) (CPVC) Compounds
- [D1785](#) Specification for Poly(Vinyl Chloride) (PVC) Plastic Pipe, Schedules 40, 80, and 120
- [D1892](#) Specification for Styrene-Butadiene Molding and Extrusion Materials<sup>3</sup>
- [D1898](#) Practice for Sampling of Plastics<sup>3</sup>
- [D2122](#) Test Method for Determining Dimensions of Thermoplastic Pipe and Fittings
- [D2235](#) Specification for Solvent Cement for Acrylonitrile-Butadiene-Styrene (ABS) Plastic Pipe and Fittings
- [D2241](#) Specification for Poly(Vinyl Chloride) (PVC) Pressure-Rated Pipe (SDR Series)
- [D2282](#) Specification for Acrylonitrile-Butadiene-Styrene (ABS) Plastic Pipe<sup>4</sup>
- [D2412](#) Test Method for Determination of External Loading Characteristics of Plastic Pipe by Parallel-Plate Loading
- [D2444](#) Test Method for Determination of the Impact Resistance of Thermoplastic Pipe and Fittings by Means of a Tup (Falling Weight)

<sup>2</sup> For referenced ASTM standards, visit the ASTM website, [www.astm.org](http://www.astm.org), or contact ASTM Customer Service at [service@astm.org](mailto:service@astm.org). For *Annual Book of ASTM Standards* volume information, refer to the standard's Document Summary page on the ASTM website.

<sup>3</sup> Withdrawn.

<sup>4</sup> Withdrawn. The last approved version of this historical standard is referenced on [www.astm.org](http://www.astm.org).

- D2564** Specification for Solvent Cements for Poly(Vinyl Chloride) (PVC) Plastic Piping Systems
- D2855** Practice for Making Solvent-Cemented Joints with Poly(Vinyl Chloride) (PVC) Pipe and Fittings
- D3122** Specification for Solvent Cements for Styrene-Rubber (SR) Plastic Pipe and Fittings
- D3965** Specification for Rigid Acrylonitrile-Butadiene-Styrene (ABS) Materials for Pipe and Fittings
- D5092** Practice for Design and Installation of Ground Water Monitoring Wells
- F402** Practice for Safe Handling of Solvent Cements, Primers, and Cleaners Used for Joining Thermoplastic Pipe and Fittings
- F412** Terminology Relating to Plastic Piping Systems
- IEEE/ASTM SI 10** American National Standard for Use of the International System of Units (SI): The Modern Metric System

## 2.2 ANSI Standards:

- B1.5** ACME Screw Threads<sup>5</sup>
- B1.8** Stub ACME Screw Threads<sup>5</sup>
- B1.9** Buttress Inch Screw Threads<sup>5</sup>

## 2.3 Federal Standard:

- FED-STD-123** Marking for Shipment (Civil Agencies)<sup>6</sup>

## 2.4 Military Standard:

- MIL-STD-129** Marking for Shipment and Storage<sup>7</sup>

## 2.5 Other Standards:

- Screw-Threads Standards for Federal Services 1957**, Handbook H28, Part III<sup>7</sup>
- NSF 14** Plastic Piping System Components and Related Materials
- NSF 61** Drinking Water System Components<sup>8</sup>

## 3. Terminology

3.1 Definitions are in accordance with Terminology **F412** and abbreviations are in accordance with Terminology **D1600**, unless otherwise specified. The abbreviation for acrylonitrile-butadiene-styrene plastic is ABS. The abbreviation for poly(vinyl chloride) is PVC. The abbreviation for styrene-rubber is SR.

3.2 Ground water investigation terms are in accordance with Terminology **D653**.

## 4. Classification

4.1 Well casing is produced in either plain end, belled end, or threaded, and is used for water wells, ground water monitoring, leak detection, recovery systems, dewatering systems, and waste disposal.

## 5. Materials and Manufacture

5.1 *Specification*—The material described shall meet or exceed the requirements of (1) Specification **D3965** for ABS

<sup>5</sup> Available from American National Standards Institute (ANSI), 25 W. 43rd St., 4th Floor, New York, NY 10036. Sponsored the American Society of Mechanical Engineers (ASME), ASME International Headquarters, Three Park Ave., New York, NY 10016-5990.

<sup>6</sup> Available from Standardization Documents Order Desk, Bldg. 4 Section D, 700 Robbins Ave., Philadelphia, PA 19111-5094.

<sup>7</sup> Available from the Superintendent of Documents, Washington, DC.

<sup>8</sup> NSF International, PO Box 130140, Ann Arbor, MI 48113-0140.

with a cell classification of 44322 or 33333, (2) Specification **D1784** for PVC with a cell classification of 12454 or 14333, or (3) Specification **D1892** for SR with a cell classification of 4434A. The material so described shall be approved for potable water.

NOTE 3—Caution should be exercised to control heat of hydration during grouting as thermoplastic materials are heat sensitive. Accelerators tend to increase the heat of hydration and are not recommended.

5.2 Acrylonitrile-butadiene-styrene (ABS) well casing pipe and couplings plastic shall be virgin plastic produced by the original compounder (see Specification **D1527**). The minimum butadiene content is 6 %; the minimum acrylonitrile content is 15 %; the minimum styrene or substituted styrene content, or both, is 15 %; and the maximum content of other monomers is 5 % and lubricants, stabilizers, and colorants.

5.3 Poly(vinyl chloride) (PVC) well casing pipe and couplings plastic shall be made of virgin plastic produced by the original compounder. It shall contain poly(vinyl chloride) homopolymer, and such additives—stabilizers, lubricants, processing aids, impact improvers, and colorants—as needed to provide the required processing and toughness characteristics (see Test Method **D638**).

5.4 The SR plastics compound shall contain at least 50 % styrene plastics, combined with rubbers to a minimum rubber content of 5 %, and compounding materials such as antioxidants and lubricants, and may contain up to 15 % acrylonitrile combined in the styrene plastics or rubbers, or both. The rubbers shall be of the poly-butadiene or butadiene-styrene type, or both, with a maximum styrene content of 25 % or nitrile type, or both. The combined styrene plastics and rubber content shall be not less than 90 %.

5.5 *Rework Material*—Clean rework material generated from the manufacturer's own well casing pipe and couplings production may be used by the same manufacturer, provided the well casing pipe and couplings produced meet all the requirements of this specification.

## 5.6 Solvent Cement:

5.6.1 *Specification*—The solvent cement shall meet the requirements of Specification **D2235** for ABS, Specification **D2564** for PVC, or Specification **D3122** for SR (see Supplementary Requirements S3).

## 6. Requirements

6.1 *Workmanship*—The pipe shall be homogeneous throughout and essentially uniform in color, opacity, density, and other properties. The inside and outside surfaces shall be semi-matte or glossy in appearance (depending on the type of plastic) and free of chalking, sticky, or tacky material. The surfaces shall be free of excessive bloom, that is, slight bloom is acceptable. The pipe walls shall be free of cracks, holes, blisters, voids, foreign inclusion, or other defects that are visible to the naked eye and that may affect the wall integrity. Machined slots or holes deliberately placed in pipe are acceptable. Bloom or chalking may develop in pipe exposed to direct rays of the sun (ultraviolet radiant energy) for extended periods, and consequently these requirements do not apply to pipe after extended exposure to direct rays of the sun.

6.1.1 *Ground Water Investigations*—Pipe manufactured into products used in ground water investigations should have surfaces that are visually free of oils, grease, dust, and marks imparted as a result of the manufacturing process.

6.2 *Well Casing Pipe:*

6.2.1 *Dimensions*—The outside diameter and wall thickness of the well casing pipe shall meet the requirements given in **Table 1** or **Table 2** when measured in accordance with Test Method **D2122**. (See Specification **D2282**.)

6.2.2 *Wall Thickness Eccentricity*—The wall thickness eccentricity of the pipe shall be within 12 %.

6.2.3 *Length*—The well casing pipe shall be in either 10- or 20-ft (3.05- or 6.10-m) lengths, unless otherwise specified. The allowable tolerance on length shall be  $\pm 1/2$  ,  $-0$  in. ( $\pm 13$ ,  $-0$  mm) when measured in accordance with Test Method **D2122**.

6.2.4 *Flush Joint Threaded Length*—If specified by the manufacturer or purchaser, the assembled length of flush threaded casing or screen shall be a nominal length such as 5, 10, or 20 ft. Any given laying length the purchaser specifies will constitute an assembled length. The allowable tolerance shall be  $\pm 1/2$  ,  $-1/8$  in. ( $\pm 13$ ,  $-3$  mm) on the components of the assembled laying length. The overall length of all flush threaded screen and casing shall be the nominal or specified laying length plus the length of the exposed male thread (pin).

NOTE 4—The purchaser should specify whether the length is to be the laying length or the overall length. The term “laying length” refers to the overall length less the length required to complete the assembly.

6.3 *Well Casing Pipe Couplings:*

6.3.1 *Socket Dimensions*—The socket dimensions of couplings shall conform to the requirements given in **Table 3** and **Table 4** when measured in accordance with Test Method **D2122**.

6.3.2 *Bell Socket Dimensions*—The socket dimensions of well casing pipe bell couplings shall be as shown in **Table 5** when measured in accordance with Test Method **D2122**.

6.3.3 *Bell Socket Wall Thickness*—The wall thickness of an integral bell shall be considered satisfactory if formed from pipe that meets the requirements of this specification.

6.3.4 *Laying Length Dimensions*—The laying length dimensions of well casing pipe couplings shall conform to the

requirements given in **Table 3**, **Table 4**, and **Table 5** when measured in accordance with Test Method **D2122**.

6.3.5 *Socket Concentricity or Alignment*— The maximum misalignment of axis of couplings with the pipe measured in the plane of the coupling face shall not exceed  $3/4$  in./20 ft (3 mm/1 m) of projected axis when measured in accordance with **7.4**.

6.4 *Pipe Stiffness and Flattening:*

6.4.1 *Well Casing Pipe*—The well casing pipe shall have a pipe stiffness at 5 % deflection equal to that shown in **Table 6** and **Table 7** and shall deflect 60 % of the original diameter (flattening) without cracking, rupture, or other visible evidence of failure when tested in accordance with Test Method **D2412**. Three specimens shall be tested and all shall pass.

NOTE 5—This test is intended for use as a quality control test, not as a simulated service test.

6.4.2 *Couplings and Bells* shall meet all the designated dimensional requirements of **Table 3**, **Table 4**, or **Table 5**. Molded couplings shall have a pipe stiffness at 5 % deflection equal to that shown in **Table 6** and **Table 7** and shall deflect 15 % without cracking, rupture, or other visible evidence of failure when tested in accordance with Test Method **D2412**. Three specimens shall be tested and all shall pass.

6.5 *Impact Resistance Classification*—The impact resistance classification (IC) value for well casing pipe shall be selected from **Table 8** by the manufacturer based on the measured average impact values determined in accordance with **7.5**.

6.6 *Tip Puncture Resistance*—The well casing pipe and well casing couplings shall deflect 30 % (puncture resistance) without cracking, rupture, or other visible evidence of failure when tested in accordance with **7.6** (**Note 7**). Three specimens shall be tested and all shall pass.

6.7 *Threads*—Well casing, screens, and couplings having threads shall have either American Standard ACME 2G screw threads, American Standard Stub ACME 2G screw threads, or Buttress screw threads, Class 2, or square form flush joint threads, in accordance with ANSI **B1.5** for ACME 2G screw threads, ANSI **B1.8** for Stub ACME 2G screw threads, and ANSI **B1.9** for Buttress screw threads. Examples of acceptable square form flush joint thread patterns for monitoring well construction are included in the annex.

6.7.1 All ACME, Stub ACME, and Buttress screw threads shall be gaged in accordance with **7.7**.

6.7.2 Machining flush joint square threads directly into the wall of the pipe may cause difficulty in measuring the thread dimensions when the pipe is removed from the threading device. The inherent out-of-round condition of the pipe will cause the thread dimensions to conform to the irregularities of the pipe. Measurements must be taken at many points and averaged. Alternatively gages of metal or other rigid material may be used when gage dimensions or methods are available.

6.7.3 *Thread Out-of-Roundness*—Out of roundness for threaded dimensions on Schedule 40 and Schedule 80 threads, described in the annex must conform to the “Out-of-Roundness Maximum Diameter Minus Minimum Diameter” figures found in **Table 1**.

**TABLE 1 Outside Diameters and Tolerance for Thermoplastic Well Casing Pipe, in.**

Nominal Pipe Size	Outside Diameter		Out-of-Roundness Maximum Diameter Minus Minimum Diameter		
	Average	Tolerance on Average	SDR41 SDR32.5 SDR26	SDR21 SDR17 SDR13.5	SCH40 and SCH80 <sup>4</sup>
2	2.375	$\pm 0.006$	0.060	0.024	0.024
2½	2.875	$\pm 0.007$	0.060	0.030	0.030
3	3.500	$\pm 0.008$	0.060	0.030	0.030
3½	4.000	$\pm 0.008$	0.100	0.030	0.030
4	4.500	$\pm 0.009$	0.100	0.030	0.030
5	5.563	$\pm 0.010$	0.100	0.060	0.060
6	6.625	$\pm 0.011$	0.100	0.070	0.070
8	8.625	$\pm 0.015$	0.150	0.090	0.090
10	10.750	$\pm 0.015$	0.150	0.100	0.100
12	12.750	$\pm 0.015$	0.150	0.120	0.120
14	14.000	$\pm 0.020$	0.150	0.150	0.150
15	15.300	$\pm 0.020$	0.150	0.150	
16	16.000	$\pm 0.020$	0.150	0.150	0.150

<sup>4</sup>Reference **D1527** for ABS and **D1785** for PVC.

**TABLE 2 Minimum Wall Thickness for Thermoplastic Well Casing Pipe, in.<sup>A</sup>**

Nominal Pipe Size	SDR41	SDR32.5	SDR26	SDR21	SDR17	SDR13.5	SCH40 <sup>B</sup>	SCH80 <sup>B</sup>
	Min	Min	Min	Min	Min	Min	Min	Min
2	..	..	..	0.113	0.140	0.176	0.154	0.218
2½	..	..	..	0.137	0.169	0.213	0.203	0.276
3	..	..	..	0.167	0.206	0.259	0.216	0.300
3½	..	..	..	0.190	0.235	0.296	0.226	0.318
4	0.110	0.138	0.173	0.214	0.265	0.333	0.237	0.337
5	0.136	0.171	0.214	0.265	0.327	0.412	0.258	0.375
6	0.162	0.204	0.255	0.316	0.390	0.491	0.280	0.432
8	0.210	0.265	0.332	0.410	0.508	..	0.322	0.500
10	0.262	0.331	0.413	0.511	0.632	..	0.365	0.593
12	0.311	0.392	0.490	0.606	0.750	..	0.406	0.687
14	0.342	0.430	0.539	0.667	..	..	0.437	0.750
15	0.373	0.471	..	..	..	..	..	..
16	0.390	0.493	0.616	0.762	..	..	0.500	0.843

<sup>A</sup>The minimum is the lowest wall thickness of the well casing pipe at any cross section.

<sup>B</sup>Reference: **D1527** for SCH40 and 80 ABS  
**D1785** for SCH40 and 80 PVC  
**D2241** for SDR PVC

**6.7.4 Thread Eccentricity**—The wall thickness eccentricity as well as the flush joint threads found in the annex shall be within 12 %.

**NOTE 6**—Ground water monitoring wells are usually constructed with flush joints to prevent bridging of materials placed in the well annulus during well installation. Interior surfaces are a flush finish to prevent equipment from becoming lodged at points where the inside diameter might constrict. Externally coupled pipe may be used, but the special needs of wells constructed for ground water monitoring, for example, no gravel or grout bridging, hollow stem auger inside diameter, solvent-free couplings, should be addressed.

**6.8 Threaded Joints**—Threaded joints including flush threaded joints made with well casing pipe and well casing couplings shall not leak. For ACME, Stub ACME, Buttress thread, and Flush Thread joints the test shall be an internal pressure of 25 psi (170 kPa) for 1 h in accordance with **7.8**.

**6.9 Joint Strength**—Joint tensile strength requirements will be added when test method and test results are available.

**6.10 Well Screens**—Screens manufactured from pipe or casing shall have uniform slots placed perpendicular to the long axis of the pipe. Slot width, length, interslot spacing, number of rows around the screen circumference and overall screen length shall comprise the product specification.

## 7. Test Methods

**7.1 Sampling**—A sample of the well casing pipe and coupling sufficient to determine conformance with this specification shall be taken at random from each lot in accordance with Section 9 of Practice **D1898**.

**7.2 Conditioning**—Unless otherwise specified, condition the specimens prior to test at 72.4 ± 3.6°F (23 ± 2°C) and 50 ± 5 % relative humidity for not less than 40 h in accordance with Procedure A of Practice **D618**. The manufacturer may use shorter conditioning time, but in case of disagreement Procedure A of Practice **D618** shall be used.

**7.3 Test Conditions**—Conduct tests in the standard laboratory atmosphere 73.4 ± 3.6°F (23 ± 2°C) and 50 ± 5 % relative humidity, unless otherwise specified in the test methods or in this specification.

**7.4 Socket Concentricity or Alignment** (see Practice **D2855**)—Select three bell socket couplings with sufficient pipe

so that concentricity and alignment tests for bell socket couplings may be made. Select three well casing pipe specimens, each specimen 12 ± ¼ in. (300 ± 3 mm) in length. Cut the ends square, free of burrs and jagged edges. Solvent cement the bell socket coupling and well casing pipe together following recommended procedures. Center the coupling onto a test mandrel that has been accurately centered on a lathe or lathe-type spindle. While the assembly is being rotated, eccentricity in the plane of the bell socket coupling face may be determined by means of a dial gage bearing radially against the bell socket coupling. The extent of the angular misalignment may be determined by means of a dial gage bearing radially against the well casing pipe approximately 1 ft (0.30 m) from the bell socket coupling face or a dial gage parallel to the axis against the bell socket coupling face. Other test methods may be used when agreed upon between the purchaser and the seller.

**7.5 Impact Classification** (see Test Methods **D2444**)—Determine the impact classification in accordance with Test Method **D2444**, using Tup B weighing 30 lb and Holder B. Select ten well casing pipe specimens of each size with each specimen 6 ± ¼ in. (150 ± 3 mm) in length. Condition the test specimens in a low-temperature environmental chamber maintaining a test temperature of 32 to 35.6°F a minimum of 2 h or in a mixture of ice and water at 32 to 35.6°F for 1 h before testing and test immediately on removal. Test ten specimens in accordance with Test Method **D2444**; nine of the ten specimens shall be above the lower limit of the IC cell. Examine the results for conformance with **6.5**.

### 7.6 Tup Puncture Resistance Test:

**7.6.1 Procedure**—Select three pipe specimens and three couplings. Determine whether the specimens are resistant to tup puncture at 30 % deflection by using the apparatus required for Test Method **D2412** and Tup A as defined in Test Method **D2444**. The test method uses a constant-load rate instead of an impact load. The Vee-block base has been enlarged to accommodate larger specimens as seen in **Fig. 1**. Machine the base so that the two sides of the Vee form an angle of 90 ± 0.01°. Mount Tup A of Test Method **D2444** on a square steel plate as shown in **Fig. 2**. Attach two Federal D01S dial gages to the

TABLE 3 Thermoplastic Water Well Casing Pipe Couplings Socket Dimensions and Laying Length Dimensions, in. (see Specification D2672)

NOTE 1—See 6.7 for thread dimensions other than ACME 2G screw threads.

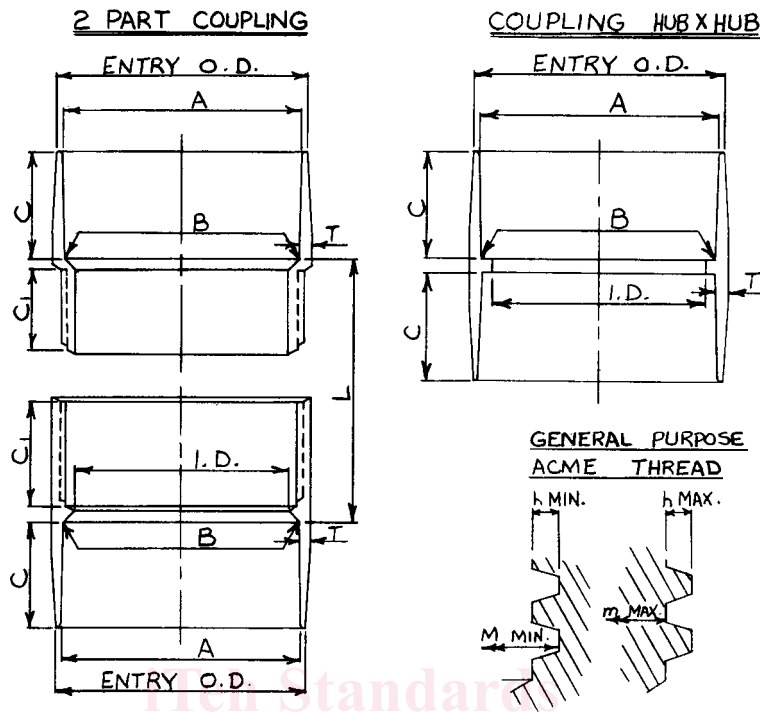

S	2	2½	3	3½	4	5	6	8	10	12
A	2.386	2.887	3.514	4.015	4.517	5.584	6.648	8.649	10.796	12.778
A <sub>1</sub>	±0.006	±0.007	±0.008	±0.008	±0.009	±0.010	±0.011	±0.015	±0.015	±0.015
B	2.370	2.869	3.493	3.992	4.491	5.553	6.614	8.613	12.737	12.736
B <sub>1</sub>	±0.006	±0.007	±0.008	±0.008	±0.009	±0.010	±0.011	±0.015	±0.015	±0.015
C	1.500	1.750	2.000	2.250	2.500	3.000	3.500	4.500	5.000	6.000
C <sub>1</sub>	1.000	1.250	1.500	1.750	2.000	2.500	3.000	4.000	4.500	5.500
ID	2.149	2.601	3.166	3.620	4.072	5.033	5.993	7.805	9.728	11.538
T	0.113	0.137	0.167	0.190	0.214	0.265	0.316	0.410	0.511	0.606
T <sub>1</sub>	+0.020	+0.020	+0.020	+0.023	+0.026	+0.032	+0.038	+0.049	+0.061	+0.073
h	0.083	0.100	0.100	0.125	0.125	0.166	0.200	0.250	0.333	0.375
M	2.465	2.982	3.606	4.131	4.630	5.735	6.830	8.878	11.086	13.127
m	2.289	2.772	3.396	3.871	4.370	5.393	6.420	8.368	10.410	12.367
L	1.500	1.750	2.000	2.250	2.500	3.000	3.500	4.500	5.000	6.000
OD	2.612	3.161	3.848	4.395	4.945	6.114	7.280	9.469	11.818	13.900

- S = nominal pipe size
- A = socket entrance diameter
- A<sub>1</sub> = tolerance on diameter
- B = socket bottom diameter
- B<sub>1</sub> = tolerance on diameter
- C = socket depth
- C<sub>1</sub> = thread length
- ID = bore diameter
- T = minimum wall thickness
- T<sub>1</sub> = tolerance on wall thickness
- h = thread height—for ACME 2G screw thread (Note)
- M = major diameter of internal thread—for ACME 2G screw thread (Note)
- m = minor diameter of external thread—for ACME 2G screw thread (Note)
- L = lay length
- OD = outside diameter at entry of hub

square steel plate 180° apart as seen in Fig. 3 and Fig. 4. Measure the specimens to determine the point of minimum wall thickness. Place the pipe or coupling specimen of 6 ± 1/8 in. (150 ± 3 mm) in length in the universal load machine with the minimum wall of the specimen positioned directly under the nose of the tup. Place spacers between the dial gage stems

and the base so that the deflection of the tup versus load can be measured. The speed of testing shall be 0.5 ± 0.02 in. (12.5 ± 0.5 mm)/min. Continue the test until the diameter is deflected 30 % of its original diameter (puncture resistance). Examine the test results for each specimen of pipe and coupling for conformance to Section 6.

TABLE 4 Metric Equivalents for Table 3, mm

S	2	2½	3	3½	4	5	6	8	10	12½
A	60.60	73.32	89.26	101.98	114.74	141.84	168.86	219.68	273.71	324.56
A <sub>1</sub>	±0.16	±0.18	±0.20	±0.20	±0.22	±0.26	±0.28	±0.38	±0.38	±0.38
B	60.20	72.88	88.72	101.40	114.08	141.04	168.00	218.78	272.72	323.50
B <sub>1</sub>	±0.16	±0.18	±0.20	±0.20	±0.22	±0.26	±0.28	±0.38	±0.38	±0.38
C	38	44	51	57	64	76	89	114	127	152
C <sub>1</sub>	25	32	38	44	51	64	76	102	114	140
ID	54.58	66.06	80.42	91.94	103.42	127.84	152.22	198.24	247.10	293.06
T	2.88	3.48	4.24	4.82	5.44	6.74	8.02	10.42	12.98	15.40
T <sub>1</sub>	+0.50	+0.50	+0.50	+0.58	+0.66	+0.82	+0.96	+1.24	+1.54	+1.86
h	2.10	2.54	2.54	3.18	3.18	4.22	5.08	6.34	8.46	9.52
M	62.62	75.74	91.60	104.92	117.60	145.66	173.48	225.50	281.58	333.42
m	58.14	70.40	86.26	98.32	111.00	136.98	163.06	212.54	264.40	314.12
L	38	44	51	57	64	76	89	114	127	152
OD	66.34	80.28	97.74	111.64	125.60	155.30	184.92	240.52	300.18	355.34

TABLE 5 Tapered Sockets for Bell-End Pipe, in.<sup>4</sup>

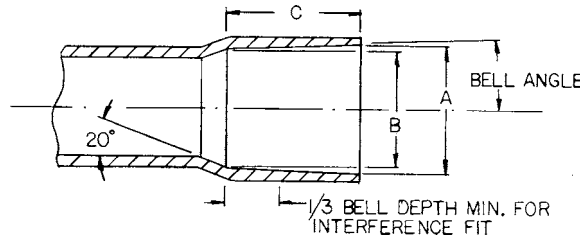

Nominal Pipe Size	A Socket Entrance Diameter			B Socket Bottom Diameter			C Socket Length, min
	Diameter	Tolerance on Diameter	Max Out-of-Round	Diameter	Tolerance on Diameter	Max Out-of-Round	
2	2.386	±0.006	±0.012	2.363	±0.006	±0.012	3.000
2½	2.887	±0.007	±0.015	2.861	±0.007	±0.015	3.500
3	3.514	±0.008	±0.015	3.484	±0.008	±0.015	4.000
3½	4.015	±0.008	±0.015	3.984	±0.008	±0.015	4.500
4	4.517	±0.009	±0.015	4.482	±0.009	±0.015	5.000
4½	4.968	±0.009	±0.030	4.932	±0.009	±0.030	5.500
5	5.584	±0.010	±0.030	5.543	±0.010	±0.030	6.000
6	6.648	±0.011	±0.030	6.603	±0.011	±0.030	6.500
6¼	6.922	±0.011	±0.030	6.878	±0.011	±0.030	7.000
8	8.649	±0.015	±0.045	8.598	±0.015	±0.045	7.000
10	10.776	±0.015	±0.050	10.722	±0.015	±0.050	7.500
12	12.778	±0.015	±0.060	12.721	±0.015	±0.060	8.000
14	14.035	±0.015	±0.060	13.970	±0.015	±0.060	8.000
16	16.045	±0.015	±0.060	15.970	±0.015	±0.060	8.000

<sup>4</sup>Minimum dimensions have zero negative tolerance. The sketches and designs of fittings are illustrative only.

TABLE 6 Minimum Pipe Stiffness at 5 % Deflection, lbf/(in.-in.) (kN/(m-m))

NOTE 1—The PS values are computed on the basis of minimum pipe wall thickness with the following material moduli: SR, 300 000 psi (2.07 GPa); ABS, 250 000 and 350 000 psi (1.72 to 2.41 GPa); and PVC, 400 000 psi (2.76 GPa).

	SDR 13.5	SDR 17	SDR 21	SDR 26	SDR 32.5	SDR 41
SR	684 (4720)	339 (2340)	168 (1160)	84 (580)	...	...
ABS 250 000	570 (3935)	273 (1942)	140 (964)	70 (485)	...	...
ABS 350 000	798 (5510)	395 (2720)	196 (1350)	98 (677)	...	...
PVC	912 (6290)	452 (3120)	224 (1550)	112 (774)	56	28

NOTE 7—The tup puncture test for point load is derived from Test Methods D2412 and D2444, combined to achieve a meaningful design parameter for well casing pipe used in water well construction. There are many possibilities for a point load to be exerted on the well casing pipe. Perhaps the most significant of these is the stringing of a well casing pipe through a boulder field. The sides of the well hole are seldom smooth surfaces, but rather pieces of rock are embedded in the surrounding soil layers. When these rock particles come in contact with the well casing pipe, a point loading situation can develop. Natural earth movements can

impose high stresses over a small area of well casing pipe surface. This type of localized load is an entirely different situation from a uniform load.

7.7 Threads—Gage the threads using gages specified in accordance with recommended gages and gaging practice for external and internal threads as specified in the following standards:

ANSI B1.5 1973

**TABLE 7 Minimum Pipe Stiffness for SCH 40 and SCH 80 Well Casing Pipe, PSI (kN/(m<sup>2</sup>))<sup>A</sup>**

Nominal Pipe Size, in.	SCH40	SCH80	SCH40	SCH80	SCH40	SCH80
	ABS 250 000	ABS 250 000	ABS 350 000	ABS 350 000	PVC	PVC
2	373 (2571)	1155 (7963)	543 (3743)	1680 (11582)	600 (4136)	1920 (13236)
2½	490 (3378)	1340 (9238)	630 (4343)	1960 (13512)	800 (5515)	2240 (15443)
3	318 (2192)	921 (6349)	464 (3199)	1330 (9169)	510 (3516)	1520 (10479)
3½	240 (1655)	720 (4964)	350 (2413)	1033 (7122)	400 (2758)	1180 (8135)
4	192 (1324)	593 (4088)	284 (1958)	823 (5674)	310 (2137)	940 (6480)
5	128 (882)	422 (2909)	182 (1255)	613 (4226)	208 (1434)	702 (4840)
6	96 (662)	329 (2268)	137 (944)	553 (3812)	150 (1034)	632 (4357)
8	65 (448)	260 (1792)	91 (627)	378 (2606)	100 (689)	432 (2978)
10	48 (331)	222 (1530)	68 (469)	326 (2247)	78 (538)	372 (2565)
12	49 (338)	206 (1420)	58 (400)	301 (2075)	63 (434)	344 (2372)
14	...	...	...	...	59 (407)	336 (2316)
16	...	...	...	...	59 (407)	324 (2234)

<sup>A</sup>Reference **D1527** for ABS and **D1785** for PVC.

**TABLE 8 Impact Classification (IC) Cell Classification (see Test Methods **D2444**)**

Nominal Pipe Size, in.	IC-0	IC-1, m·kg(ft·lb)	IC-2, m·kg(ft·lb)	IC-3, min, m·kg(ft·lb)
2	Ns <sup>A</sup>	9.7–12.4(70–90)	12.4–15.2(90–110)	>15.2(110)
2½	Ns	11.0–13.8(80–100)	13.8–18.0(100–130)	>18.0(130)
3	Ns	16.6–19.4(120–140)	19.4–24.9(140–180)	>24.9(180)
3½ †	Ns	18.0–22.1(130–160)	22.1–27.7(160–200)	>27.7(200)
4	Ns	22.1–27.7(160–200)	27.7–33.2(200–240)	>33.2(240)
5	Ns	24.9–30.4(180–220)	30.4–36.0(220–260)	>36.0(260)
6	Ns	27.7–36.0(200–260)	36.0–41.5(260–300)	>41.5(300)
8	Ns	36.0–41.5(260–300)	>41.5(300)	>41.5(300)
10	Ns	>41.5(300)	>41.5(300)	>41.5(300)
12, 14, 16	Ns	>41.5(300)	>41.5(300)	>41.5(300)

<sup>A</sup>Ns—Not specified.

† Value was corrected May 2006.

ANSI **B1.8** 1973

ANSI **B1.9** 1973

(Not Flush Threaded)

Screw-Threads, Standards for Federal Service 1957 Part III, Handbook H28

7.7.1 Machining flush joint threads directly into the wall of the pipe may cause difficulty in measuring the thread dimensions when the pipe is removed from the threading device. The inherent out-of-round condition of the pipe will cause the thread dimensions to conform to the irregularities of the pipe. Measurements must be taken at many points and averaged. Alternatively gages of metal or other rigid material may be used when gage dimensions or methods are available. Gages should be polished and free of all lubricants when used. The male gage should be fitted with an “O” ring of the same material, durometer, and dimensions as that specified for the manufactured product.

7.8 *Threaded Joints*—Assemble two specimens of well casing pipe, 6 ± ⅛ in. (150 ± 3 mm), together with a male and female two-piece threaded well casing pipe coupling. Solvent cement the male and female well casing pipe coupling to each specimen of well casing pipe and allow to stand for 24 h at room temperature. Apply an approved thread lubricant, specifically intended for use with the designated plastic material, to the threads of the male and female two-piece well casing pipe coupling and assemble. Subject the specimen to an internal pressure of 25 psi (170 kPa) with water as a medium, for 1 h. Should the threads be an integral part of the casing, the assembling of the coupling to the pipe shall be omitted. Examine the well casing pipe coupling joint for leakage to determine conformance to the requirements of **6.8**.

7.8.1 *Flush Threaded Joints*—Assemble the specimens of well casing, one threaded female and one threaded male with an “O” ring. No adhesives, solvents, or sealants may be used. Water only may be used, if necessary, to ensure a smooth closure. The joint should then be torqued to the maximum value to be specified for that joint pattern. Allow the joint to stand for 24 h at room temperature. Subject the specimen to an internal pressure of 25 psi (170 kPa) with water as a medium, for 1 h. Examine the well casing pipe joint for leakage to determine conformance to the requirements of **6.8**.

## 8. Retest and Rejection

8.1 If the results of any test(s) do not meet the requirements of this specification, the test(s) may be conducted again in accordance with an agreement between the purchaser and the seller. In retesting, the product requirements of this specification shall be met, and the test methods designated in the specification shall be followed. If, upon retest, failure occurs, the quantity of product represented by the test(s) does not meet the requirements of this specification.

## 9. Product Marking

9.1 *Quality of Product Marking*—The product marking shall be applied to the pipe in such a manner that it remains legible (easily read) after installation and inspection.

9.2 *Content of Product Marking*:

9.2.1 *Well Casing Pipe*—The well casing pipe shall be marked at least every 5 ft (1.5 m) in letters not less than ⅜ in. (5 mm) high in a contrasting color with the following information:

9.2.1.1 Nominal well casing pipe size (for example, 2 in.),

1" x 12" x 18" 2- REQUIRED 122.4 LBS.  
 3/4" x 16" x 20" 1- REQUIRED 68.0 LBS.  
 3/4" TRAPEZOID SECTION 6-REQ'D. 57.4 LBS.

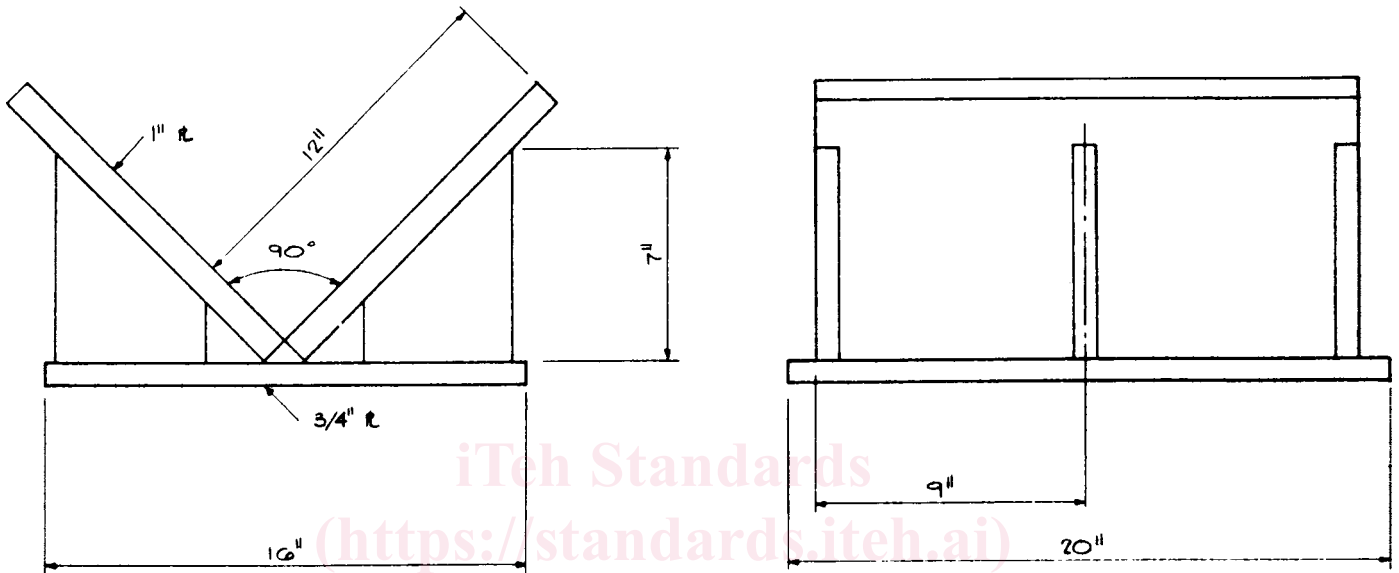
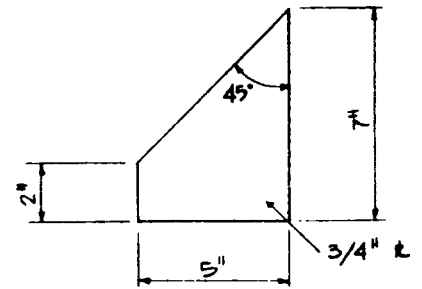

FIG. 1 V-Block Support (No Scale)  
 Configuration of Top A Impact Resistance of Thermoplastic Pipe (Test Method D2444)

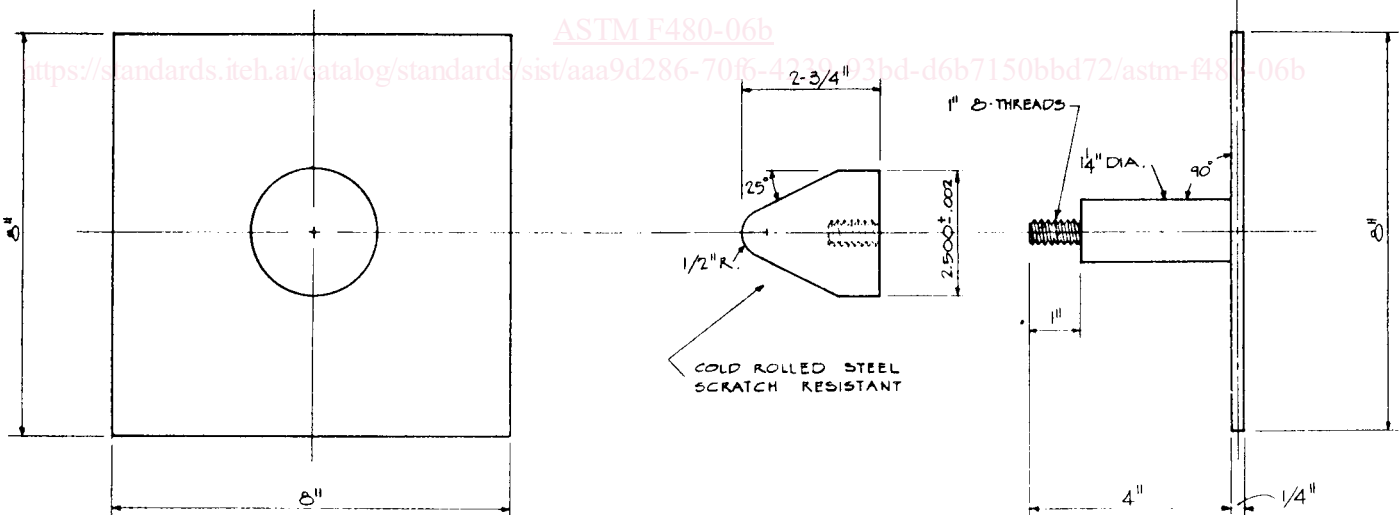

FIG. 2 Tup Test Apparatus (No Scale)

9.2.1.2 Well casing pipe standard dimension ratio, in accordance with designation code given in 3.2 (for example, SDR 17),

9.2.1.3 Type of plastic well casing pipe material (for example, ABS250, ABS350, PVC, or SR),

9.2.1.4 The wording—well casing—followed by the impact classification (for example, IC-3),

9.2.1.5 Designation ASTM F480, with which the well casing pipe complies,

9.2.1.6 Manufacturer's name (or trademark), and

9.2.1.7 Manufacturer's code for resin manufacture, lot number, and date of manufacture.

9.2.1.8 Well casing pipe intended for potable water shall also include the seal or mark of the laboratory making the



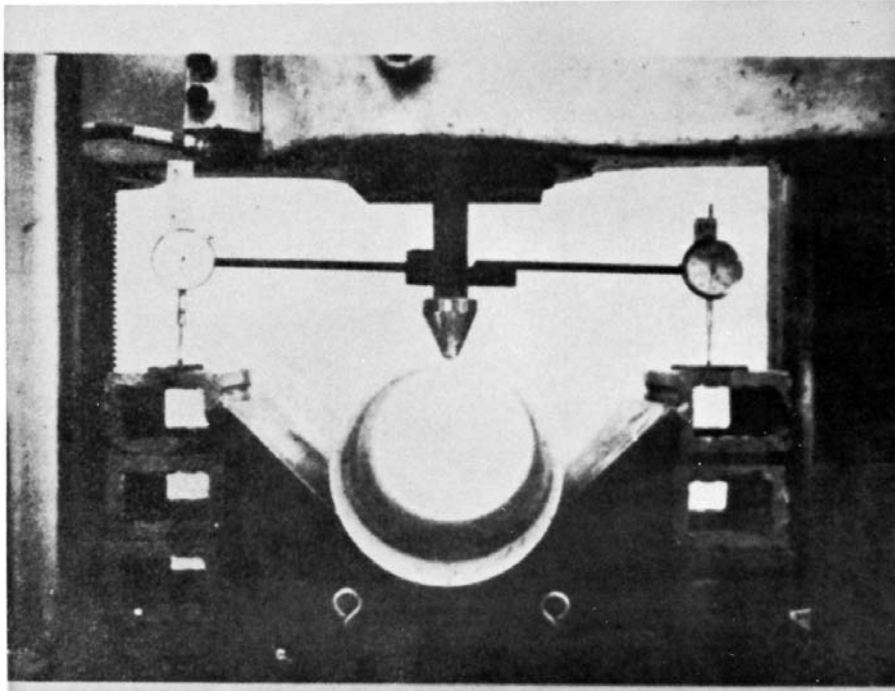

FIG. 3 Tup Test Apparatus

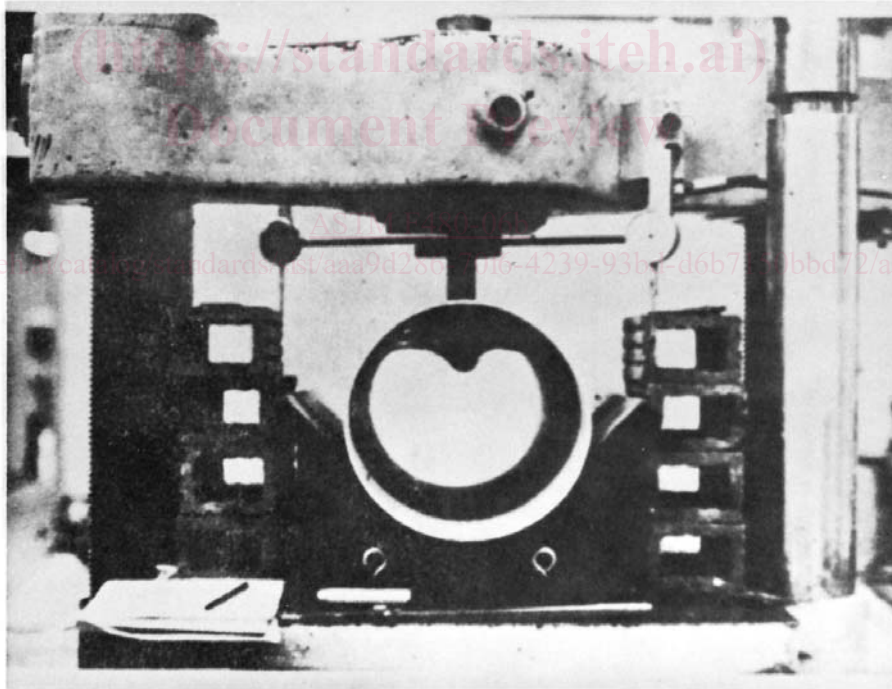

FIG. 4 Example of Specimen During Tup Test

evaluation for this purpose spaced at intervals specified by the laboratory (see Supplementary Requirements S3).

9.2.1.9 Well casing pipe intended for manufacture into screen or casing for ground water monitoring use shall not be marked with any foreign material, for example, ink, unless it can be independently proven that the marking material will not

contaminate the ground water sample or affect the subsequent analysis of the water sample for pollutants.

9.3 *Well Casing Pipe Coupling*—Well casing pipe couplings shall be marked in letters not less than  $\frac{3}{16}$  in. (5 mm) high, with the following information:

9.3.1 Nominal well casing pipe coupling size (for example, 2 in.),

9.3.2 Type of plastic well casing pipe coupling material (for example, ABS250, ABS350, PVC, or SR),

9.3.3 ASTM Designation F480, with which the well casing pipe coupling complies, and

9.3.4 Manufacturer's name (or trademark).

9.3.5 Well casing pipe couplings intended for potable water shall also include the seal or mark of the laboratory making the evaluation for this purpose spaced at intervals specified by the laboratory (see Supplementary Requirements S3).

## 10. Quality Assurance

10.1 When the product is marked with this designation, F480, the manufacturer affirms that the product was manufactured, inspected, sampled, and tested in accordance with this specification and has been found to meet the requirements of this specification.

## 11. Keywords

11.1 couplings; flush thread; ground water; poly(vinyl chloride); PVC; thermoplastic; well-casing; well screen

## SUPPLEMENTARY REQUIREMENTS

### GOVERNMENT/MILITARY PROCUREMENT

These requirements apply *only* to federal/military procurement, not domestic sales or transfers.

S1. *Responsibility for Inspection*—Unless otherwise specified in the contract or purchase order, the producer is responsible for the performance of all inspection and test requirements specified herein. The producer may use his own or any other suitable facilities for the performance of the inspection and test requirements specified herein, unless the purchaser disapproves. The purchaser shall have the right to perform any of the inspections and tests set forth in this specification where such inspections are deemed necessary to ensure that material conforms to prescribed requirements.

NOTE S1-1—In U.S. federal contracts, the contractor is responsible for inspection.

S2. *Packaging and Marking for U.S. Government Procurement*:

S2.1 *Packaging*—Unless otherwise specified in the contract, the material shall be packaged in accordance with the supplier's standard practice in a manner ensuring arrival at destination in satisfactory condition and which will be acceptable to the carrier at lowest rates. Containers and packing shall comply with Uniform Freight Classification rules or National Motor Freight Classification rules.

S2.2 *Marking*—Marking for shipment shall be in accordance with **FED-STD-123** for civil agencies and **MIL-STD-129** for military agencies.

NOTE S2-1—The inclusion of U.S. Government procurement requirements shall not be construed as an indication that the U.S. Government uses or endorses the products described in this specification.

[ASTM F480-06b](https://standards.iteh.ai/catalog/standards/sist/aaa9d286-70f5-4239-93bd-d6b7150bbd72/astm-f480-06b)

<https://standards.iteh.ai/catalog/standards/sist/aaa9d286-70f5-4239-93bd-d6b7150bbd72/astm-f480-06b>

### POTABLE WATER REQUIREMENT

This requirement applies whenever a Regulatory Authority or user calls for product to be used to convey or to be in contact with potable water.

S3. *Potable Water Requirement*—Products intended for contact with potable water shall be evaluated, tested and certified for conformance with ANSI/**NSF 61** or the health

effects portion of **NSF 14** by an acceptable certifying organization when required by the regulatory authority having jurisdiction.