



Designation: E1065 – 08

Standard Guide for Evaluating Characteristics of Ultrasonic Search Units¹

This standard is issued under the fixed designation E1065; the number immediately following the designation indicates the year of original adoption or, in the case of revision, the year of last revision. A number in parentheses indicates the year of last reappraisal. A superscript epsilon (ϵ) indicates an editorial change since the last revision or reappraisal.

1. Scope

1.1 This guide covers measurement procedures for evaluating certain characteristics of ultrasonic search units (also known as “transducers”) that are used with ultrasonic examination instrumentation. This guide describes means for obtaining performance data that may be used to define the acoustic and electric responses of ultrasonic search units.

1.2 The procedures are designed to measure search units as individual components (separate from the ultrasonic test instrument) using commercial search unit characterization systems or using laboratory instruments such as signal generators, pulsers, amplifiers, oscilloscopes, and waveform analyzers.

1.3 The procedures are applicable to manufacturing acceptance and incoming inspection of new search units or to periodic performance evaluation of search units throughout their service life.

1.4 The procedures in [Annex A1-Annex A6](#) are generally applicable to ultrasonic search units operating within the 0.4 to 10 MHz range. [Annex A7](#) is applicable to higher frequency immersion search unit evaluation. Annex A8 describes a guide for measuring sound beam profiles in metals from contact straight-beam search units. Additional Annexes, such as sound beam profiling for angle-beam search units in metal and alternate means for search unit characterization, will be added when developed.

1.5 The values stated in inch-pound units are to be regarded as standard.

1.6 *This standard does not purport to address all of the safety concerns, if any, associated with its use. It is the responsibility of the user of this standard to establish appropriate safety and health practices and determine the applicability of regulatory limitations prior to use.*

¹ This guide is under the jurisdiction of ASTM Committee E07 on Nondestructive Testing and is the direct responsibility of Subcommittee E07.06 on Ultrasonic Method.

Current edition approved July 1, 2008. Published July 2008. Originally approved in 1985. Last previous edition approved in 2003 as E1065 – 99(2003). DOI: 10.1520/E1065-08.

2. Referenced Documents

2.1 *ASTM Standards*:²

E1316 [Terminology for Nondestructive Examinations](#)

2.2 *Other Document*:

[Standard Methods for Testing Single Element Pulse-Echo Ultrasonic Transducers](#)³

3. Terminology

3.1 *Definitions*—For definitions of terms used in this guide, see Terminology E1316.

3.2 *Definitions of Terms Specific to This Standard*:

3.2.1 *aperture*—the dimension(s) of the active area of the piezoelectric element of the search unit as established by experimentation.

3.2.2 *bandwidth (BW)*—that portion of the frequency response that falls within given limits. In this text, the limits used are the -6 dB level, as measured from the peak of the frequency response. The equation used for *BW* is:

$$BW = (f_u - f_l)/f_c \times 100 \quad (1)$$

where:

f_u = upper frequency,

f_l = lower frequency, and

f_c = center frequency.

Bandwidth is expressed as a percentage.

3.2.3 *center frequency (f_c)*—the frequency value calculated to be at the center of the bandwidth limits.

3.2.4 *depth of field (F_D)*—as measured on the on-axis profile of a focused search unit, that portion of the sound beam that falls within given limits.

3.2.5 *focal length (F_L)*—for focused search units, the distance from the lens to the focal point.

² For referenced ASTM standards, visit the ASTM website, www.astm.org, or contact ASTM Customer Service at service@astm.org. For *Annual Book of ASTM Standards* volume information, refer to the standard’s Document Summary page on the ASTM website.

³ Available from the American Institute of Ultrasonics in Medicine, 14750 Sweitzer Lane, Suite 100, Laurel, MD 20707-5906.

3.2.6 *focal point* (F_p)—for focused search units, the point along the acoustic axis of the beam in water at which the peak (maximum) pulse-echo amplitude response is recorded from a ball target reflector.

3.2.7 *frequency response*—the pulse-echo response of the search unit measured as a function of frequency. (This term also referred to as frequency spectrum.)

3.2.8 *nominal frequency* (f_{nom})—the frequency stated on the label supplied by the manufacturer.

3.2.9 *on-axis profile*—a sequence of measurements made along the acoustic axis of the beam of the search unit.

3.2.10 *peak frequency* (f_p)—the frequency value at the maximum amplitude of the frequency response.

3.2.11 *pulse duration*—the length of the sinusoidal burst used to excite the search unit as expressed in time or number of cycles (sometimes referred to as tone-burst).

3.2.12 *pulse echo sensitivity*—a measurement that compares the amplitude of the applied voltage with the amplitude of the pulse-echo voltage recorded from a specified target.

3.2.13 *shock excitation*—a short electrical impulse that is applied to the search unit. The impulse is typically a negative-going voltage spike of fast rise time and short duration.

3.2.14 *transverse profile*—sequence of measurements made along a line perpendicular to the acoustic axis of the beam of the search unit.

3.2.15 *waveform duration*—the time interval or duration over which the unrectified signal or echo from a specified target exceeds a selected amplitude level as related to the maximum amplitude of the signal or echo (for example, -20 or -40 dB).

4. Summary of Guide

4.1 The acoustic and electrical characteristics which can be described from the data obtained by procedures outlined in this guide are described as follows:

4.1.1 *Frequency Response*—The frequency response may be obtained from one of two procedures: (a) shock excitation and (b) sinusoidal burst. **Annex A1** describes procedures for obtaining frequency response for immersion and zero-degree contact search units. **Annex A2** describes the procedure for obtaining bandwidth characteristics.

4.1.2 *Relative Pulse-Echo Sensitivity* (S_{rel})—The relative pulse-echo sensitivity may be obtained from the frequency response data obtained using the sinusoidal burst procedure described in **Annex A1**. The value is obtained from the relationship of the amplitude of the voltage applied to the search unit and the amplitude of the pulse-echo signal received from a specified target. **Annex A3** describes the procedure for obtaining pulse-echo sensitivity.

NOTE 1—Values for applied and received power, from which insertion loss might be determined are not covered with procedures described in this guide.

4.1.3 *Time Response*—The time response provides a means for describing the radio frequency (rf) response of the waveform. A shock excitation, pulse-echo procedure is used to obtain the response. The time or waveform responses are

recorded from specific targets that are chosen for the type of search unit under evaluation (for example, immersion, contact straight beam, or contact angle beam). **Annex A4** describes the procedures for measuring time response.

4.1.4 *Electrical Impedance*:

4.1.4.1 *Complex Electrical Impedance*—The complex electrical impedance may be obtained with commercial impedance measuring instrumentation, and these measurements may be used to provide the magnitude and phase of the impedance of the search unit over the operating frequency range of the unit. These measurements are generally made under laboratory conditions with minimum cable lengths or external accessories and in accordance with the instructions of the instrument manufacturer. The value of the magnitude of the complex electrical impedance may also be obtained using values recorded from the sinusoidal burst techniques as outlined in **Annex A5**.

4.1.4.2 *d-c Resistance*—The d-c resistance of the search unit may provide information regarding the electrical tuning elements. Measurements are made across the terminals of the unit.

4.1.5 *Sound Field Measurements*—The objective of these measurements is to establish parameters such as the on-axis and transverse sound beam profiles for immersion flat and focused search units.

4.1.5.1 **Annexes A6 and A8** of this guide describe ways for making sound field measurements for both immersion flat and focused search units in water and contact straight-beam search units in metal. The literature discusses several ways for making these measurements, but the techniques described are relatively simple and easily performed.

4.1.5.2 Means are recommended for making measurements in an immersion tank, thereby allowing either pulse-echo (ball target) or hydrophone receiver techniques to be followed. The goal is to provide measurements to evaluate the characteristics of search units or to identify changes that may occur as a function of time or use, or both.

4.1.5.3 None of the measurements of sound beam patterns are intended to define limits of performance. They are designed to provide a common means for making measurements that may be used to define the initial and inservice performance.

NOTE 2—No procedure is given for measuring sound beam profile characteristics for angle-beam search units. Several potential approaches are being considered, but have not yet gained subcommittee agreement(1),⁴

NOTE 3—*Frequency Response Displays*. The frequency responses in **Fig. 1** and **Fig. 2** and throughout the text are displayed as a linear amplitude (not logarithmic) response as a function of frequency. The recording or line drawing shows only the positive component or envelope of the responses. While this is the normal display for a spectrum analyzer, the sinusoidal burst response is shown as only one-half of the actual sinusoidal wave.

5. Significance and Use

5.1 This guide is intended to provide standardized procedures for evaluating ultrasonic search units. It is not intended to define performance and acceptance criteria, but rather to provide data from which such criteria may be established.

⁴ The boldface numbers in parentheses refer to a list of references at the end of this test method.

Shock Excitation —
Frequency and Time Responses

User May Add Other Data About Search Unit, e.g. MFG, Style Type, Serial No., Cable Target etc.

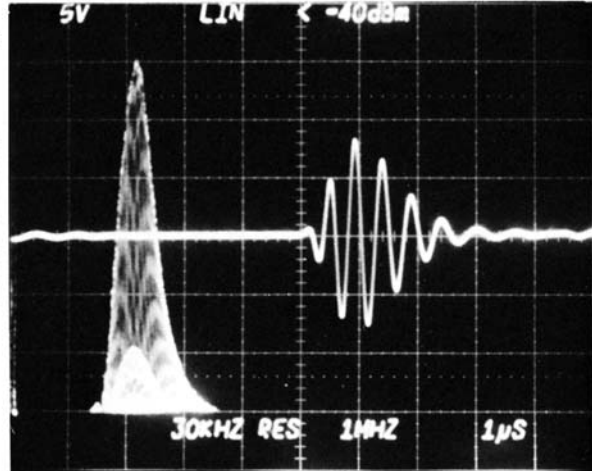

Peak Frequency ----- f_p	2.2 MHz	Bandwidth --- BW	32%
Center Frequency ----- f_c	2.15 MHz	Waveform Duration:	
Upper Frequency @ -6dB f_u	2.5 MHz	@ -20dB level	3 μ sec
Lower Frequency @ -6dB f_l	1.8 MHz	@ -40dB level	3.7 μ sec

FIG. 1 Test Data Available from Shock Excitation Procedure

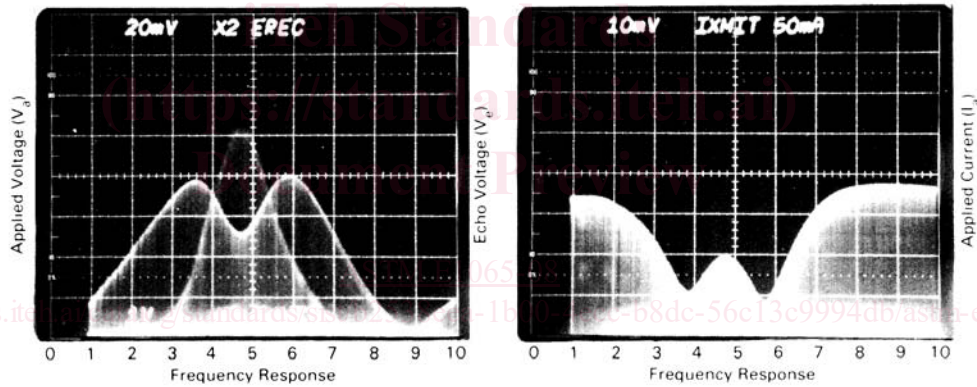

User May Add Other Data About Search Unit e.g. MFG, Style, Type, Serial No. Cable, Target etc.

Peak Frequency ----- f_p	4.7 MHz	Bandwidth ----- BW	43%
Center Frequency ----- f_c	4.7 MHz	Relative Sensitivity -- Srel	-27dB
Upper Frequency @ -6dB f_u	5.7 MHz	Electrical Impedance (mag)	52 Ω
Lower Frequency @ -6dB f_l	3.7 MHz		

FIG. 2 Test Data Available from Sinusoidal Burst Technique

5.2 These procedures are intended to evaluate the characteristics of single-element piezoelectric search units.

5.3 Implementation may require more detailed procedural instructions in a format of the using facility.

5.4 The measurement data obtained may be employed by users of this guide to specify, describe, or provide a performance criteria for procurement and quality assurance, or

service evaluation of the operating characteristics of ultrasonic search units. All or portions of the guide may be used as determined by the user.

5.5 The measurements are made primarily under pulse-echo conditions. To determine the relative performance of a search unit as either a transmitter or a receiver may require additional tests.

5.6 While these procedures relate to many of the significant parameters, others that may be important in specific applications may not be treated. These might include power handling capability, breakdown voltage, wear properties of contact units, radio-frequency interference, and the like.

5.7 Care must be taken to ensure that comparable measurements are made and that users of the guide follow similar procedures. The conditions specified or selected (if optional) may affect the test results and lead to apparent differences.

5.8 Interpretation of some test results, such as the shape of the frequency response curve, may be subjective. Small irregularities may be significant. Interpretation of the test results is beyond the scope of this guide.

5.9 Certain results obtained using the procedures outlined may differ from measurements made with ultrasonic test instruments. These differences may be attributed to differences in the nature of the experiment or the electrical characteristics of the instrumentation.

5.10 The pulse generator used to obtain the frequency response and time response of the search unit must have a rise time, duration, and spectral content sufficient to excite the

search unit over its full bandwidth, otherwise time distortion and erroneous results may result.

6. Typical Results Obtainable from Tests Described in Annex A1-Annex A5

6.1 Fig. 1 illustrates some of the typical results that may be obtained using shock excitation techniques. Values for frequency response, peak frequency, bandwidth, bandwidth center frequency, and time response may be obtained.

6.2 Fig. 2 illustrates the typical results obtained using the sinusoidal burst technique. Values may be obtained for frequency response, peak frequency, bandwidth, bandwidth center frequency, relative pulse-echo sensitivity, and magnitude of the electrical impedance from the data recorded with this technique.

7. Keywords

7.1 aperture; bandwidth; characterization; contact testing; depth of field; focal point; frequency response; immersion testing; peak frequency; search unit; sound beam profile; time response; ultrasound

ANNEXES

(Mandatory Information)

A1. MEASUREMENT OF FREQUENCY RESPONSE

A1.1 *Introduction*—The frequency response (also known as frequency spectrum) is a measure of the amplitude of the pulse-echo response from a given target as a function of frequency. This response is used as the basis for establishing other operating parameters of the search unit including peak frequency, center frequency (see Annex A1), bandwidth (see Annex A2) and sensitivity (see Annex A3). Sketches of typical response curves are shown in Fig. A1.1. These sketches are used to describe two conditions: (a) a response that is symmetrical about a center frequency, and (b) a condition in which the frequency response is asymmetrical.

A1.1.1 Two means are described for obtaining the frequency response: (a) shock excitation, and (b) sinusoidal burst. The responses obtained using these procedures provide similar results; however, reproducibility is dependent on factors such as generator driving impedance, search unit impedance, pulse shape, and measurement systems. The measurement system to be used for search unit evaluation should be established by users of the guide.

A1.2 *Shock Excitation Technique*—The shock excitation technique for obtaining frequency response is based on the principle that a shock pulse applied to the search unit produces a broad spectrum of energies and that the echo from a given target reflects the frequency distribution that is characteristic of that search unit. Measurements may be made using either the analog or digitized rf waveform. Fig. A1.2 describes typical

components used to measure frequency response of an rf analog waveform. The system consists of a search unit, shock pulse generator (pulser), preamplifier (receiver), electronic gate that can be adjusted to capture the echo waveform, display oscilloscope, and spectrum analyzer. Fig. A1.3 describes typical components used to measure the frequency response of a digitized rf waveform. The system consists of a search unit, pulser, receiver, gate that can be adjusted to capture the echo waveform, analog to digital converter (digitizer), Fourier transform calculator, and display. To make the measurement, an excitation pulse is applied to the search unit and an echo is obtained from a specific target. The gated echo is monitored on an oscilloscope to ensure that only the desired rf waveform is analyzed. The gated analog rf waveform is input to the spectrum analyzer, (see Fig. A1.2). The gated digitized waveform is input to the Fourier transform calculator and displayed, (see Fig. A1.3). The resultant spectrum describes the frequency response of the search unit.

NOTE A1.1—*Special Notice for Frequency Response Measurements.* With correct settings, the results from the shock excitation and sinusoidal burst procedures will produce similar results. However, because of the multiple variables associated with electronic components and adjustments, some differences may result. Users of the guide must identify the parameters that will be used to make the measurements.

NOTE A1.2—Pulser generators used for shock excitation of search units are designed to have low driving or *on* impedances and high *off* impedances. Generally, the duration of the pulse can be adjusted to provide a maximum energy transfer to a search unit. As the pulse duration and the output impedance of the generator may influence the actual

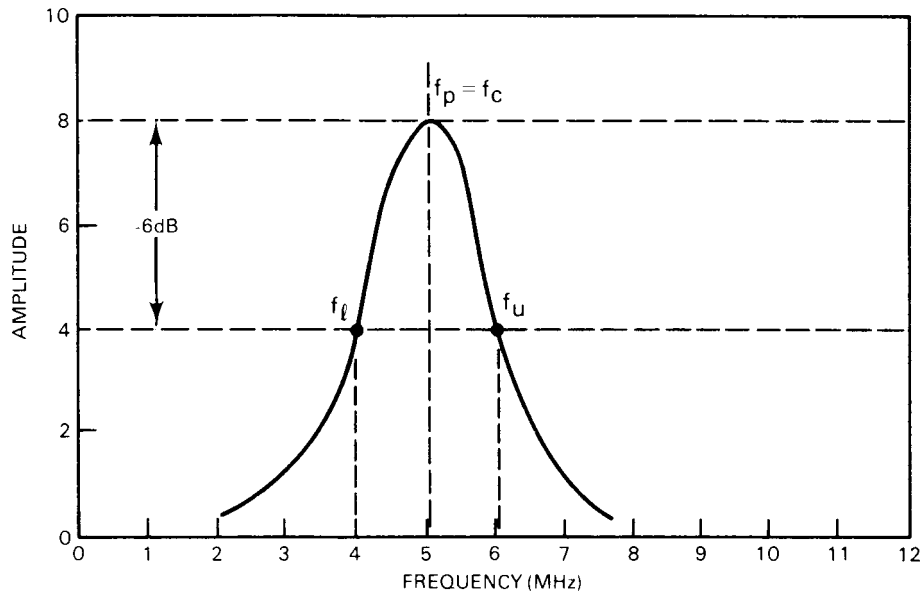

(a) Symmetrical-Response Curve

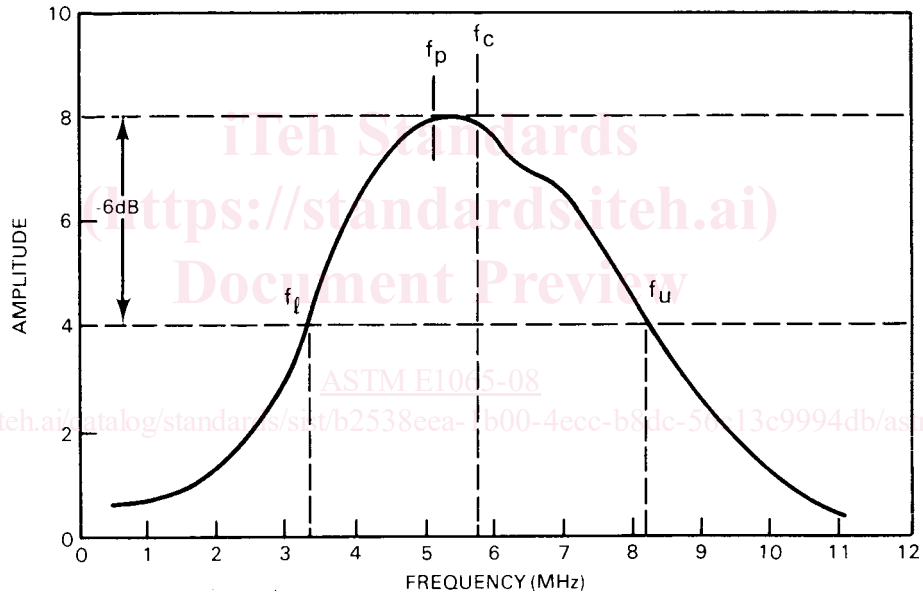

(b) Asymmetrical-Response Curve

FIG. A1.1 Frequency-Response Curves

spectrum delivered to the search unit, care must be exercised to ensure that the spectrum of energies applied is sufficient to accurately describe the frequency response of the search unit. Operating parameters of the pulser should be established by users of the guide. The electrical impedance of the receiver used can have an influence on the frequency response. The input impedance of the receiver should be high (500 ohms or higher) to reduce the potential adverse influence.

NOTE A1.3—For measurement of frequency response, a digitizer capable of providing a minimum of ten samples per cycle at the nominal frequency of the search unit is recommended. A sufficient number of cycles should be sampled to reliably reproduce the spectrum of the echo waveform. Averaging a number of waveforms increases the reliability of measurements. Specific requirements may be established between the supplier and user.

NOTE A1.4—When using the shock excitation technique, the returning echo should be gated such that the gate is wider than the echo to ensure that the rising and decaying portions of the waveform are included in the frequency response analysis. If a portion of the time response is excluded from the frequency response, this should be clearly documented by showing the gate position and width relative to the waveform.

A1.3 *Sinusoidal Burst Technique*—The principle is to apply a sinusoidal burst of a known voltage and frequency to the search unit and determine its pulse-echo response. By varying the frequency of the sinusoidal burst across the operating range of the search unit and recording the echo response at each frequency, a plot of the acoustic frequency is obtained (2).

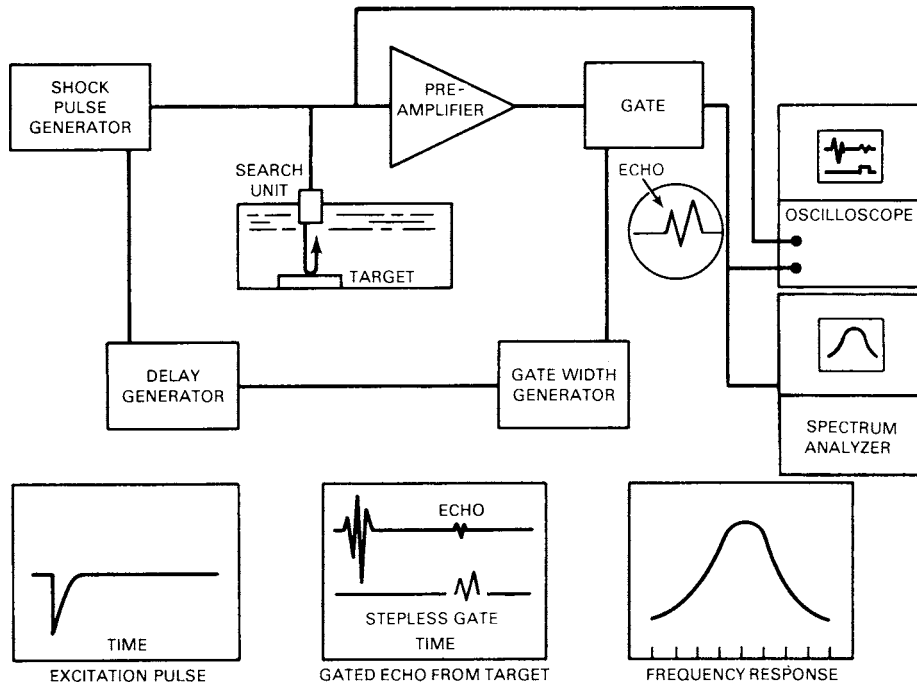

FIG. A1.2 Block Diagram of Shock Excitation System Used to Obtain Analog rf Waveform Information

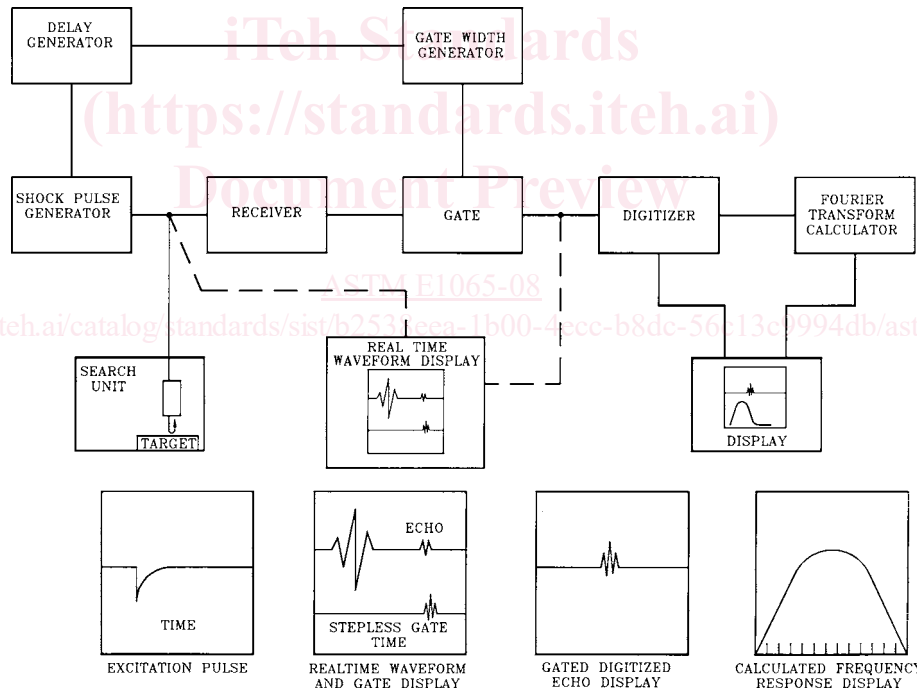

FIG. A1.3 Block Diagram of Shock Excitation System Used to Obtain Digitized rf Waveform Information

A1.3.1 Fig. A1.4 is a block diagram for a system designed for displaying and recording the frequency response. The function generator is adjusted to produce sinusoidal bursts across the range of frequencies anticipated for the operating frequency of the search unit (for example, 1 to 5 MHz for 2.5 MHz, 1 to 10 MHz for 5 MHz, etc.). The generator pulse width is adjusted to provide a minimum pulse duration of 15 cycles at the lowest measurement frequency. The sinusoidal burst (see Fig. A1.4, Position A) is applied to the search unit and the

pulse-echo response from a given target is recorded for a specific frequency. The frequency of the bursts is stepped through the frequency range and the pulse-echo voltage response is recorded at each frequency. The returning echo is gated (Position B) to the center one-half of the echo response to ensure that transients from the generator or electronics do not influence the measurements. Both the amplitude of the applied voltage and the amplitude of the echo response are plotted as a function of frequency (Position C).

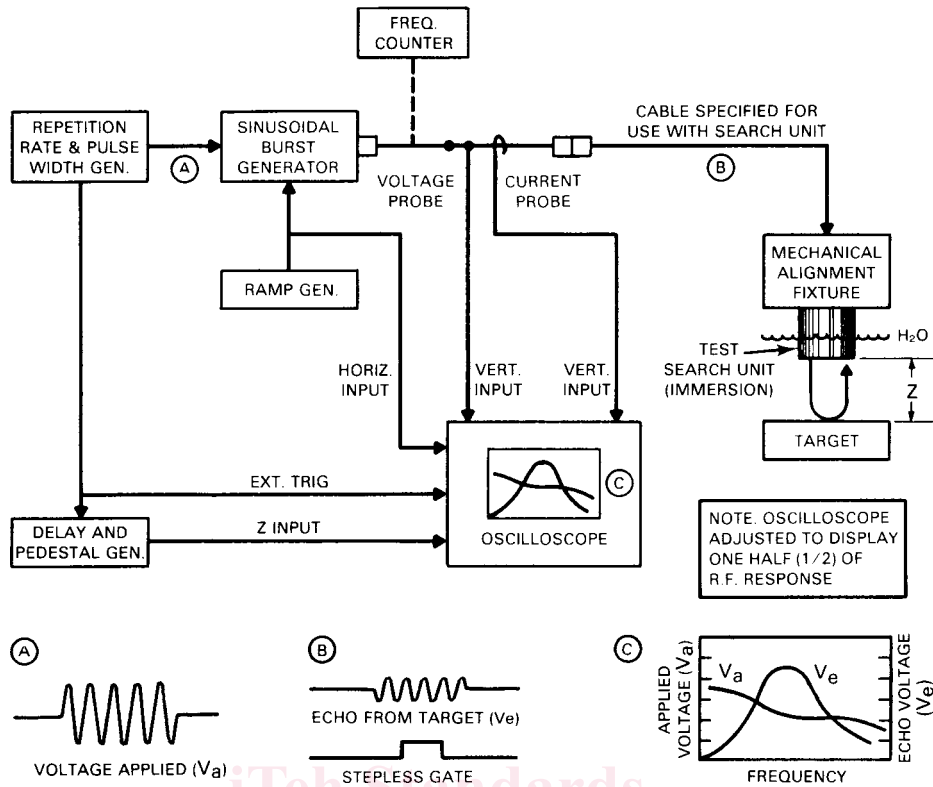

FIG. A1.4 Block Diagram of a Sinusoidal Burst System (Frequency Response)

A1.3.2 *Influence of Generator Output*—Commercial sinusoidal burst generators typically are designed to provide a constant-voltage output into a 50-ohm resistance load. When these generators are loaded by an ultrasonic search unit, the output driving voltage may vary with frequency, depending on the impedance of the search unit.

A1.3.2.1 *Recording Procedure*—The initial step in the sinusoidal burst recording procedure is to terminate the generator with a 50-ohm resistive load and establish that the output voltage is constant over the frequency range of interest. Once this is established, the 50-ohm resistor is removed and the search unit is connected. The frequency response is obtained without further adjustment of the generator drive voltage. The frequency response and the applied voltage are recorded, thereby showing the influence of the electrical impedance of the search unit:

A1.4 *Specific Procedures*—The sinusoidal burst and shock excitation procedures are applicable to nearly all types of search units. The procedures for evaluating the characterization of various styles are outlined as follows:

A1.4.1 *Immersion*—Fig. A1.5 shows the test setup for obtaining frequency response for immersion units.

A1.4.1.1 *Flat Search Units*—Flat or nonfocused search units are adjusted so that the distance from the face of the search unit to the target (Z_0) is 2 in. (50 mm). A flat and smooth glass block with dimensions not smaller than 2 by 2 in. (50 by 50 mm) by 1 in. (25 mm) thick is recommended as the target. A manipulator is used to adjust for a maximum amplitude response from the target.

(a) Thinner blocks may be used for higher frequency search units. Thicker blocks may be used for lower frequency or larger diameter search units, or both, as agreed upon by users of this guide.

(b) All targets or test blocks must have a material thickness that is greater than the sinusoidal burst pulse duration of the excitation voltage.

NOTE A1.5—*Guideline for Analyzing Frequency Response.* Ultrasonic search units used for nondestructive evaluation typically fall with a range of 100 kHz to 100 MHz. For shock excitation, Note A1.3 recommends use of a digitizer with the capability of 10 samples per cycle. For the higher frequencies, this recommendation may be modified by the users, but the digitize capability employed must be documented.

The positioning of the gates is essential for accurately analyzing the frequency response of the search unit. Fig. A1.6 describes examples for positioning the gate settings for the digitizer. The first gate should be set at the initiation of the waveform. The second gate should be set at a position that encompasses the entire waveform to the 20 dB level. Waveform A would indicate an approximate 100 % bandwidth, while Waveform D would indicate a bandwidth of approximately 10 %.

A1.4.1.2 *Focused Search Units*—A ball target should be used to obtain the frequency response of focused search units. The ball should have a diameter that is at least 10 wavelengths in water (for example, 5/8 inch [15 mm] at 1 MHz in water). The distance Z_0 should be adjusted for maximum amplitude response from the target. Care must be taken to ensure that no internal reflections from the ball or creeping wave signals around the ball are included in the recorded response as these can distort the response.

A1.4.2 *Contact Straight Beam*—Measurements for contact straight-beam search units are made with the unit coupled to

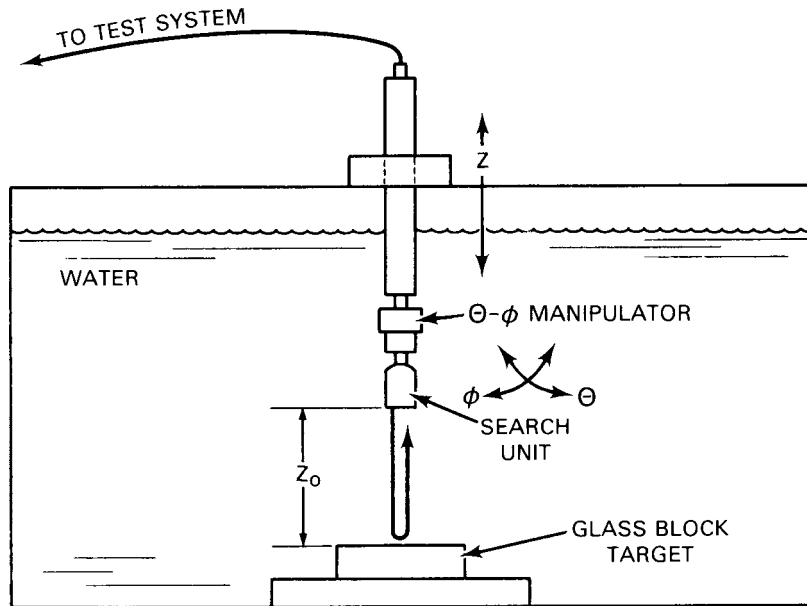

FIG. A1.5 Test Setup for Immersion Search Units

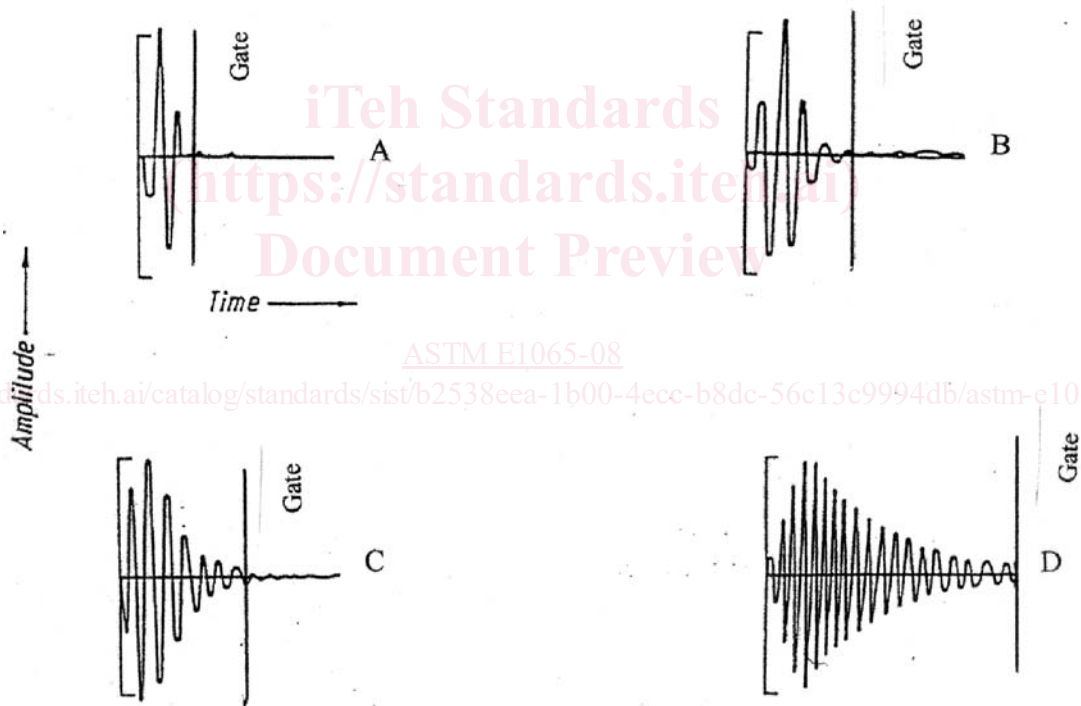

FIG. A1.6 Digitizer Gate Positioning

the test block. Couplant shall be machine oil or other specified fluid. Fig. A1.7 shows the test setup for contact straight-beam search units. A 1½-in. (38-mm) flat (32-μin.) aluminum block, or a block of other suitable material and dimension, may be used for the frequency response measurements. The back surface of the block is used as the target and the echo response from this surface is recorded.

A1.4.2.1 Thinner blocks may be used for higher frequency search units. Thicker blocks may be used for lower frequency or larger diameter search units, or both, as agreed upon by users of this guide.

A1.4.2.2 All targets or test blocks must have a material thickness that is greater than the sinusoidal burst pulse duration of the excitation voltage.

NOTE A1.6—**Caution:** The immersion procedure is *not* valid for evaluating contact straight-beam search units that incorporate a hard wear-face plate.

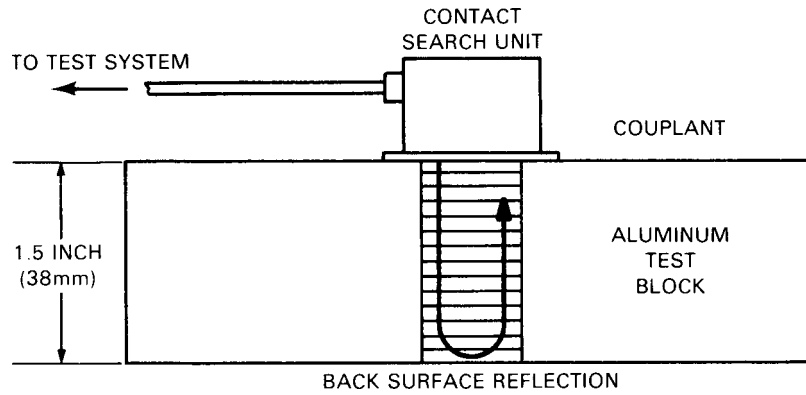

FIG. A1.7 Test Setup for Contact Straight-Beam Search Units

A2. BANDWIDTH MEASUREMENTS

A2.1 The bandwidth (*BW*) (sometimes referred to as functional or operational bandwidth) of a search unit is a selected portion of the frequency response of the search unit.

A2.2 The lower and upper frequency values (f_l and f_u respectively) of the bandwidth are defined as the values at which the amplitude of the pulse-echo response has fallen 6 dB below the peak of the frequency response curve (f_p) (see Fig. A1.1). The peak is chosen as the reference even though it may not be at the center frequency (f_c). Bandwidth measurements are determined by locating the peak response and then selecting the f_l and f_u values.

A2.3 Bandwidth calculations are based on determining the center frequency, f_c , in MHz, of the bandwidth as described as follows:

$$f_c = \frac{f_l + f_u}{2} \quad (A2.1)$$

A2.4 Bandwidth is then calculated as follows:

$$BW = (f_u - f_l) / f_c \times 100 \text{ (percentage)} \quad (A2.2)$$

A2.5 By way of example, the bandwidth for the frequency responses shown in Fig. A1.1 (a) and (b) are as follows:

A2.5.1 *Symmetrical Curve* (Fig. A1.1 (a)):

$$f_c = (4.0 + 6.1) / 2 = 5.05 \text{ MHz} \quad (A2.3)$$

$$BW = (6.1 - 4.0) / 5.05 \times 100 = 42\% \quad (A2.4)$$

A2.5.2 *Asymmetrical Curve* (Fig. A1.1 (b)):

$$f_c = (3.4 + 8.2) / 2 = 5.8 \text{ MHz} \quad (A2.5)$$

$$BW = (8.2 - 3.4) / 5.8 \times 100 = 83\% \quad (A2.6)$$

A3. RELATIVE PULSE-ECHO SENSITIVITY

A3.1 Relative pulse-echo sensitivity (S_{rel}) is defined as follows:

$$S_{rel} = 20 \log V_e / V_a \text{ (expressed in dB)} \quad (A3.1)$$

where V_e is the peak-to-peak voltage response of the echo from the specific reflector as defined in Annex A1, and V_a is the peak-to-peak voltage applied to the search unit. Both V_a and V_e are measured at the nominal frequency (f_{nom}), as stated by the manufacturer's label.

A3.1.1 *Sinusoidal Burst Procedure*—Fig. A3.1 describes the data for establishing S_{rel} from the test results obtained with the sinusoidal burst procedure. The value for S_{rel} is established at f_{nom} . In the example shown:

$$f_{nom} = f_p \quad V_a = 2.0 \text{ V} \quad (A3.2)$$

$$V_e = 200 \text{ mV}$$

$$S_{rel} = 20 \log(0.2/2.0) = -20 \text{ dB}$$

Example B:

$$f_{nom} \neq f_p \quad V_a = 2.0 \text{ V} \quad (A3.3)$$

$$V_e = 0.1 \text{ V}$$

$$S_{rel} = 20 \log(0.1/2.0) = -26 \text{ dB}$$

NOTE A3.1—Relative pulse-echo sensitivity measurements may be made with either analog or digitized rf echo waveforms.

NOTE A3.2—No procedure is given in this guide for determining sensitivity using shock excitation procedures.

Example A:

A3.2 Search unit sensitivity comparisons made with ultrasonic instruments may vary from the values obtained with this procedure and they may vary between types of flaw detectors.

Search unit responses are influenced by the impedance of the pulser, impedance of the search unit and coaxial cable, and the input impedance of the receiver.

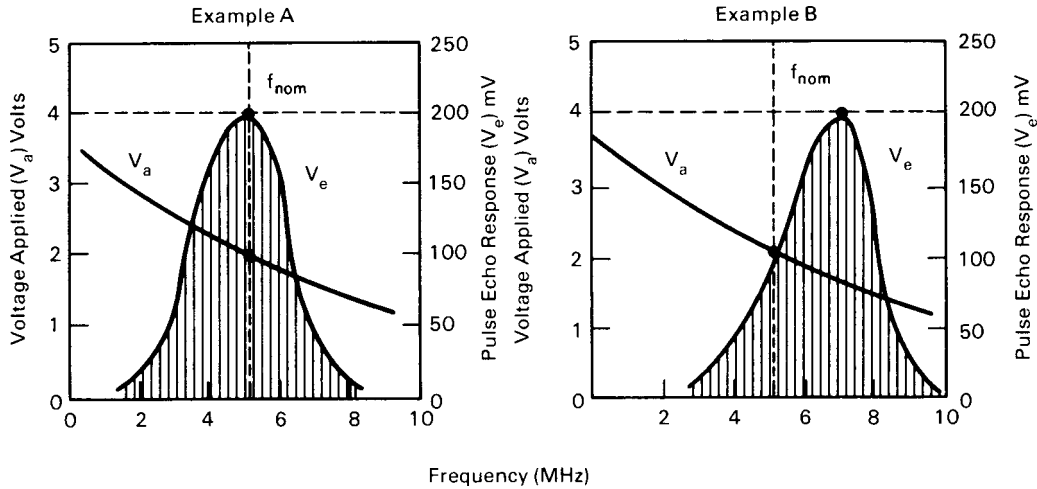

FIG. A3.1 Measurement of Sensitivity from Sinusoidal Burst Frequency Response Curve

A4. MEASUREMENT OF TIME RESPONSE⁵

A4.1 *Time Response*—The time response of a search unit is established from the rf waveform of the echo received from a given target using the pulse-echo procedure. This response is used as the basis for evaluating other operating and recovery parameters of the search unit such as waveform duration and damping (Standard Methods for Testing Single Element Pulse-Echo Ultrasonic Transducers). Typical examples of waveform duration are shown in Fig. A4.1.

A4.2 *Procedure*—The procedure for measuring the time response employs the shock excitation techniques defined in A1.2 and the procedures outlined in A1.4. Fig. A1.2 and Fig. A1.3 illustrate the setup for pulse-echo procedure. Fig. A1.5 and Fig. A1.7 illustrate the test configuration for immersion and contact straight-beam search units.

A4.3 *Time Response Terms and Parameters*—A photograph or printout of the rf waveform from the CRT can be used to describe the time response of the search unit. This record should provide a scaled time base from which the measurement can be defined. Examples are shown in Fig. 1 and Fig. 2. The

terms and parameters selected in the quantitative description of waveforms (for example, waveform duration, resolution, and damping) should be defined and agreed upon by users of this guide. Waveform duration may be measured as a level either 20 or 40 dB below the peak of the pulse-echo response. As the time response can be influenced by the input electronics and impedance of the receiver, care must be taken to ensure that the receiver input is not saturated and that the impedance is high enough (for example, 500 ohms or greater) to accurately record the echo signal.

NOTE A4.1—This guide does not describe a procedure for obtaining “time response” using the sinusoidal burst excitation procedure.

NOTE A4.2—For accurate measurement of the time response of a digitized rf waveform, an 8-bit digitizer is needed. A sufficient number of samples per cycle should be taken that a curve through the sampled values provides a smooth waveform that resembles the original analog waveform. For reliable measurement of peak or low-level waveforms, a minimum sampling of 36 samples per cycle is recommended. An 8-bit digitizer is inherently limited to displaying 48 dB of dynamic range and only half of this range is usable for evaluating an rf waveform, to evaluate low level signals may require increasing the gain of the amplifier. Averaging a number of waveforms increases the reliability. Specific requirements may be established between the supplier and user.

⁵ See AIUM Standard Methods (2.2).