



Designation: D6193 – 09

Standard Practice for Stitches and Seams¹

This standard is issued under the fixed designation D6193; the number immediately following the designation indicates the year of original adoption or, in the case of revision, the year of last revision. A number in parentheses indicates the year of last reapproval. A superscript epsilon (ϵ) indicates an editorial change since the last revision or reapproval.

This standard has been approved for use by agencies of the Department of Defense.

1. Scope

1.1 This practice covers the requirements and characteristics of stitches and seams used in the fabrication of sewn items.

1.2 This practice identifies the category, formation, and general purpose for stitch types and seam types used in the fabrication of sewn items.

1.3 Subsequent to a general discussion of stitches and seams that include schematic indices, this practice is comprised of the following sections that are listed in the order in which they appear:

1.3.1 *Section 5*—Classification of Stitch Types for which drawings are shown in Stitch Figs. 1-69,

1.3.2 *Section 6*—Classification of Seam Types for which drawings are shown in Seam Figs. 70-288, and

1.3.3 *Annex A1*—Seam Assembly Recommendations.

1.4 *This standard does not purport to address all of the safety concerns, if any, associated with its use. It is the responsibility of the user of this standard to establish appropriate safety and health practices and determine the applicability of regulatory limitations prior to use.*

2. Referenced Documents

2.1 *ASTM Standards*:²
[D123 Terminology Relating to Textiles](#)

3. Terminology

3.1 *Definitions*:

3.1.1 *needle damage, n*—in sewn fabrics, the partial or complete yarn severance or fiber fusing caused by a needle passing through a fabric during sewing.

3.1.1.1 *Discussion*—This can also be referred to as needle cuts.

3.1.2 *seam, n*—a line where two or more fabrics are joined, usually near the edge. *See also sewn seam, glued seam, stapled seam, thermally bonded seam.*)

¹ This practice is under the jurisdiction of ASTM Committee D13 on Textiles and is the direct responsibility of Subcommittee D13.54 on Subassemblies.

Current edition approved Jan. 15, 2009. Published March 2009. Originally approved in 1997. Last previous edition approved in 2004 as D6193 – 97(2004). DOI: 10.1520/D6193-09.

² For referenced ASTM standards, visit the ASTM website, www.astm.org, or contact ASTM Customer Service at service@astm.org. For *Annual Book of ASTM Standards* volume information, refer to the standard's Document Summary page on the ASTM website.

TABLE 1 Stitch and Seam Defects

Stitch Defects	Seam Assembly Defects
Loose stitches	Puckers
Poorly formed stitches	Twists
Crowded stitches	Plaits
Tight stitches	Undulations
Crooked stitches	Run-off (raised seams)
Skipped stitches	Raw edges exposed (felled seams)

3.1.3 *seam allowance, n*—in sewn fabrics, the distance from the edge of a fabric to the parallel stitch line furthest from that edge.

3.1.4 *seam assembly, n*—the composite structure obtained when fabric(s) are joined by means of a seam.

3.1.5 *seam damage, n*—in sewn fabrics, an adverse change in the physical condition of one or more of the components in a seam which would reduce the seam acceptability such as yarn slippage, needle damage, or fabric rupture.

3.1.6 *seam efficiency, n*—in sewn fabrics, the ratio of seam strength to fabric strength.

3.1.6.1 *Discussion*—For some constructions, yarn strength and stitch type can contribute to a higher seam efficiency value.

3.1.7 *seam slippage, n*—in sewn fabrics, the displacement of the fabric yarn parallel and adjacent to the stitch line.

3.1.8 *seam type, n*—in sewn fabrics, an alphanumeric designation relating to the essential characteristics of fabric positioning and rows of stitching in a specified sewn fabric seam.

3.1.9 *sew, v*—to unite or fasten with stitches.

3.1.10 *sewing thread, n*—a flexible, small-diameter yarn or strand, usually treated with a surface coating, lubricant, or both, intended to be used to stitch one or more pieces of material or an object to a material.

3.1.11 *sewn seam, n*—in sewn fabrics, a juncture at which two or more planar structures such as textile fabrics, are joined by sewing, usually near the edge.

3.1.12 *stitch, n*—in sewing, the configuration of the interlacing of sewing thread in a specific repeated unit. (See also *stitching, and stitch type.*)

3.1.13 *stitch density, n*—in sewn seams, the number of stitches per unit length in one row of stitching in the seam.

3.1.13.1 *Discussion*—This is usually expressed as stitches per inch (spi).

DIRECTION OF SUCCESSIVE STITCH FORMATION

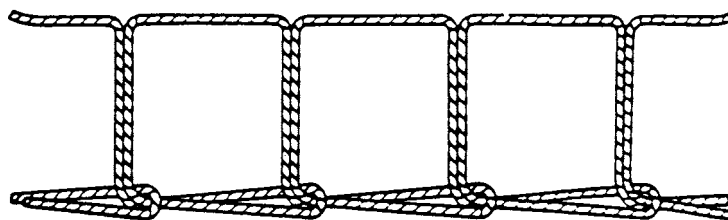

NOTE 1—This type of stitch shall be formed with one needle thread that shall be passed through the material and interlooped with itself on the undersurface of the material.

FIG. 1 Stitch Type 101

DIRECTION OF SUCCESSIVE STITCH FORMATION

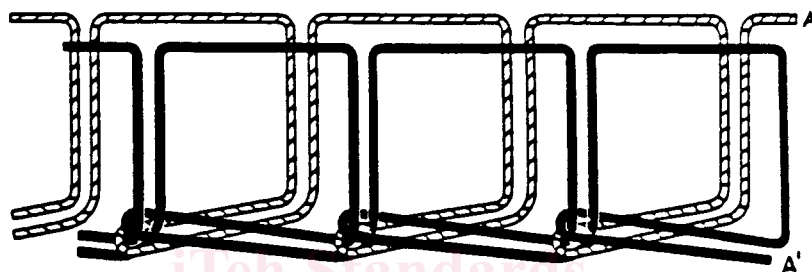

NOTE 1—This type of stitch shall be formed with two needle threads A and A'. Both threads shall be passed through the material and thread A' shall be interlooped with itself and with thread A.

FIG. 2 Stitch Type 102

DIRECTION OF SUCCESSIVE STITCH FORMATION

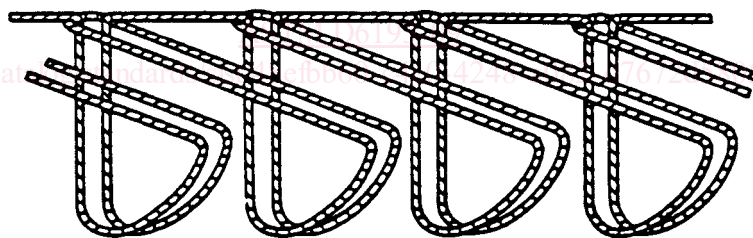

NOTE 1—This type of stitch shall be formed with one needle thread, which shall interloop with itself on the top surface of the material. The thread shall be passed through the top ply and horizontally through portions of the bottom ply without penetrating it the full depth.

FIG. 3 Stitch Type 103

3.1.14 *stitch gage, n*—in sewn seams, the perpendicular distance between adjacent parallel rows of stitching.

3.1.15 *stitch type, n*—in sewn seams, a numerical designation relating to the essential characteristics of the interlacing of sewing thread(s) in a specified stitch.

3.1.16 *stitching, n*—a series of stitches embodied in a material or materials of planar structure such as woven textile fabrics usually for ornamental purposes or finishing an edge, or both.

3.1.17 *yarn slippage, n*—in sewn seams in sewn fabrics, the displacement of one or more yarns from the original position, causing differences in alignment, spacing, or both.

3.2 For definitions of other textile terms used in this practice, refer to Terminology D123.

4. Significance and Use

4.1 Seam engineering, the determination of the best stitch type, seam configuration, and thread type which should be used for a particular assembly, requires a thorough knowledge of many variables. The improper selection of any one component can result in failure of the sewn junction, and ultimately failure of the product manufactured.

4.2 *General Characteristics*—The characteristics of a properly constructed sewn seam are strength, elasticity, durability,

DIRECTION OF SUCCESSIVE STITCH FORMATION

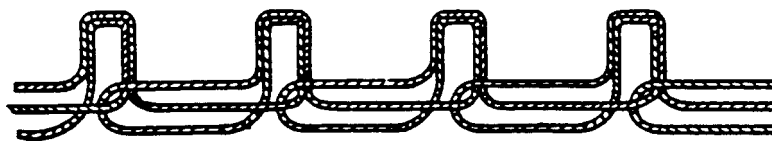

NOTE 1—This type of stitch shall be formed with one needle thread which shall interloop with itself on the undersurface of the material.

FIG. 4 Stitch Type 104

DIRECTION OF SUCCESSIVE STITCH FORMATION

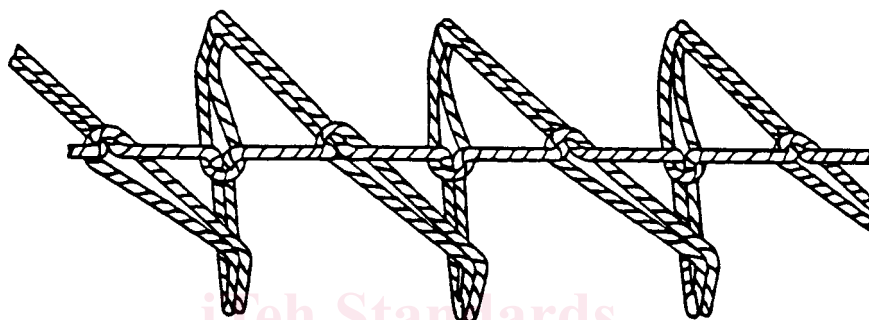

NOTE 1—This type of stitch shall be formed with one needle thread which shall be passed through the top ply of material and through portions of the bottom ply without penetrating it the full depth, on either side of a center line. The thread shall interloop with itself on the surface of the material at the center line.

FIG. 5 Stitch Type 105

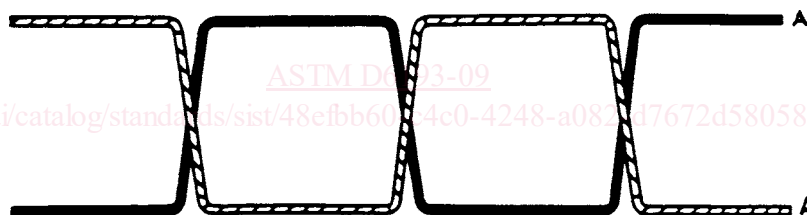

NOTE 1—This type of stitch shall be formed with two needle threads, A and A', which shall be passed through the material in the same perforations from opposite directions without interlacing or interlooping.

FIG. 6 Stitch Type 201

security, and appearance. These characteristics must be balanced with the properties of the material to be joined to form the optimum sewn seam. The end use of the item will govern the relative importance of these characteristics. The selection of the seam type and stitch type should be based upon these considerations.

4.2.1 *Strength*—The seam efficiency of the sewn seam should be as high as possible. This will produce sewn seam strength with a balanced construction that will withstand the forces encountered in the use of the sewn item. The elements affecting the strength of a sewn seam are:

- 4.2.1.1 Fabric type and strength,
- 4.2.1.2 Seam type,
- 4.2.1.3 Stitch type,
- 4.2.1.4 Stitch density (spi),

- 4.2.1.5 Thread tension, and
- 4.2.1.6 Thread strength.

4.2.2 *Elasticity*—The elasticity of a sewn seam should be slightly greater than that of the material which it joins. This will enable the material to support its share of the forces encountered for the intended end use of the sewn item. The elasticity of a sewn seam depends upon:

- 4.2.2.1 Fabric type and strength,
- 4.2.2.2 Seam type,
- 4.2.2.3 Stitch type,
- 4.2.2.4 Stitch density (spi),
- 4.2.2.5 Thread tension, and
- 4.2.2.6 Thread elasticity.

4.2.3 *Durability*—The durability of a sewn seam depends largely upon its strength relative to the elasticity of the seam

DIRECTION OF SUCCESSIVE STITCH FORMATION

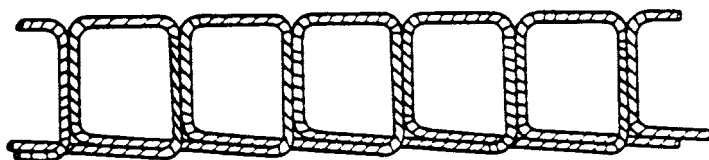

NOTE 1—This type of stitch shall be formed with one needle thread, which shall be passed through the material brought forward two stitch lengths, passed back through the material and brought back one stitch length before being passed through the material a third time.

FIG. 7 Stitch Type 202

DIRECTION OF SUCCESSIVE STITCH FORMATION

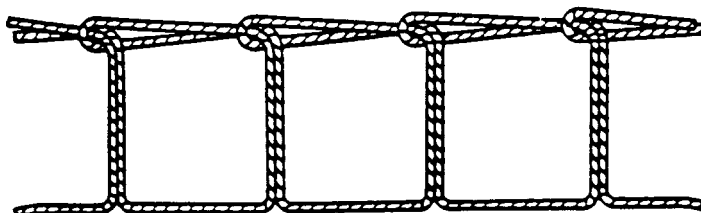

NOTE 1—This type of stitch shall be formed with one needle thread, which shall be passed through the material from the underside and immediately passed back through the same perforation to form a loop on the surface of the material. The needle shall be advanced one stitch length, passed through the material and the loop and immediately passed back through the loop and the same needle perforation, and a new loop shall be formed to receive the succeeding stitch.

FIG. 8 Stitch Type 203

DIRECTION OF SUCCESSIVE STITCH FORMATION

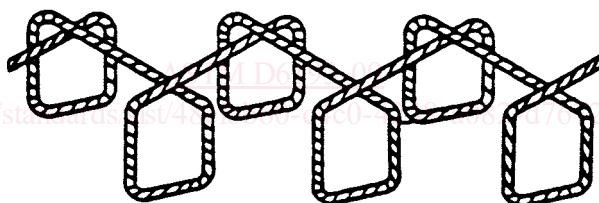

NOTE 1—This type of stitch shall be formed with one needle thread, which shall be passed through the material and brought back one stitch length and then passed back up through the material. The needle shall be moved diagonally across the material and forward one stitch length, passed through the material, brought back one stitch length and again passed to the surface of the material. This process shall be repeated to form a crisscross pattern of stitches on the surface and parallel rows of separated and off-set stitches on the underside of the material.

FIG. 9 Stitch Type 204

and the elasticity of the material. However, in less elastic, tightly woven or dense materials, there is a tendency for the plies to “work” or slide on each other. To form a durable sewn seam in these types of fabrics, the thread size must be carefully chosen. The stitch density also needs to be carefully determined for the material so as not to cause excess tension which will unbalance the elasticity and cause puckering. It is also important to minimize abrasion and wear by contact with outside agencies to promote durability.

4.2.4 *Security*—The security of a sewn seam depends chiefly upon the stitch type, spi, and its susceptibility to become unraveled. The stitch must be well set to the material to prevent snagging that can cause rupture of the thread and unraveling of certain stitch types.

4.2.5 *Appearance*—The appearance of a sewn seam generally is governed by the proper relationship between the size and type of thread, the stitch density, and the texture and weight of the fabric.

4.2.5.1 In addition to these general characteristics, the technique and skill of the sewing machine operators also govern the appearance of the sewn seams. Some of the factors which will adversely affect the appearance are shown in **Table 1**.

5. Classification of Stitch Types

5.1 *Function*—Because all stitch types require that a needle penetrate a fabric while transporting a sewing thread, it is important to understand how the unique characteristics of

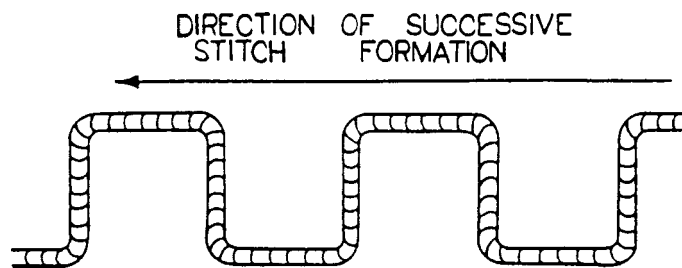

NOTE 1—This type of stitch shall be formed with one or more needle threads and has for a general characteristic that the thread does not interloop with itself or any other thread or threads. The thread is passed completely through the material by means of a double pointed center eye needle and returned by another path. This class of stitch simulates hand stitching.

FIG. 10 Stitch Type 205

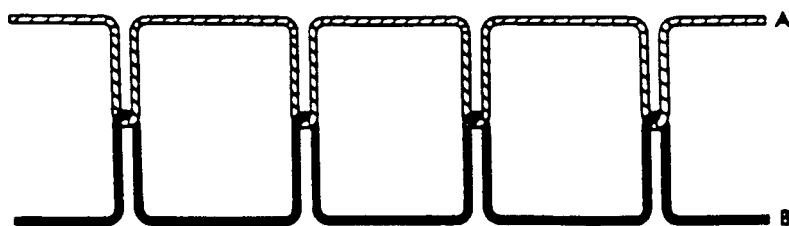

NOTE 1—This type of stitch shall be formed with two threads: one needle thread, A, and one bobbin thread, B. A loop of thread A shall be passed through the material and interlaced with thread B. Thread A shall be pulled back so that the interlacing shall be midway between surfaces of the material or materials being sewn.

FIG. 11 Stitch Type 301

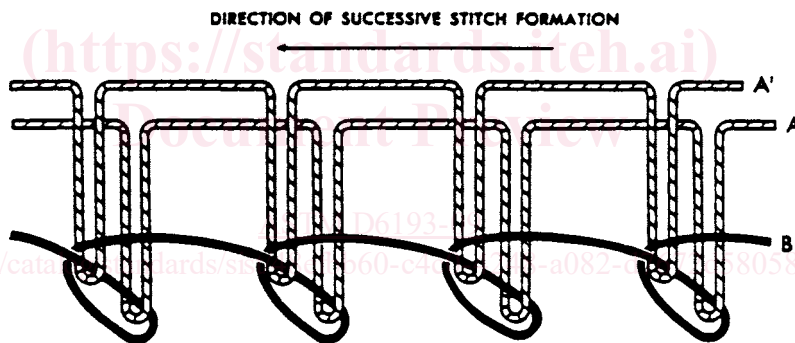

NOTE 1—This type of stitch shall be formed with three threads: two needle threads, A and A', and one bobbin thread, B. Loops of threads A and A' shall be passed through the material and interlaced with thread B. The interlacings shall be on the underside of the material.

FIG. 12 Stitch Type 302

every stitch type are dependent upon the mechanical actions of the sewing machine. See Stitch Type Figs. 1-66.

5.2 *Stitch Requirements:*

5.2.1 Stitches are divided into six classes which are identified by the first digit of three digit numerals. Each class is divided into several types which are identified by the second and third digit. All stitch types shall conform to the drawings unless otherwise specified.

5.2.1.1 *Stitch Class 100*—This class of stitch (Types 101 through 105) is formed with one or more needle threads and requires interlooping. A loop (or loops) of thread(s) shall be passed through the material and be secured by interlooping with succeeding loop or loops, after they are passed through the material, to form a stitch.

5.2.1.2 *Stitch Class 200*—This class of stitch (Types 201 through 205) is formed by hand with one or more needle

threads and requires that each thread passes through the material as a single line of thread. Each stitch is secured by the single line of thread passing in and out of the material or the interlooping of the threads with themselves. When more than one thread is used, the threads pass through the same perforations in the material.

5.2.1.3 *Stitch Class 300*—This class of stitch (Types 301 through 316) is formed with two or more groups of threads and requires the interlacing of the two groups. Loops of the first group are passed through the material where they are secured by the thread(s) of the second group to form a stitch.

5.2.1.4 *Stitch Class 400*—This class of stitch (Types 401 through 407) shall be formed with two or more groups of threads and requires the interlacing and interlooping of the loops of the two groups. Loops of the first group of threads are

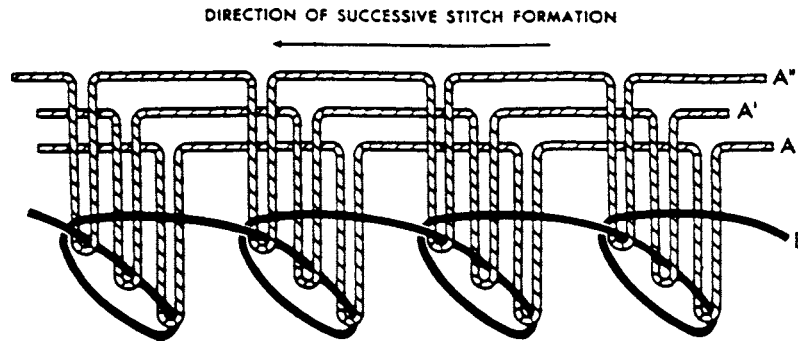

NOTE 1—This type of stitch shall be formed with four threads: three needle threads, A and A' and A'', and one bobbin thread, B. Loops of threads A, A' and A'' shall be passed through the material and interlaced with thread B. The interlacings shall be on the underside of the material.

FIG. 13 Stitch Type 303

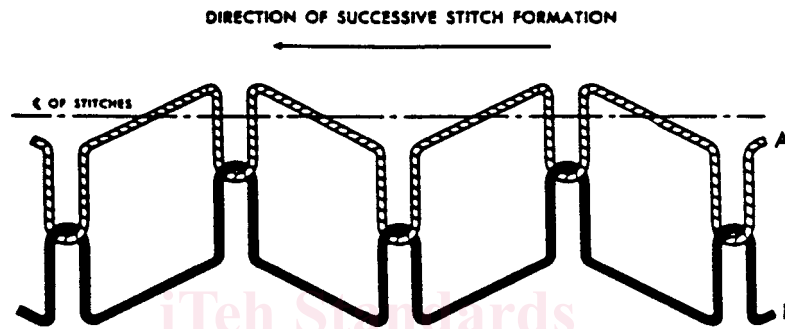

NOTE 1—This type of stitch shall be formed with two threads: one needle thread, A, and one bobbin thread, B. This stitch type is exactly the same as stitch type 301 except that successive single stitches form a symmetrical zigzag pattern.

FIG. 14 Stitch Type 304

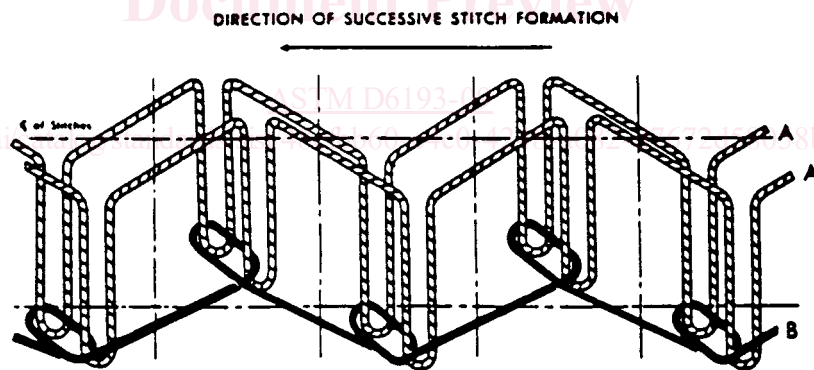

NOTE 1—This type of stitch shall be formed with three threads: two needle threads, A and A', and one bobbin thread, B. Loops of threads A and A' shall be passed through the material and interlaced with thread B and the interlacing shall be left on the underside of the material. Successive single stitches form a symmetrical zigzag pattern.

FIG. 15 Stitch Type 305

passed through the material and are secured by interlacing and interlooping with loops of the second group to form a stitch.

5.2.1.5 *Stitch Class 500*—This class of stitch (Types 501 through 522) is formed with one or more groups of thread, and requires that loops from at least one group of thread shall pass around the edge of the material. Loops of one group of thread are passed through the material and are secured by interlooping with themselves before succeeding loops are passed through the material, or secured by interlooping with loops of one or more interlooped groups of threads before succeeding loops of the first group are again passed through the material.

5.2.1.6 *Stitch Class 600*—This class of stitch (Types 601 through 607) is formed with two or more groups of threads, and requires that two of the groups cover the raw edges of both surfaces of the material. Loops of the first group of thread are passed through loops of the third group already cast on the surface of the material and then through the material where they are interlooped with loops of the second group of thread on the underside of the material. The one exception to this procedure is stitch type 601 where only two groups of thread are used and the function of the third group is performed by one of the threads in the first group.

DIRECTION OF SUCCESSIVE STITCH FORMATION

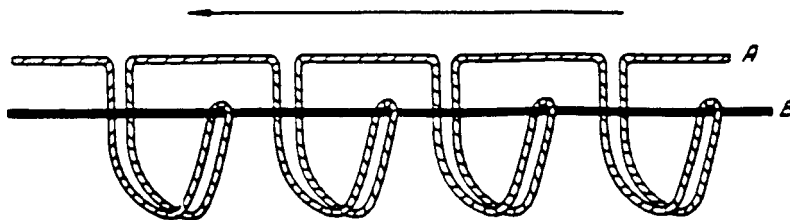

NOTE 1—This type of stitch shall be formed with two threads: one needle thread, A, and one bobbin thread, B. Loops of thread A shall be passed through the top ply of material and horizontally through portions of the bottom ply without penetrating it the full depth and shall be interlaced with thread B on the top surface of the bottom ply of material.

FIG. 16 Stitch Type 306

DIRECTION OF SUCCESSIVE STITCH FORMATION

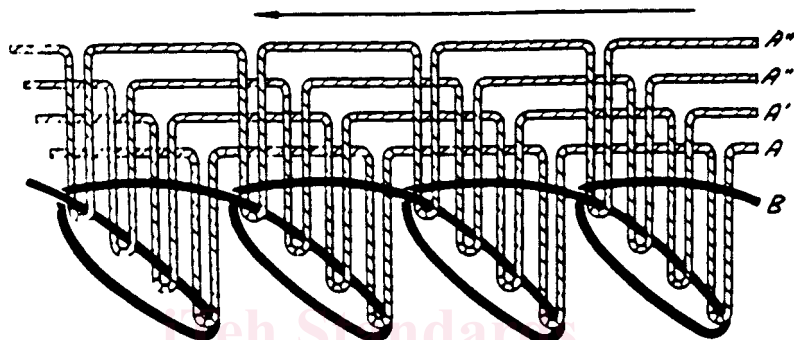

NOTE 1—This type of stitch shall be formed with five threads: four needle threads, A, A', A'', A''', and one bobbin thread, B. Loops of threads A, A', A'', A''', shall be passed through the material and interlaced with thread B. The interlacings shall be on the underside of the material.

FIG. 17 Stitch Type 307

DIRECTION OF SUCCESSIVE STITCH FORMATION

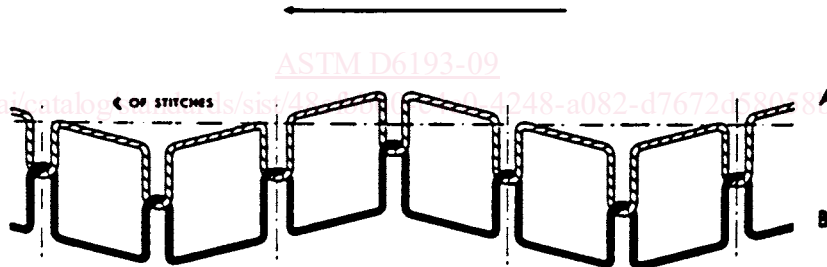

NOTE 1—This type of stitch shall be formed with two threads: one needle thread, A, and one bobbin thread, B. This stitch type is the same as stitch type 304 except that successive pairs of stitches form a symmetrical zigzag pattern.

FIG. 18 Stitch Type 308

6. Classification of Seam Types

6.1 Function:

6.1.1 Seam classification relates directly to the positioning of fabric sections at the junction where these sections are sewn.

6.1.2 All seam types are classified by an alphabetical designation. See Figs 282–291.

6.1.3 Seams are divided into six classes. Each class is subdivided into types and are designated by symbols as follows:

6.1.3.1 *Class of Seam*—Two or more upper case letters.

6.1.3.2 *Types of the Class*—One or more lower case letters.

6.1.3.3 *Number of Rows of Stitches*—One or more Arabic numerals. *Example*—The symbol for a simple super-imposed seam type with one row of stitches is: SSa-1.

6.1.3.4 Generally, most seam types can be produced using multiple rows of stitching. The symbol for the seam type will change with the number of rows of stitches: SSa-2, SSa-3, SSa-4, etc.

6.2 *Seam Requirements:*

DIRECTION OF SUCCESSIVE STITCH FORMATION

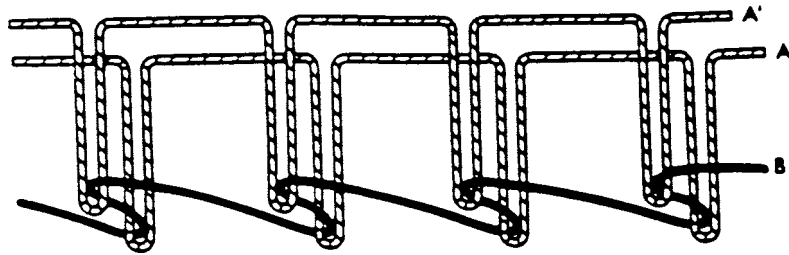

NOTE 1—This type of stitch shall be formed with three threads: two needle threads, A and A', and one bobbin thread, B. Loops of threads A and A' shall be passed through the material and interlaced with thread B. The interlacings shall be left on the underside of the material.

FIG. 19 Stitch Type 309

DIRECTION OF SUCCESSIVE STITCH FORMATION

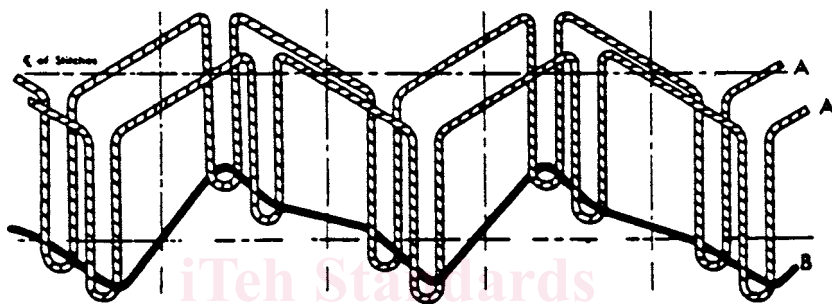

NOTE 1—This type of stitch shall be formed with three threads: two needle threads, A and A', and one bobbin thread, B. Loops of threads A and A' shall be passed through the material and interlaced with thread B, and the interlacings shall be left on the underside of the material. Successive single stitches form a symmetrical zigzag pattern.

FIG. 20 Stitch Type 310

DIRECTION OF SUCCESSIVE STITCH FORMATION

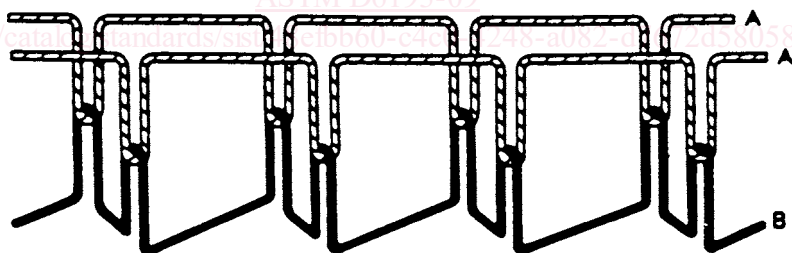

NOTE 1—This type of stitch shall be formed with three threads: two needle threads, A and A', and one bobbin thread, B. Loops of threads A and A' shall be passed through the material and interlaced with thread B. Threads A and A' shall be pulled back so that the interlacings shall be midway between surfaces of the material or materials being sewn.

FIG. 21 Stitch Type 311

6.2.1 All seam types shall conform to the applicable drawings unless otherwise specified. See Seam Figs. 70-288.

6.2.1.1 *Seam Class SS*—This class of seam requires that the plies of material are superimposed and seamed with one or more rows of stitches (Figs. 289-298).

6.2.1.2 *Seam Class LS*—This class of seam requires that the plies of material are lapped and seamed with one or more rows of stitches.

6.2.1.3 *Seam Class BS*—This class of seam is formed by folding a binding strip over the edge of one or more plies of

material and seaming the binding strip to the material with one or more rows of stitches.

6.2.1.4 *Seam Class FS*—This class of seam is formed by sewing the abutted edges of material together in such a manner that the stitches extend across and cover or tend to cover the edges of the plies joined.

6.2.1.5 *Seam Class OS*—This class of seam requires that a series of stitches are embodied in a material either in a straight line, a curve, or following a design, for ornamental purposes.

DIRECTION OF SUCCESSIVE STITCH FORMATION

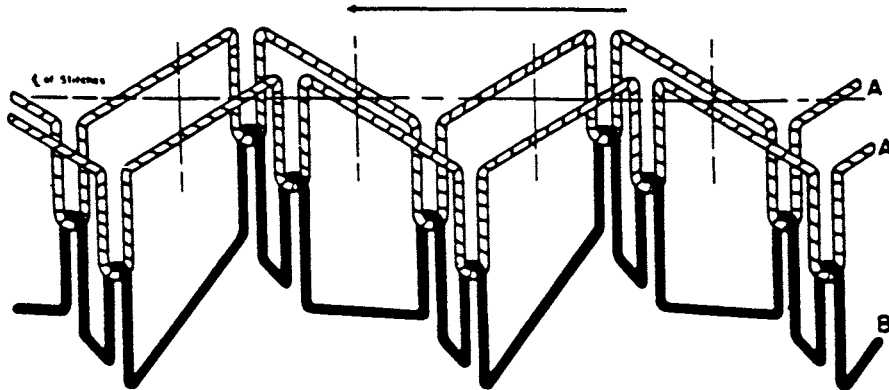

NOTE 1—This type of stitch shall be formed with three threads: two needle threads, A and A', and one bobbin thread, B. This stitch type is exactly the same as stitch type 311 except that successive single stitches form a symmetrical zigzag pattern.

FIG. 22 Stitch Type 312

DIRECTION OF SUCCESSIVE STITCH FORMATION

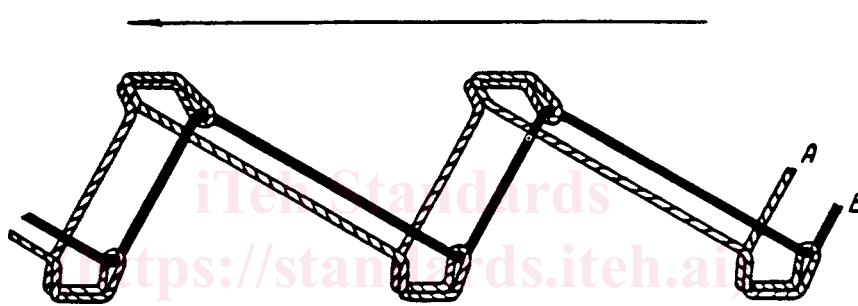

NOTE 1—This type of stitch shall be formed with two threads: one needle thread, A, and one bobbin thread, B. Loops of thread A shall be passed horizontally through portions of both plies of material without penetrating the full depth, and shall be interlaced with thread B on the top of the material.

FIG. 23 Stitch Type 313

DIRECTION OF SUCCESSIVE STITCH FORMATION

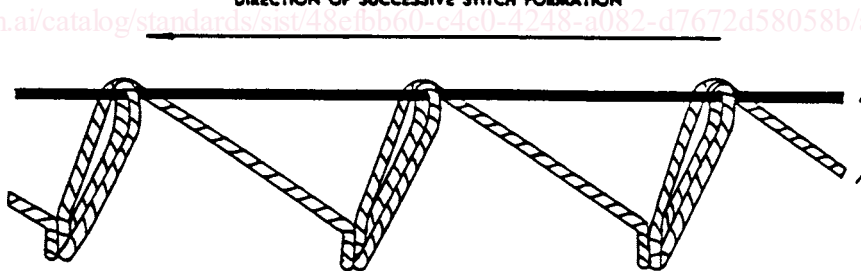

NOTE 1—This type of stitch shall be formed with two threads: one needle thread, A, and one bobbin thread, B. Loops of thread A shall be passed through the top ply of material and horizontally through portions of the bottom ply without penetrating the full depth and shall be interlaced with thread B on the top of the material.

FIG. 24 Stitch Type 314

6.2.1.6 *Seam Class EF*—This class of seam requires that edge finishing is accomplished by either: sewing a series of stitches at or over the edge of a material while the edge may or

may not be folded as specified, or the edge of the material is folded and stitched to the body of the material with a series of stitches.

DIRECTION OF SUCCESSIVE STITCH FORMATION

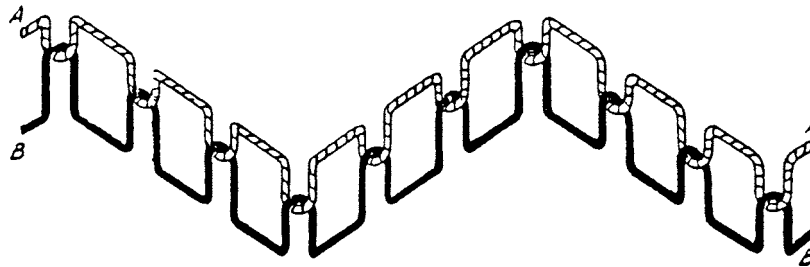

NOTE 1—This type of stitch shall be formed with two threads: one needle thread, A, and one bobbin thread, B. This stitch type is the same as stitch type 304 except that successive groups of three stitches form a symmetrical zig-zag pattern.

FIG. 25 Stitch Type 315

DIRECTION OF SUCCESSIVE STITCH FORMATION

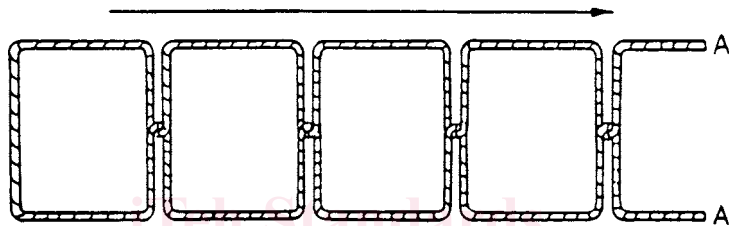

NOTE 1—This type of stitch shall be formed with one continuous needle thread, which after the first needle penetration is divided into two parts: part one, needle thread A, and one reel thread, A'. In subsequent penetrations thread A is passed through the material and interlaced with thread A'. Thread A shall be pulled up so that the interlacing is midway between the surfaces of the material or materials being sewn. This stitch type is identical to stitch type 301 except for the initial stitch.

FIG. 26 Stitch Type 316

DIRECTION OF SUCCESSIVE STITCH FORMATION

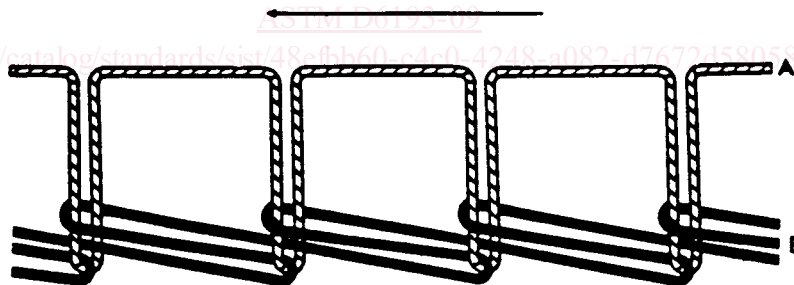

NOTE 1—This type of stitch shall be formed with two threads: one needle thread, A, and one looper thread, B. Loops of thread A shall be passed through the material and interlaced and interlooped with loops of thread B. The interloopings shall be drawn against the underside of the bottom ply of material.

FIG. 27 Stitch Type 401

DIRECTION OF SUCCESSIVE STITCH FORMATION

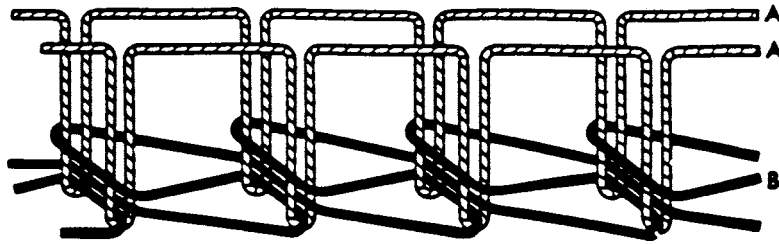

NOTE 1—This type of stitch shall be formed with three threads: two needle threads A and A' and one looper thread, B. Loops of threads A and A' shall be passed through the material and interlaced and interlooped with loops of thread B. The interloopings shall be drawn against the underside of the material.

FIG. 28 Stitch Type 402

DIRECTION OF SUCCESSIVE STITCH FORMATION

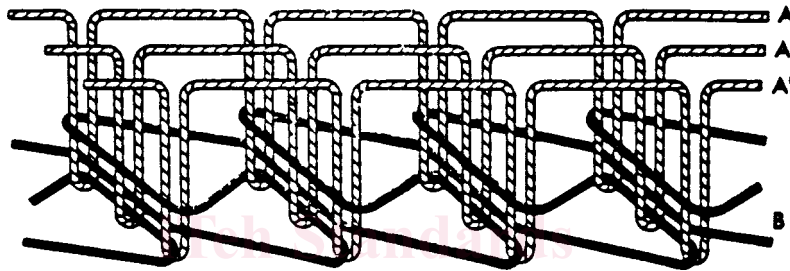

NOTE 1—This type of stitch shall be formed with four threads: three needle threads, A, A' and A'' and one looper thread, B. Loops of threads A, A' and A'' shall be passed through the material and interlaced and interlooped with loops of thread B. The interloopings shall be drawn against the underside of the material.

FIG. 29 Stitch Type 403

DIRECTION OF SUCCESSIVE STITCH FORMATION

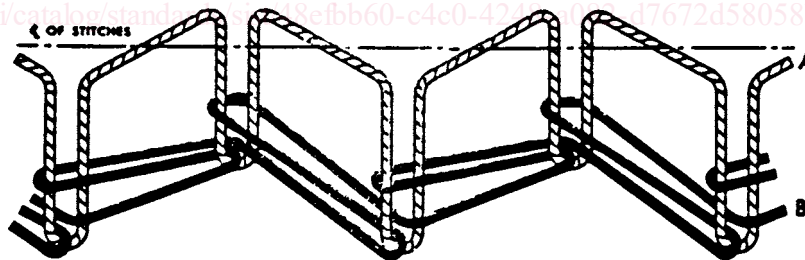

NOTE 1—This type of stitch shall be formed with two threads: one needle thread, A, and one looper thread, B. This stitch is the same as stitch type 401 except that successive single stitches form a symmetrical zigzag pattern.

FIG. 30 Stitch Type 404

DIRECTION OF SUCCESSIVE STITCH FORMATION

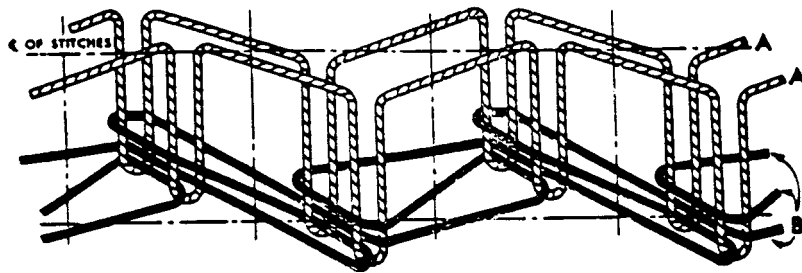

NOTE 1—This type of stitch shall be formed with three threads: two needle threads, A and A', and one looper thread, B. This stitch is the same as stitch type 402 except that successive stitches form a symmetrical zigzag pattern.

FIG. 31 Stitch Type 405

DIRECTION OF SUCCESSIVE STITCH FORMATION

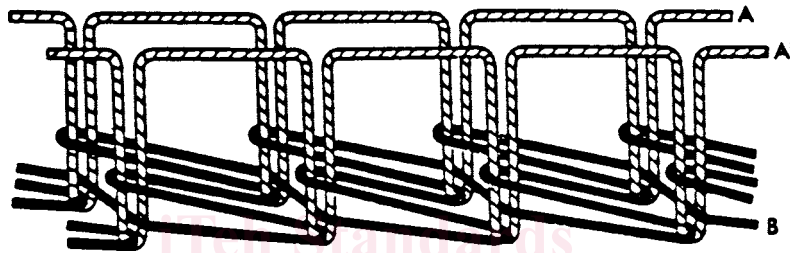

NOTE 1—This type of stitch shall be formed with three threads: two needle threads, A and A' and one looper thread, B. Loops of threads A and A' shall be passed through the material and interlaced and interlooped with loops of thread B. The interloopings shall be drawn against the underside of the material.

FIG. 32 Stitch Type 406

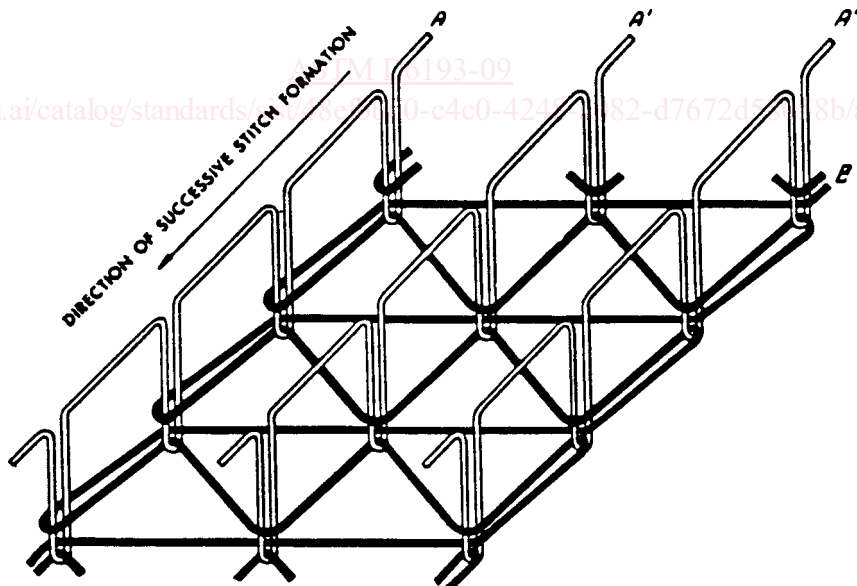

NOTE 1—This type of stitch shall be formed with four threads: three needle threads A, A', and A'' and one looper thread, B. Loops of threads A, A', and A'' shall be passed through the material and shall be drawn against the underside of the material.

FIG. 33 Stitch Type 407

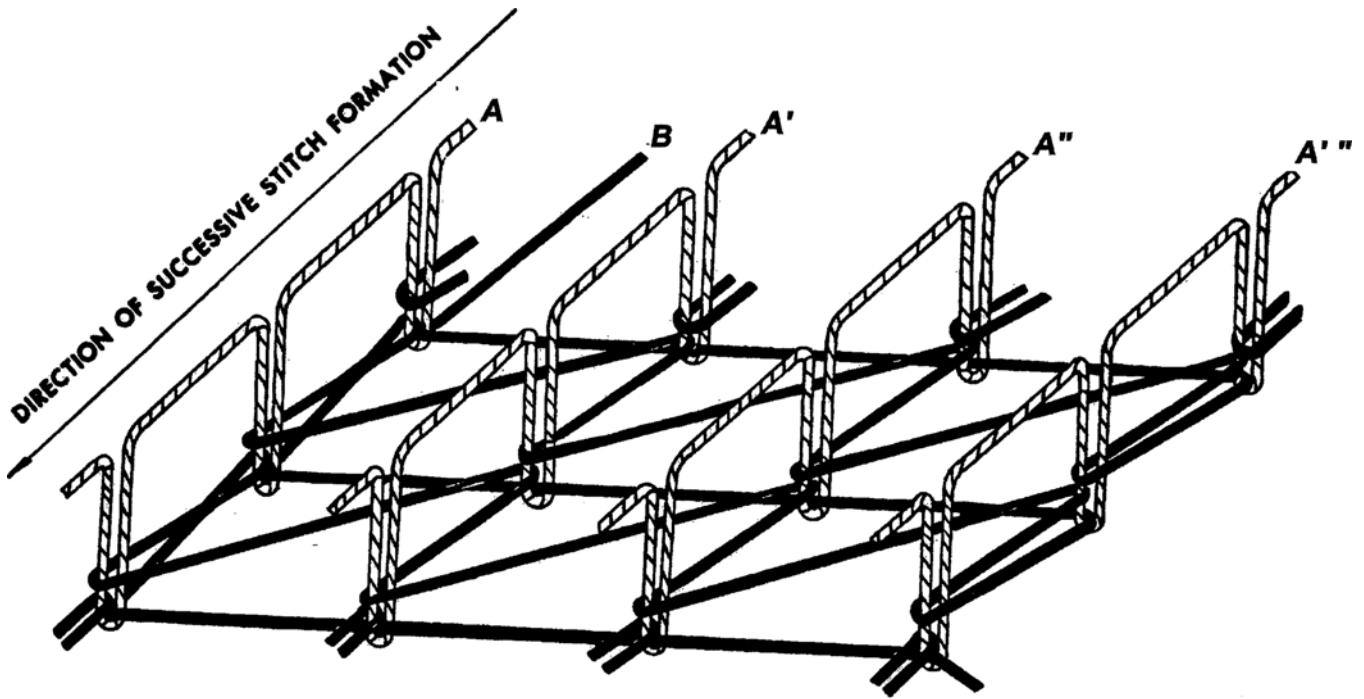

NOTE 1—This type of stitch shall be formed with five threads: four needle threads A, A', A'', and A'''; and one looper thread, B. Loops of threads A, A', A'', and A''' shall pass through the material where they shall be interlooped with the loops of thread B on the underside.

FIG. 34 Stitch Type 408

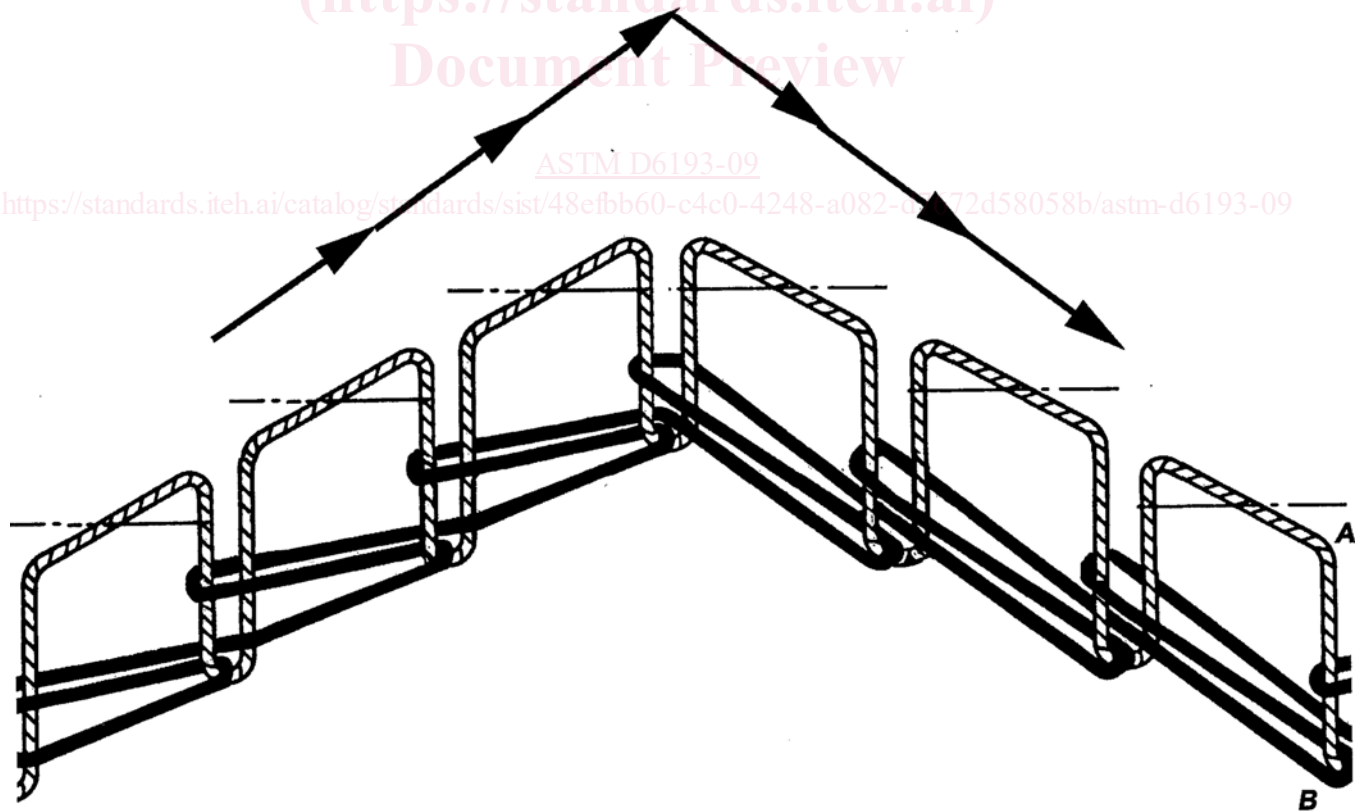

NOTE 1—This type of stitch shall be formed with two threads: one needle threads A, and one looper thread, B. This stitch is the same as stitch type 404, except that successive groups of three stitches form a symmetrical chainstitch zig zag pattern.

FIG. 35 Stitch Type 409

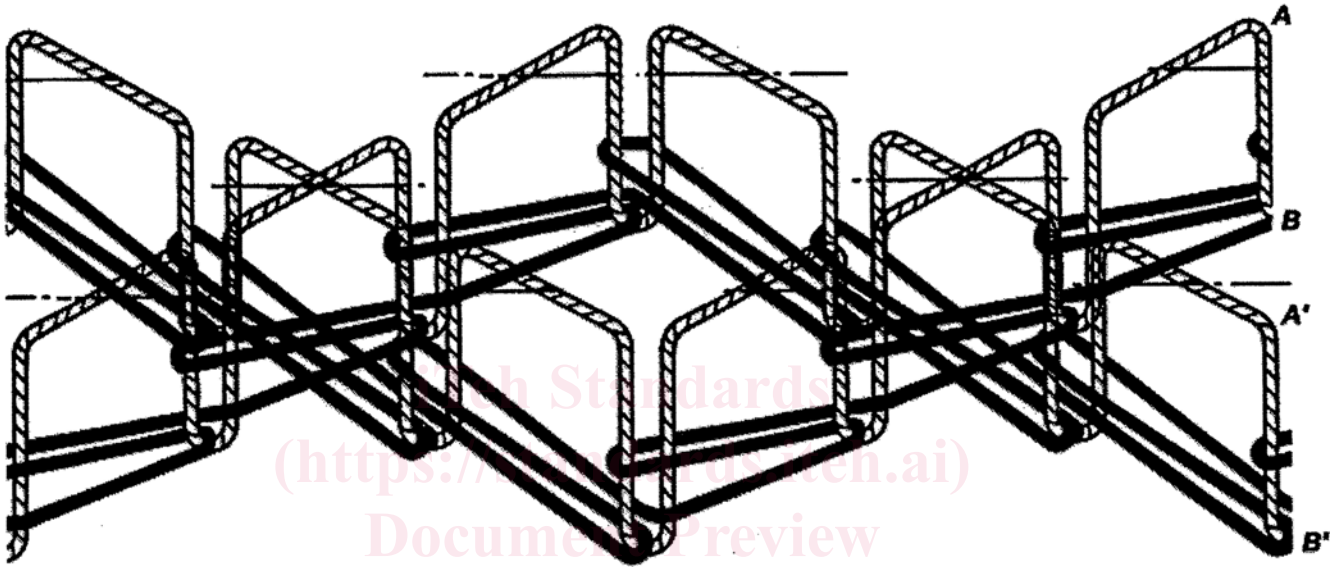
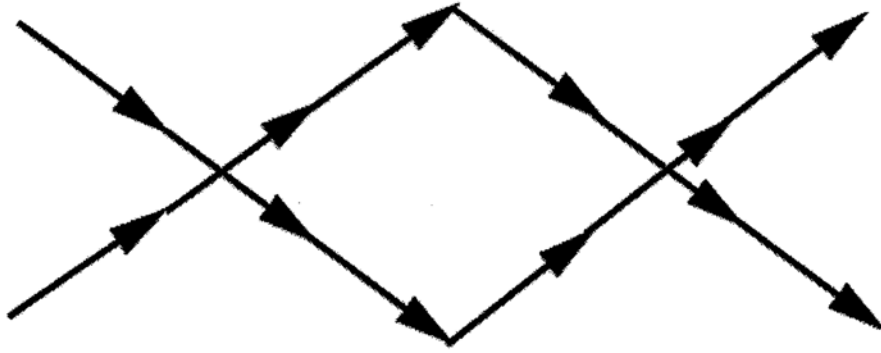

NOTE 1—This type of stitch shall be formed with four threads: two needle threads A, and A', and two looper threads, B and B'. This stitch is the same as stitch type 409, except two successive groups of three stitches form a symmetrical chainstitch zig zag pattern.

FIG. 36 Stitch Type 410

<https://standards.iteh.ai/catalog/standards/sist/46c1b566-6169-4243-a082-d7672d58058b/astm-d6193-09>