

SLOVENSKI STANDARD

SIST EN 508-3:2021

01-december-2021

Nadomešča:
SIST EN 508-3:2008

Pločevina za pokrivanje streh in oblaganje sten - Specifikacije za samonosilne proizvode iz jeklene, aluminijeve pločevine ali pločevine iz nerjavnega jekla - 3. del: Nerjavno jeklo

Roofing and cladding products from metal sheet - Specification for self-supporting products of steel, aluminium or stainless steel sheet - Part 3: Stainless steel

Dachdeckungs- und Wandbekleidungselemente aus Metallblech - Spezifikation für selbsttragende Dachdeckungsprodukte aus Stahlblech, Aluminiumblech oder nichtrostende Stahlblech - Teil 3: Nichtrostender Stahlblech

[SIST EN 508-3:2021](https://standards.iteh.ai/catalog/standards/sist/8b2fd23b-db42-4d37-baa5-7a500376ba05a/en-508-3-2021)

Produits de couverture et bardage en tôle métallique - Spécification pour les produits autoportants en tôle d'acier, d'aluminium ou d'acier inoxydable - Partie 3 : Acier inoxydable

Ta slovenski standard je istoveten z: EN 508-3:2021

ICS:

77.140.50	Ploščati jekleni izdelki in polizdelki	Flat steel products and semi-products
91.060.20	Strehe	Roofs

SIST EN 508-3:2021 en,fr,de

iTeh STANDARD PREVIEW
(standards.iteh.ai)

[SIST EN 508-3:2021](#)

<https://standards.iteh.ai/catalog/standards/sist/8b2fd23b-db42-4d37-baa5-1abd0db4cbac/sist-en-508-3-2021>

EUROPEAN STANDARD

EN 508-3

NORME EUROPÉENNE

EUROPÄISCHE NORM

October 2021

ICS 91.060.20

Supersedes EN 508-3:2008

English Version

Roofing and cladding products from metal sheet - Specification for self-supporting products of steel, aluminium or stainless steel sheet - Part 3: Stainless steel

Produits de couverture et bardage en tôle métallique -
Spécification pour les produits autoportants en tôle
d'acier, d'aluminium ou d'acier inoxydable - Partie 3 :
Acier inoxydable

Dachdeckungs- und Wandbekleidungs-elemente aus
Metallblech - Spezifikation für selbsttragende
Dachdeckungsprodukte aus Stahlblech,
Aluminiumblech oder nichtrostende Stahlblech - Teil 3:
Nichtrostender Stahlblech

This European Standard was approved by CEN on 11 July 2021.

CEN members are bound to comply with the CEN/CENELEC Internal Regulations which stipulate the conditions for giving this European Standard the status of a national standard without any alteration. Up-to-date lists and bibliographical references concerning such national standards may be obtained on application to the CEN-CENELEC Management Centre or to any CEN member.

(standards.iteh.ai)

This European Standard exists in three official versions (English, French, German). A version in any other language made by translation under the responsibility of a CEN member into its own language and notified to the CEN-CENELEC Management Centre has the same status as the official versions.

<https://standards.iteh.ai/catalog/standards/sist/8b2fd23b-db42-4d37-baa5->

CEN members are the national standards bodies of Austria, Belgium, Bulgaria, Croatia, Cyprus, Czech Republic, Denmark, Estonia, Finland, France, Germany, Greece, Hungary, Iceland, Ireland, Italy, Latvia, Lithuania, Luxembourg, Malta, Netherlands, Norway, Poland, Portugal, Republic of North Macedonia, Romania, Serbia, Slovakia, Slovenia, Spain, Sweden, Switzerland, Turkey and United Kingdom.



EUROPEAN COMMITTEE FOR STANDARDIZATION
COMITÉ EUROPÉEN DE NORMALISATION
EUROPÄISCHES KOMITEE FÜR NORMUNG

CEN-CENELEC Management Centre: Rue de la Science 23, B-1040 Brussels

Contents	Page
European foreword.....	3
Introduction	4
1 Scope.....	5
2 Normative references.....	5
3 Terms and definitions, symbols and abbreviations	6
3.1 General.....	6
3.2 Materials.....	6
3.3 Profile definitions	7
3.4 Geometry.....	9
3.5 Symbols and abbreviations	12
4 Requirements	12
4.1 General.....	12
4.2 Materials.....	12
4.2.1 Grades.....	12
4.2.2 Chemical composition	13
4.2.3 Physical properties.....	13
4.2.4 Surface finishes of stainless steel.....	13
4.2.5 Tin coated stainless steel	13
4.2.6 Organic coated stainless steel	14
4.3 Products.....	14
4.3.1 Mechanical resistance	14
4.3.2 Design (calculation and tests) of mechanical resistance.....	14
4.3.3 Dimensions.....	15
4.3.4 Dimensional tolerances for the profiled sheets.....	15
4.3.5 Safety in case of fire.....	15
5 Test methods	16
5.1 Material properties	16
5.2 Mechanical properties.....	16
6 Designation.....	16
7 Marking, labelling, packaging.....	16
7.1 Marking and labelling.....	16
7.2 Packaging and special ordering conditions.....	17
7.3 Transport, storage and handling.....	17
Annex A (informative) Physical properties	18
Annex B (normative) Dimensional tolerances	19
Annex C (informative) Test methods for concentrated load	39
Bibliography.....	40

European foreword

This document (EN 508-3:2021) has been prepared by Technical Committee CEN/TC 128 “Roof covering products for discontinuous laying and products for wall cladding”, the secretariat of which is held by NBN.

This European Standard shall be given the status of a national standard, either by publication of an identical text or by endorsement, at the latest by April 2022, and conflicting national standards shall be withdrawn at the latest by April 2022.

Attention is drawn to the possibility that some of the elements of this document may be the subject of patent rights. CEN shall not be held responsible for identifying any or all such patent rights.

This document supersedes EN 508-3:2008.

In comparison with EN 508-3:2008, the following technical changes have been made:

- scope of the document has been extended to cladding products;
- grades have been added;
- clarification has been done about tolerances of liner trays.

These changes or additions can be found in the following clauses and subclauses: Clause 1; Clause 2; 3.2.3; 4.2.1; 4.2.4; 4.3.5; 4.3.5.2; 4.3.5.3; Annex A and the Bibliography.

EN 508, *Roofing and cladding products from metal sheet — Specification for self-supporting products of steel, aluminium or stainless steel sheet*, consists of the following parts:

- Part 1: Steel; <https://standards.iteh.ai/catalog/standards/sist/8b2fd23b-db42-4d37-baa5-1abd0db4cbac/sist-en-508-3-2021>
- Part 2: Aluminium;
- Part 3: Stainless steel.

Any feedback and questions on this document should be directed to the users' national standards body. A complete listing of these bodies can be found on the CEN website.

According to the CEN-CENELEC Internal Regulations, the national standards organisations of the following countries are bound to implement this European Standard: Austria, Belgium, Bulgaria, Croatia, Cyprus, Czech Republic, Denmark, Estonia, Finland, France, Germany, Greece, Hungary, Iceland, Ireland, Italy, Latvia, Lithuania, Luxembourg, Malta, Netherlands, Norway, Poland, Portugal, Republic of North Macedonia, Romania, Serbia, Slovakia, Slovenia, Spain, Sweden, Switzerland, Turkey and the United Kingdom.

Introduction

Figure 1 indicates the position of this document in the CEN framework of standards concerning roofing products of metal sheet.

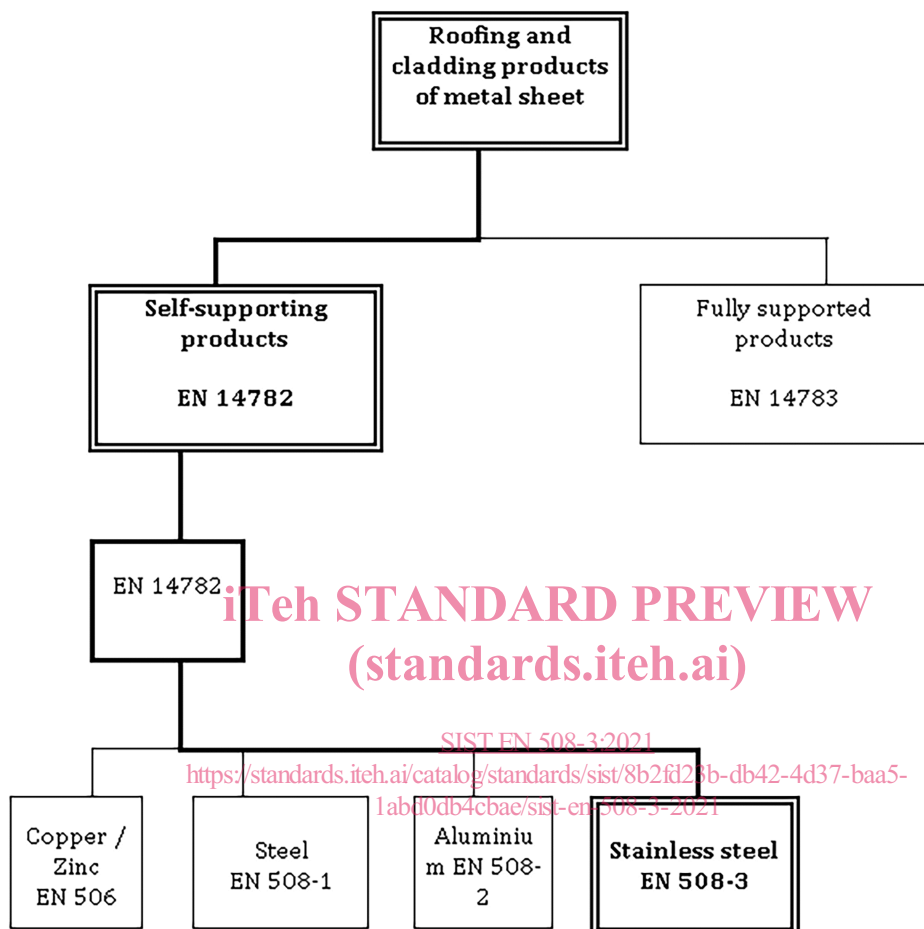

Figure 1 — Framework of standards

In this document the performance of the product has been defined in terms of calculation and a number of type tests.

The performance of a roof or cladding constructed with these products depends not only on the properties of the product as required by this document, but also on the design, construction and performance of the roof or cladding as a whole in relation to the environment and conditions of use.

1 Scope

This part of EN 508 specifies requirements for self-supporting products for roof covering, wall cladding, lining, liner tray and tile products for discontinuous laying made from stainless steel sheets with or without additional metallic and/or organic coatings. Sheets intended to be used with insulation and membranes are also covered.

This document establishes general characteristics, definitions, classifications and labelling for the products, together with requirements for the materials from which the products can be manufactured. It is intended to be used either by manufacturers to ensure that their products comply with the requirements or by purchasers to verify that the products comply before they are dispatched from the factory. It specifies the requirements for products which enable them to meet all normal service conditions.

This document applies to all discontinuously laid self-supporting external profiled sheets for roof covering, wall cladding, lining, liner trays and tile products with the exception of tiles with a surface area less than 1 m² and produced by stamping. These profiled roof sheets are designed to keep wind, rain and snow out of the building and to transfer any resultant loads and infrequent maintenance loads to the structure.

This document does not cover products for structural purposes, i.e. it does cover products used in structural class III (according to EN 1993-1-3), it does not cover products used in constructions of structural classes I and II (according to EN 1993-1-3) intended to contribute to the global or partial stability of the building structure by providing racking resistance or resistance to permanent static loads (excluding self-weight of the metal sheet).

No requirements for supporting construction, design of roof or cladding, lining, tile system and execution of connections and flashings are included.

2 Normative references

[SIST EN 508-3:2021](https://standards.iteh.ai/catalog/standards/sist/8b2fd23b-db42-4d37-baa5-1abd0db4c8ae/sist-en-508-3-2021)

[https://standards.iteh.ai/catalog/standards/sist/8b2fd23b-db42-4d37-baa5-](https://standards.iteh.ai/catalog/standards/sist/8b2fd23b-db42-4d37-baa5-1abd0db4c8ae/sist-en-508-3-2021)

[1abd0db4c8ae/sist-en-508-3-2021](https://standards.iteh.ai/catalog/standards/sist/8b2fd23b-db42-4d37-baa5-1abd0db4c8ae/sist-en-508-3-2021)

The following documents are referred to in the text in such a way that some or all of their content constitutes requirements of this document. For dated references, only the edition cited applies. For undated references, the latest edition of the referenced document (including any amendments) applies.

EN 10088-1, *Stainless steels - Part 1: List of stainless steels*

EN 10088-4, *Stainless steels - Part 4: Technical delivery conditions for sheet/plate and strip of corrosion resisting steels for construction purposes*

EN 14782, *Self-supporting metal sheet for roofing, external cladding and internal lining - Product specification and requirements*

EN ISO 9445-1, *Continuously cold-rolled stainless steel - Tolerances on dimensions and form - Part 1: Narrow strip and cut lengths (ISO 9445-1)*

EN ISO 9445-2, *Continuously cold-rolled stainless steel - Tolerances on dimensions and form - Part 2: Wide strip and plate/sheet (ISO 9445-2)*

EN 508-3:2021 (E)**3 Terms and definitions, symbols and abbreviations**

For the purposes of this document, the following terms and definitions apply.

ISO and IEC maintain terminological databases for use in standardization at the following addresses:

- ISO Online browsing platform: available at <https://www.iso.org/obp>
- IEC Electropedia: available at <https://www.electropedia.org/>

3.1 General**3.1.1****self-supporting product**

product which will, by virtue of its material and shape, support all applied loadings (e.g. snow, wind, foot traffic) and transmit these loadings to spaced structural supports

3.2 Materials**3.2.1****stainless steel sheet**

steel sheet with at least a content of 10,5 % chromium and max. 1,2 % carbon

Note 1 to entry: For roofing or cladding products the stainless steel grades are:

- ferritic;
 - austenitic with or without molybdenum;
 - austenitic ferritic (duplex); and
 - higher alloyed grades.
- [SIST EN 508-3:2021
https://standards.iteh.ai/catalog/standards/sist/8b2fd23b-db42-4d37-baa5-1abd0db4cbac/sist-en-508-3-2021](https://standards.iteh.ai/catalog/standards/sist/8b2fd23b-db42-4d37-baa5-1abd0db4cbac/sist-en-508-3-2021)

3.2.2**tin coated stainless steel**

stainless steel continuously coated with tin by electrodeposition

3.2.3**organic coated stainless steel**

stainless steel or tin coated stainless steel which is continuously (factory-) painted by roller or spray process

Note 1 to entry: EN 10169:—² refers to this type of coated steel.

3.3 Profile definitions

3.3.1

trapezoidal profiled sheet

self-supporting sheet which is designed to allow it to be side and end lapped, the crowns of which may be rounded and, in addition, the crowns, webs and valleys may be stiffened

Note 1 to entry: See Figures 2, 3, 4 and 5.

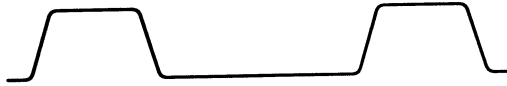

Figure 2 — Part of typical trapezoidal profile

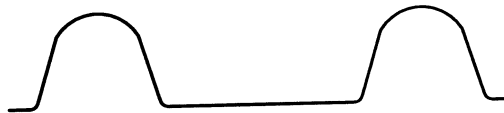

Figure 3 — Part of typical trapezoidal profile with rounded crowns



Figure 4 — Part of typical trapezoidal profile with stiffened crown and web



Figure 5 — Part of typical trapezoidal profile with stiffened valley

EN 508-3:2021 (E)

3.3.2

sinusoidal profiled sheet

self-supporting sheet which is designed to allow it to be side and end lapped, comprising a series of arc shaped crowns and valleys interconnected with tangential webs

Note 1 to entry: See Figure 6.

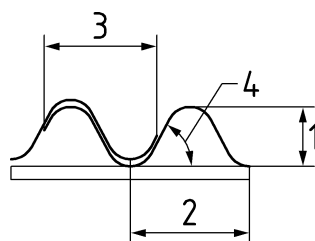
**Key**

1	depth	3	overlap
2	pitch	4	angle

Figure 6 — Part of typical sinusoidal profiled sheet

3.3.3

standing seam sheet**concealed fix sheet**

self-supporting sheet profiled in such a way that the fixings are hidden within the construction and are not exposed to the weather

Note 1 to entry: The profile shape is designed to allow the formation of side laps on site.

Note 2 to entry: As these types of roof covering products are used in proprietary roofing systems, no structural requirements are given within this document.

Note 3 to entry: See Figures 7 and 8.

Note 4 to entry: These products are normally designed by testing.



Figure 7 — Typical standing seam profile

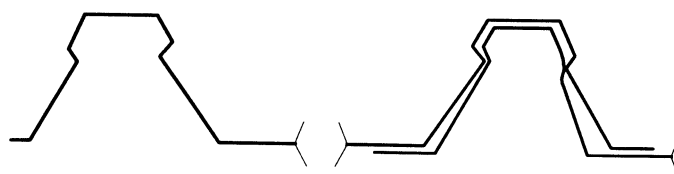

Figure 8 — Typical concealed fix profile

3.3.4 tile profile

part of typical tile profiled sheets that can allow the sheet to be side and/or end lapped

Note 1 to entry: The tile profiles can include transverse steps.

Note 2 to entry: As these types of roof covering products are used in proprietary systems, no structural requirements are given within this document.

Note 3 to entry: See Figure 9 a), b) and c).

Note 4 to entry: These products are normally designed by testing.

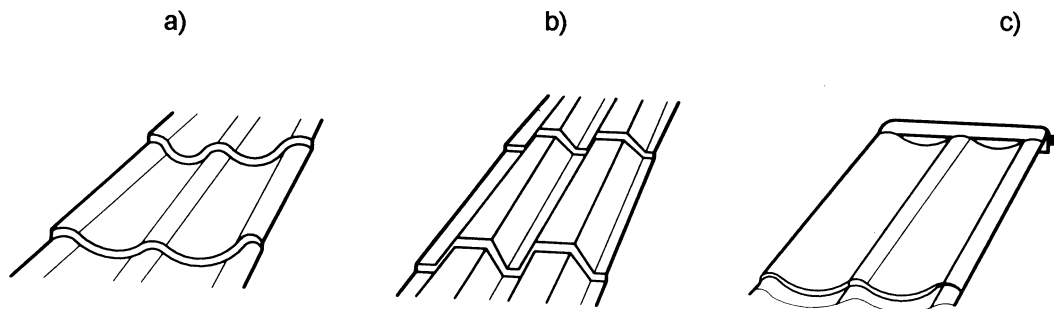
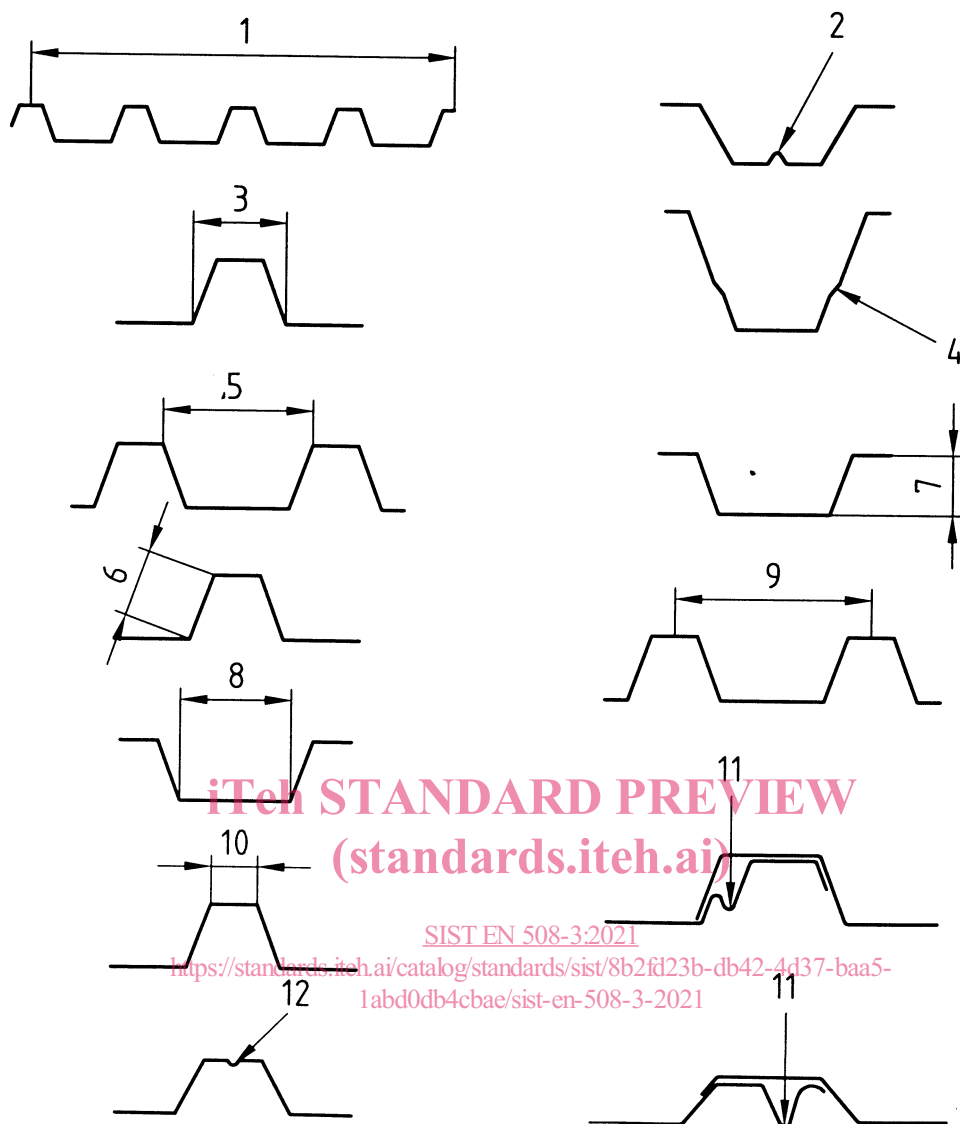

Figure 9 — Typical tile profiles
(standards.iteh.ai)

3.4 Geometry

SIST EN 508-3:2021

Note 1 to entry: The names for various parts of typical trapezoidal profiled sheets are given in Figures 10 and 11, with additional definitions for sinusoidal profiles in Figure 6 and tile profiles in Figure 12.

**Key**

1	cover width	7	depth
2	valley stiffener	8	valley
3	rib	9	pitch
4	web stiffener	10	crown
5	trough	11	drainage groove
6	web	12	crown stiffener

Figure 10 — Definitions of the parts of typical trapezoidal profiled sheets

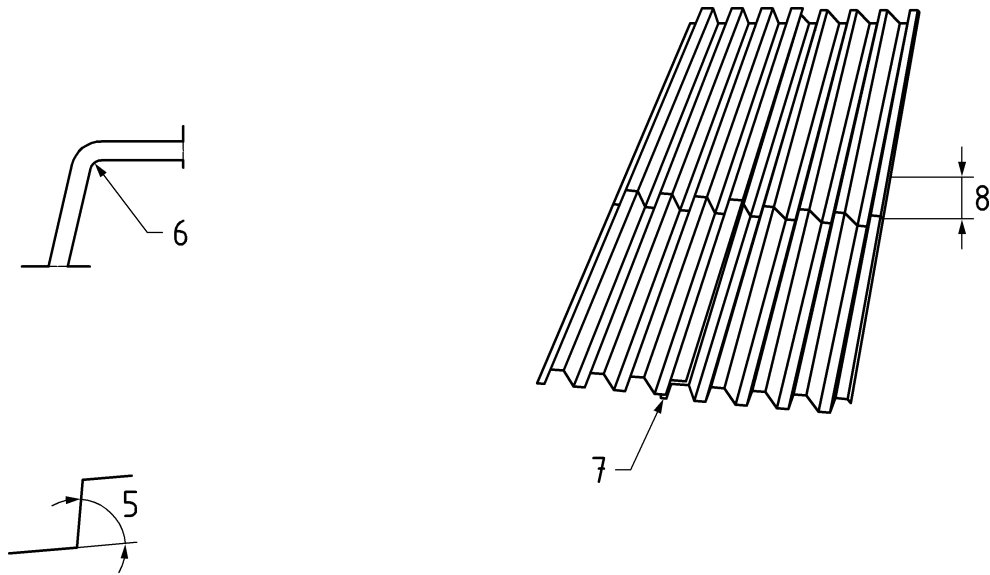

iTeh STANDARD PREVIEW
(standards.iteh.ai)

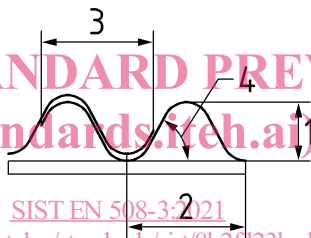

SIST EN 508-3:2021
<https://standards.iteh.ai/catalog/standards/sist/8b2fd23b-db42-4d37-baa5-1abd0db4cbac/sist-en-508-3-2021>

Key

- 1 bend radius
- 2 end lap
- 3 web angle
- 4 overlap
- 5 underlap
- 6 side lap in principle the same on tiles

Figure 11 — Definitions of the parts of typical trapezoidal profiled sheets

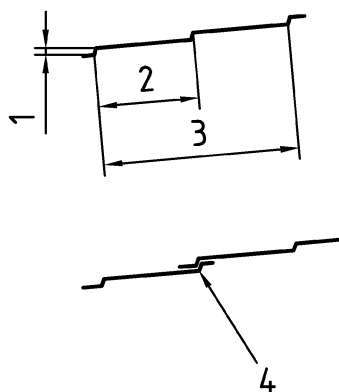

Key

- 1 height of the step
- 2 length of the step
- 3 number of steps
- 4 end lap

Figure 12 — Definitions of the parts of typical tile