



Designation: F1004 – 09

Standard Consumer Safety Specification for Expansion Gates and Expandable Enclosures¹

This standard is issued under the fixed designation F1004; the number immediately following the designation indicates the year of original adoption or, in the case of revision, the year of last revision. A number in parentheses indicates the year of last reapproval. A superscript epsilon (ϵ) indicates an editorial change since the last revision or reapproval.

INTRODUCTION

This consumer safety specification addresses incidents of head and neck entrapment in children's expansion gates and expandable enclosures. It also addresses the ability of a pressure gate to resist a push-out force.

The U.S. Consumer Product Safety Commission (CPSC) identified incidents that generally involved a child's head or neck, or both, becoming entrapped in diamond shaped openings and strangulation of children in V-shapes at the top of accordion style expansion gates or expandable enclosures. Additional incidents and injuries were identified that involved children attempting to climb up and over expansion gates and expandable enclosures, and pushing or pulling pressure gates out of doorways.

This consumer safety specification is written within the current state-of-the-art of gate and enclosure technology. It is intended that this consumer safety specification will be updated whenever substantive information becomes available, which necessitates additional requirements or justifies the revision of existing requirements.

This specification does not address incidents in which gates or enclosures are blatantly misused although warnings and safety instructions are required to be displayed prominently on and with each gate or enclosure.

1. Scope

1.1 This consumer safety specification covers minimum safety performance requirements, test methods, and requirements for labeling and instructional material to minimize hazards to young children resulting from the normal use and reasonably foreseeable misuse and abuse of expansion gates and expandable enclosures.

1.2 Products known as expansion gates and expandable enclosures, or by any other name, which are in the scope of this consumer safety specification are intended for young children aged six months through 24 months, and are defined in Section 3.

1.3 Expansion gates and expandable enclosures defined in Section 3 are for domestic use and are not to be confused with other types of gates or enclosures that may be specifically designed for commercial, institutional, agricultural, pet use, or any other such use.

1.4 No expansion gate or expandable enclosure as defined in Section 3, that is, produced after the approval date of this

consumer safety specification either by label or other means, shall indicate compliance with this specification unless it conforms to all the requirements contained herein.

1.5 For expediency, expansion gates and expandable enclosures as defined in Section 3 will heretofore be referred to in this consumer safety specification as "gates" and "enclosures" unless referred to definitively.

1.6 The values stated in inch-pound units are to be regarded as standard. The values given in parentheses are mathematical conversions to SI units that are provided for information only and are not considered standard.

1.7 The following pertains only to the test methods portion, Section 7, of this specification. *This standard does not purport to address all of the safety concerns, if any, associated with its use. It is the responsibility of the user of this standard to establish appropriate safety and health practices and determine the applicability of regulatory limitations prior to use.*

2. Referenced Documents

2.1 *ASTM Standards*:²
[D3359 Test Methods for Measuring Adhesion by Tape Test](#)

¹ This consumer safety specification is under the jurisdiction of ASTM Committee F15 on Consumer Products and is the direct responsibility of Subcommittee F15.16 on Highchairs, Hook-On Chairs and Expandable Gates.

Current edition approved July 1, 2009. Published August 2009. Originally approved in 1986. Last previous edition approved in 2007 as F1004 – 07. DOI: 10.1520/F1004-09.

² For referenced ASTM standards, visit the ASTM website, www.astm.org, or contact ASTM Customer Service at service@astm.org. For *Annual Book of ASTM Standards* volume information, refer to the standard's Document Summary page on the ASTM website.

F406 Consumer Safety Specification for Non-Full-Size Baby Cribs/Play Yards

2.2 *British Standard*.³

BS 4125 Specification for Safety Requirements for Child Safety Barriers for Domestic Use

2.3 *Federal Regulations*.⁴

16 CFR 1303 Ban of Lead-Containing Paint and Certain Consumer Products Bearing Lead Containing Paint

16 CFR 1500 Hazardous Substances Act Regulations, Including Parts:

16 CFR 1500.48 Technical Requirements for Determining a Sharp Point in Toys and Other Articles Intended for Use by Children Under Eight Years of Age

16 CFR 1500.49 Technical Requirements for Determining a Sharp Metal or Glass Edge in Toys and Other Articles Intended for Use by Children Under Eight-Years of Age

16 CFR 1501 Method for Identifying Toys and Other Articles Intended for Use by Children Under Three Years of Age Which Present Choking, Aspiration, or Ingestion Hazards Because of Small Parts

3. Terminology

3.1 *Definitions of Terms Specific to This Standard*:

3.1.1 *completely-bounded opening, n*—any opening in the main structure of a product that is enclosed totally by boundaries on all sides.

3.1.2 *conspicuous, adj*—label which is visible, when the gate/expandable enclosure is in a manufacturer's recommended use position, to a person standing near the gate/expandable enclosure at any one position around the gate/expandable enclosure, but not necessarily visible from all positions.

3.1.3 *double-action locking mechanism, n*—locking mechanism that requires two distinct and separate actions in a single lock to activate the release mechanism.

3.1.4 *expandable enclosures, n*—self-supporting barrier intended to completely surround an area or play-space within which a young child (see 1.2) may be confined. Enclosures may be marketed for indoor or outdoor use, or both.

3.1.5 *expansion gate, n*—barrier intended to be erected in an opening, such as a doorway, to prevent the passage of young children (see 1.2), but which can be removed by older persons who are able to operate the locking mechanism. Such gates are available in a number of different styles of construction and are manufactured from a variety of different materials.

3.1.6 *manufacturer's recommended use position(s)*—any position to prevent passage of a child which the manufacturer represents as a normal, allowable or acceptable configuration. This specifically excludes positions, which the manufacturer shows in a like manner in its literature to be unacceptable, unsafe or not recommended.

3.1.7 *nonpaper label, n*—any label material, such as plastic or metal, which either will not tear without the aid of tools or tears leaving a sharply-defined edge.

3.1.8 *paper label, n*—any label material, which tears without the aid of tools and leaves a fibrous edge.

3.1.9 *partially-bounded opening, n*—any opening in the main structure of a product that is not enclosed totally by boundaries on all sides. For example, a V-shape in the top of an accordion slat-style product or a rectangular notch resulting from a gap between a wall surface and the main structure of a baby gate would be considered a partially-bounded opening.

3.1.10 *static load, n*—vertically downward force applied by a calibrated force gage or by dead weights.

4. Calibration and Standardization

4.1 All testing shall be conducted on a concrete floor which may be covered with 1/8-in. (3-mm) thick vinyl floor cover, unless the test instructs differently.

4.2 The gate/expandable enclosure shall be completely assembled, unless otherwise noted, in accordance with the manufacturer's instructions.

4.3 No testing shall be conducted within 48 h of manufacturing.

4.4 The product to be tested shall be preconditioned in a room with an ambient temperature of $73 \pm 9^\circ\text{F}$ ($23 \pm 5^\circ\text{C}$) for at least 1 h prior to testing. Testing then shall be conducted within this temperature range.

4.5 All testing required by this specification shall be conducted on the same unit.

5. General Requirements

5.1 *Wood Parts*—Prior to testing, any exposed wood parts shall be smooth and free from splinters.

5.2 Screws shall not be used in the assembly of any components or locking or attaching device (or devices) that are intended to be removed by the consumer during daily operations.

5.3 There shall be no hazardous sharp edges or points as defined by 16 CFR 1500.48 and 16 CFR 1500.49 before or after testing to this consumer safety specification.

5.4 There shall be no small parts as defined by 16 CFR 1501 before testing or liberated as a result of testing to this specification.

5.5 *Latching or Locking Mechanisms*—Any unit that folds, or has a moveable panel, shall have a latching or locking device or other provision in the design that will prevent the unit from unintentionally folding when properly placed in the manufacturer's recommended use position. The unit shall remain in its manufacturer's recommended use position during and upon completion of the test, described at 7.1. If a unit is designed with a latching or locking device in order to prevent folding or to keep the unit in the closed position, that device shall remain engaged and operative after testing.

5.6 *Openings*—Holes or slots that extend entirely through a wall section of any rigid material less than 0.375 in. (9.53 mm) thick and admit a 0.210-in. (5.33-mm) diameter rod shall also admit a 0.375-in. (9.53-mm) diameter rod. Holes or slots that are between 0.210 in. (5.33 mm) and 0.375 in. (9.53 mm) and have a wall thickness less than 0.375 in. (9.53 mm) but are limited in depth to 0.375 in. (9.53 mm) maximum by another rigid surface shall be permissible (see Fig. 1). The product shall be evaluated in all manufacturer's recommended positions.

³ Available from British Standards Institute (BSI), 389 Chiswick High Rd., London W4 4AL, U.K.

⁴ Code of Federal Regulations is available from the Superintendent of Documents, Government Printing Office, Washington, DC 21402.

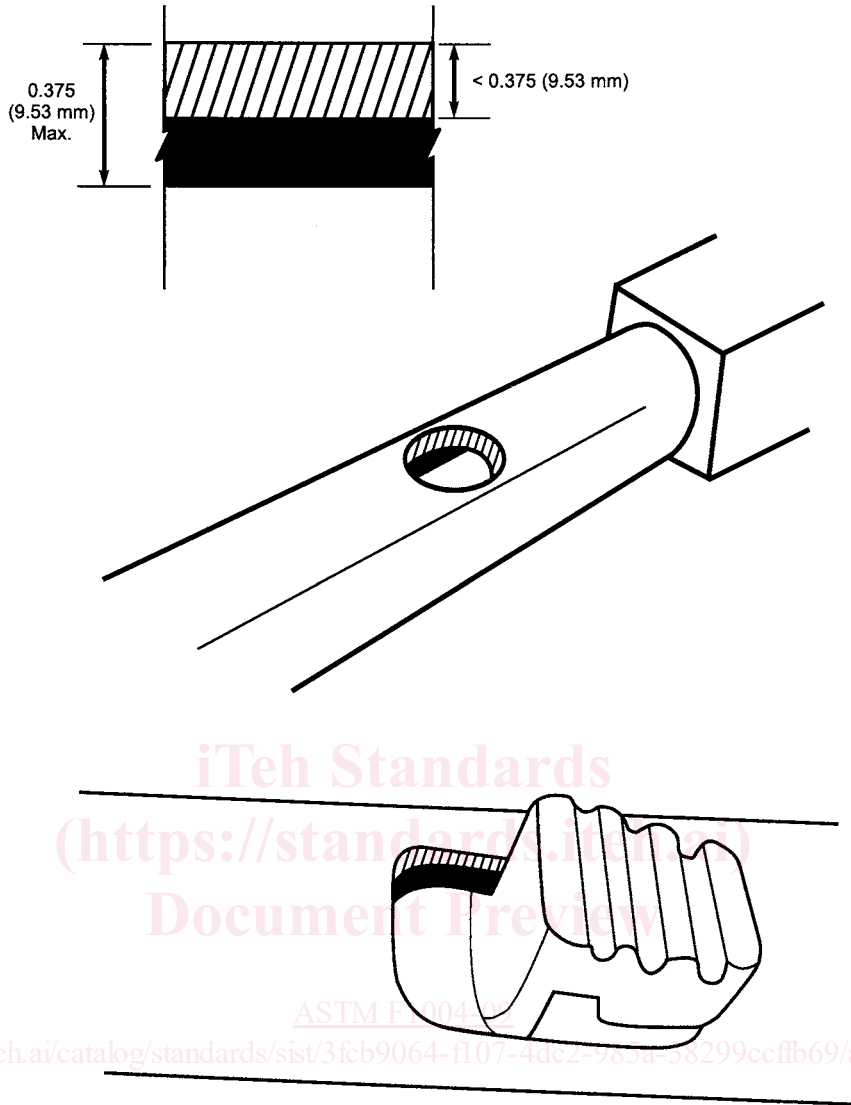

FIG. 1 Openings

5.6.1 Openings through multiple wall sections and openings created by multiple wall sections must meet the size requirements in 5.6 if the total thickness of the combined wall sections and any air gap between the wall sections is less than 0.375 in. (9.53 mm).

5.7 *Exposed Coil Springs*—Any exposed coil spring, which is accessible to the occupant having or capable of generating a space between coils of 0.210 in. (5.33 mm) or greater during static load testing in accordance with 7.1 shall be covered or otherwise designed to prevent injury from entrapment.

5.8 *Scissoring, Shearing, and Pinching*—The gate/expandable enclosure when in the manufacturer’s recommended use position(s) shall be designed and constructed to prevent injury to the child from any scissoring, shearing, or pinching when members or components rotate about a common axis or fastening point, slide, pivot, fold, or otherwise move relative to one another. Scissoring, shearing, or pinching that may cause injury shall not be permissible when the edges of

any rigid parts admit a probe greater than 0.210 in. (5.33 mm) and less than 0.375 in. (9.53 mm) diameter at any accessible point through the range of motion of such parts.

5.9 *Labeling*:

5.9.1 Warning labels (whether paper or nonpaper) shall be permanent when tested in accordance with 7.6.1-7.6.3.

5.9.2 Warning statements applied directly onto the surface of the product by hot stamping, heat transfer, printing, wood burning, etc., shall be permanent when tested in accordance with 7.6.4.

5.9.3 Nonpaper labels shall not liberate small parts when tested in accordance with 7.6.5.

5.10 *Push-Out Test*:

5.10.1 All gates shall be tested in accordance with 7.7. At each test location, the average push-out force shall be a minimum of 10 lbf (45 N).

5.10.2 Gates that are marketed as being usable at the top of stairs shall be tested in accordance with 7.7. At each test

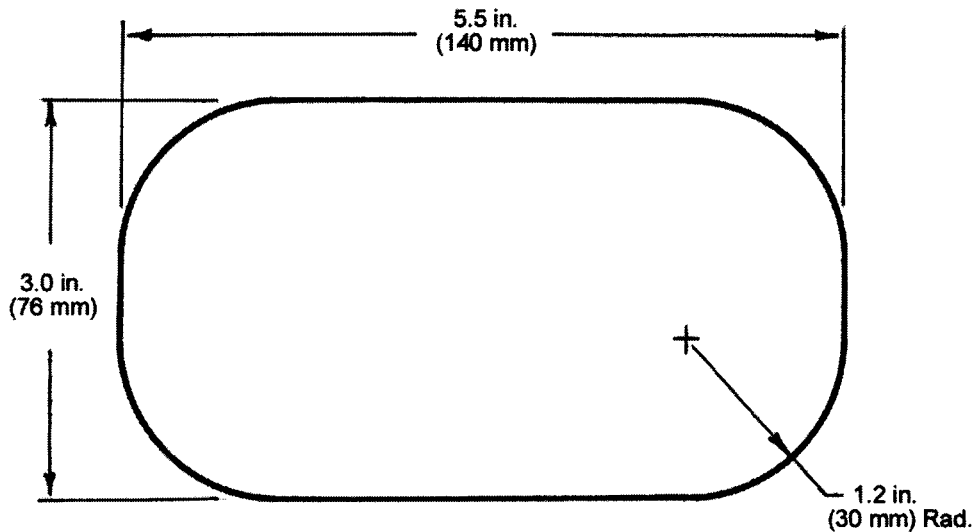

Template to be constructed of smooth rigid material not less than 1/8 in. (3 mm) thick

NOTE—Small Torso Template A is to be constructed of smooth rigid material not less than 1/8 in. (3.18 mm) thick.

FIG. 2 Small Torso Template A

location, the average push-out force shall exceed 30 lbf (133 N). In addition, each individual force shall exceed 20 lbf (89 N). Gates that do not meet the test requirements in 8.5.5 shall bear a warning that they shall not be used at the top of stairs.

5.11 The paint and surface coating on the product shall comply with 16 CFR 1303.

6. Performance Requirements

6.1 The following performance requirements apply to gates and enclosures when they are erected or installed in the manufacturer's recommended use position.

6.1.1 *Completely-Bounded Openings*—Openings shall not permit the passage of the Small Torso Template A (see Fig. 2) when tested in accordance with 7.3

6.1.2 *Height of Sides*—The vertical distance from the floor to the lowest point of the uppermost surface shall not be less than 22 in. (560 mm) when measured from the floor.

6.1.3 *Vertical Strength*—Top rails, slats, and framing components of the gates or enclosures shall be tested in accordance with 7.1 and shall not fracture, disengage, fold, or have a permanent deflection that reduces the lowest point of the uppermost surface of a gate or enclosure (see 6.1.2) to a dimension of less than 22 in. (560 mm) when measured vertically from the floor.

6.1.4 *Bottom Spacing*—The vertical distance from the floor to the highest point of the lowermost surface of the unit shall not permit the passage of the Small Torso Template A (see Fig. 2) as tested in accordance with 7.3.

6.1.5 *Configuration of Uppermost Edge*—A partially bounded opening at any point in the uppermost edge of a product that is greater than 1.5 in (38 mm) in width and more than 0.64 in. (16.2 mm) in depth shall be subjected to the test procedure in 7.4 (see Fig. 3). During the test, no portions of the boundaries of the opening shall simultaneously contact more than one of surfaces "B," "C," or corner "BC" or "CC" in any

combination if they are not opposing sides of the center line of Test Template B (see Fig. 4).

6.1.6 *Protective Components*—If a child can grasp protective components, such as caps, sleeves, or plugs used for protection from sharp edges, points, or entrapment of fingers or toes, between the thumb and forefinger, or teeth, or if there is at least a 0.040 in. (1.00 mm) gap between the component and its adjacent parent component, such components shall not be removed when tested in accordance with 7.5.

7. Test Methods

7.1 Vertical Strength (6.1.3 and 5.5):

7.1.1 *Gates*—Adjust the gate to the maximum opening width recommended by the manufacturer. Apply a static load of 45 lbf (200 N) vertically downward five times to each of the top points of the gate (or on center for gates with horizontal top rail). The force shall be applied through a 2 by 2 by 3/4 in. (50 by 50 by 19 mm) wood block. Gradually apply the force within 5 s and maintain for an additional 10 s, with approximately 5 s intervals between applications. Repeat the test with the gate adjusted to the minimum opening width recommended by the manufacturer.

7.1.2 *Enclosures*—The same loading procedure as specified in 7.1.1 is applicable but shall be applied to every other top joint. If the joints are different, apply load to the joints, which are more likely to result in a nonconformance as defined in 5.3.

7.2 Locking Mechanism Test:

For foot pedal actuated gates, apply a force of 35 lbf (156 N) in the direction tending to unlock it. The force shall be applied to the foot pedal through a 2 by 2 by 3/4-in. (50 by 50 by 19-mm) wooden block. Gradually apply the force within 5 s and maintain for an additional 10 s.

7.3 *Size of Completely-Bounded Openings (6.1.1 and 6.1.4)*—The size of any completely-bounded opening shall not permit passage of Small Torso Template A (see Fig. 2) when

Partially-bounded opening presents potential risk of head/neck entrapment

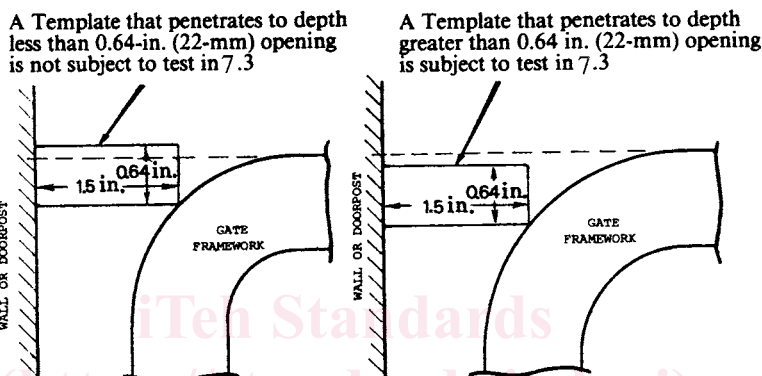
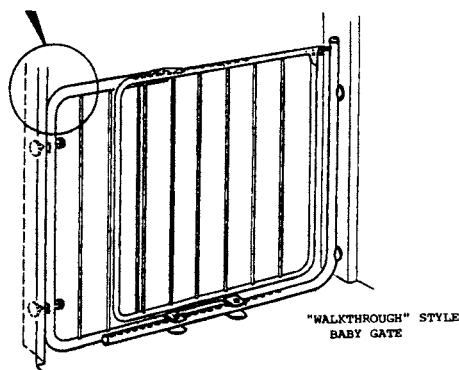

NOTE—Use a rectangular template to determine when a partially-bounded opening must be tested with Test Template B in accordance with 7.4.

FIG. 3 Walk-Through Style Baby Gate and Walls or Doorposts

the template is rotated to any orientation about its own axis and parallel to the plane of the opening (see Figs. 1 and 5).

7.4 Partially-Bounded Openings at the Uppermost Edge (6.1.5):

7.4.1 Place Test Template B (see Fig. 4) vertically downward into the opening with its center line vertical and the plane of the template parallel to the plane of the opening, until downward motion is arrested by contact between the test template and the boundaries of the opening. By visual inspection, determine if there is simultaneous contact between more than one of surfaces “B” or “C,” or corners “BC” or “CC,” in any combination, that are on opposite sides of the template center line.

7.4.2 If the opening conforms to the requirements, but is not symmetrical about a vertical centerline, perform the following additional test:

7.4.2.1 Rock the template sideways (parallel to the plane of the opening), while maintaining contact between the boundary of the opening and surface “A” or corners “AB,” or both. The rocking motion shall be terminated when there is either contact between a boundary of the opening and a surface or corner of the template other than surface “A” or corners “AB,” or until surface “B” attains a vertical orientation. Again, visually determine if there is simultaneous contact between more than one of surfaces “B” or “C,” or corners “BC” or “CC,” in any

combination, that are on opposite sides of the template center line. If such contact occurs, the opening fails to conform to the requirement.

7.4.3 If a product contains any partially-bounded openings, which change their configuration if the product is erected to less than the maximum dimension claimed by the manufacturer, the test for conformance shall be repeated at the minimum dimension and, at the discretion of the test personnel, at any dimension between the claimed minimum and maximum.

7.4.4 For any product in which the uppermost edge is a nonrigid member, the visual inspection for conformance to the requirement shall be performed when a force of 30 lbf (134 N) is applied vertically downwards to Test Template B (see Fig. 4).

7.5 Removal of Protective Components (6.1.6):

7.5.1 Components shall be tested in accordance with each of the following methods in the sequence listed.

7.5.2 Securely affix the gate/expandable enclosure so that it cannot move during performance of the following tests.

7.5.3 Tension Test—Attach a force gauge to the component (cap, sleeve, or plug) by means of any suitable device. A clamp, such as shown in Fig. 6 may be a suitable device for components that cannot reasonably be expected to be grasped by a child’s fingers on their outer diameter but which have a gap of 0.040 in. (1.00 mm) or more between the rear face of the

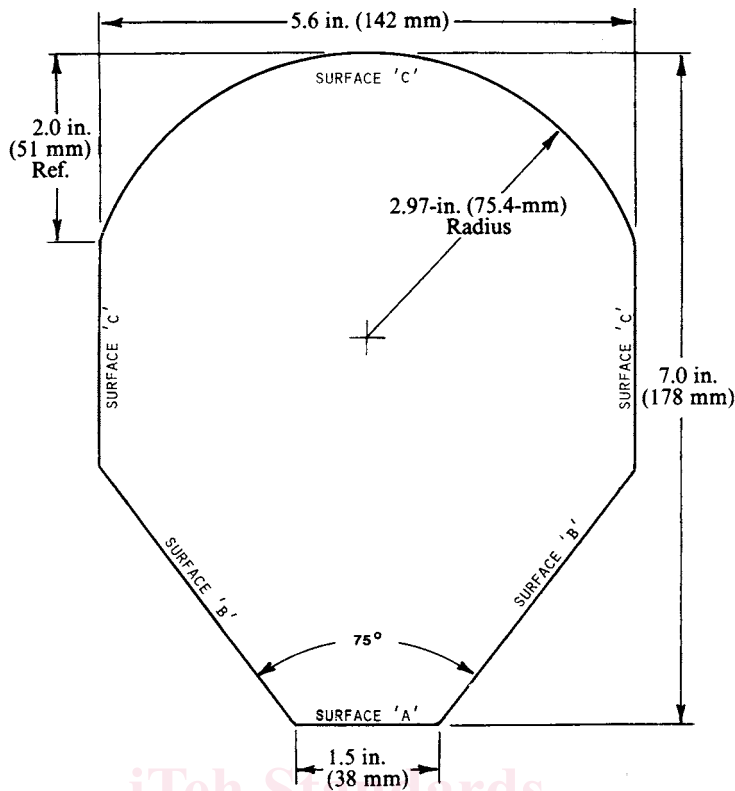

NOTE—Test Template B is to be constructed of smooth rigid material not less than 1/8 in. (3.18 mm) thick.

FIG. 4 Test Template B

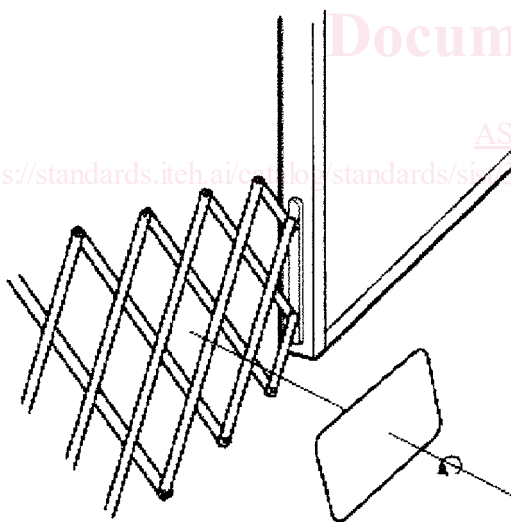

FIG. 5 Orientation for Small Torso Template A

15 lbf (67N) MAX TENSION

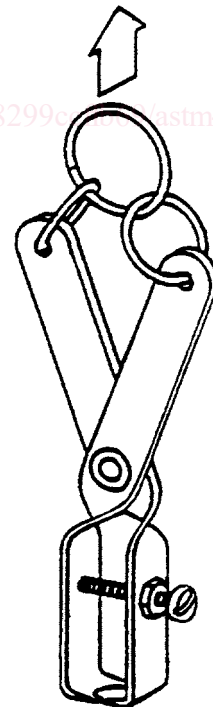

FIG. 6 Tension Test Adapter/Clamp

component and the structural member of the gate/expandable enclosure to which they are attached.

7.5.3.1 The attachment device shall not compress or expand the component so that it hinders any possible removal.

7.5.3.2 Apply force on the scale in a direction that normally would be associated with the removal of the protective component.