



Designation: E 1921 – 09b

Standard Test Method for Determination of Reference Temperature, T_o , for Ferritic Steels in the Transition Range¹

This standard is issued under the fixed designation E 1921; the number immediately following the designation indicates the year of original adoption or, in the case of revision, the year of last revision. A number in parentheses indicates the year of last reapproval. A superscript epsilon (ϵ) indicates an editorial change since the last revision or reapproval.

1. Scope

1.1 This test method covers the determination of a reference temperature, T_o , which characterizes the fracture toughness of ferritic steels that experience onset of cleavage cracking at elastic, or elastic-plastic K_{Jc} instabilities, or both. The specific types of ferritic steels (3.2.1) covered are those with yield strengths ranging from 275 to 825 MPa (40 to 120 ksi) and weld metals, after stress-relief annealing, that have 10 % or less strength mismatch relative to that of the base metal.

1.2 The specimens covered are fatigue precracked single-edge notched bend bars, SE(B), and standard or disk-shaped compact tension specimens, C(T) or DC(T). A range of specimen sizes with proportional dimensions is recommended. The dimension on which the proportionality is based is specimen thickness.

1.3 Median K_{Jc} values tend to vary with the specimen type at a given test temperature, presumably due to constraint differences among the allowable test specimens in 1.2. The degree of K_{Jc} variability among specimen types is analytically predicted to be a function of the material flow properties (1)² and decreases with increasing strain hardening capacity for a given yield strength material. This K_{Jc} dependency ultimately leads to discrepancies in calculated T_o values as a function of specimen type for the same material. T_o values obtained from C(T) specimens are expected to be higher than T_o values obtained from SE(B) specimens. Best estimate comparisons of several materials indicate that the average difference between C(T) and SE(B)-derived T_o values is approximately 10°C (2). C(T) and SE(B) T_o differences up to 15°C have also been recorded (3). However, comparisons of individual, small datasets may not necessarily reveal this average trend. Datasets which contain both C(T) and SE(B) specimens may generate T_o results which fall between the T_o values calculated using solely C(T) or SE(B) specimens. It is therefore strongly

recommended that the specimen type be reported along with the derived T_o value in all reporting, analysis, and discussion of results. This recommended reporting is in addition to the requirements in 11.1.1.

1.4 Requirements are set on specimen size and the number of replicate tests that are needed to establish acceptable characterization of K_{Jc} data populations.

1.5 T_o is dependent on loading rate. T_o is evaluated for a quasi-static loading rate range with $0.1 < dK/dt < 2$ MPa $\sqrt{m/s}$. Slowly loaded specimens ($dK/dt < 0.1$ MPa \sqrt{m}) can be analyzed if environmental effects are known to be negligible. Provision is also made for higher loading rates ($dK/dt > 2$ MPa $\sqrt{m/s}$).

1.6 The statistical effects of specimen size on K_{Jc} in the transition range are treated using weakest-link theory (4) applied to a three-parameter Weibull distribution of fracture toughness values. A limit on K_{Jc} values, relative to the specimen size, is specified to ensure high constraint conditions along the crack front at fracture. For some materials, particularly those with low strain hardening, this limit may not be sufficient to ensure that a single-parameter (K_{Jc}) adequately describes the crack-front deformation state (5).

1.7 Statistical methods are employed to predict the transition toughness curve and specified tolerance bounds for 1T specimens of the material tested. The standard deviation of the data distribution is a function of Weibull slope and median K_{Jc} . The procedure for applying this information to the establishment of transition temperature shift determinations and the establishment of tolerance limits is prescribed.

1.8 The fracture toughness evaluation of nonuniform material is not amenable to the statistical analysis methods employed in this standard. Materials must have macroscopically uniform tensile and toughness properties. For example, multipass weldments can create heat-affected and brittle zones with localized properties that are quite different from either the bulk material or weld. Thick section steel also often exhibits some variation in properties near the surfaces. Metallography and initial screening may be necessary to verify the applicability of these and similarly graded materials. Particular notice should be given to the 2% and 98% tolerance bounds on K_{Jc} presented

¹ This test method is under the jurisdiction of ASTM Committee E08 on Fatigue and Fracture and is the direct responsibility of E08.07 on Fracture Mechanics.

Current edition approved June 1, 2009. Published August 2009. Originally approved in 1997. Last previous edition approved in 2009 as E 1921 – 09a.

² The boldface numbers in parentheses refer to the list of references at the end of this standard.

in 9.3. Data falling outside these bounds may indicate nonuniform material properties.

1.9 *This standard does not purport to address all of the safety concerns, if any, associated with its use. It is the responsibility of the user of this standard to establish appropriate safety and health practices and determine the applicability of regulatory limitations prior to use.*

2. Referenced Documents

2.1 ASTM Standards:³

- [E 4 Practices for Force Verification of Testing Machines](#)
- [E 8/E 8M Test Methods for Tension Testing of Metallic Materials](#)
- [E 23 Test Methods for Notched Bar Impact Testing of Metallic Materials](#)
- [E 74 Practice of Calibration of Force-Measuring Instruments for Verifying the Force Indication of Testing Machines](#)
- [E 208 Test Method for Conducting Drop-Weight Test to Determine Nil-Ductility Transition Temperature of Ferritic Steels](#)
- [E 399 Test Method for Linear-Elastic Plane-Strain Fracture Toughness \$K_{Ic}\$ of Metallic Materials](#)
- [E 436 Test Method for Drop-Weight Tear Tests of Ferritic Steels](#)
- [E 561 Test Method for \$K-R\$ Curve Determination](#)
- [E 1820 Test Method for Measurement of Fracture Toughness](#)
- [E 1823 Terminology Relating to Fatigue and Fracture Testing](#)

3. Terminology

3.1 Terminology given in Terminology E 1823 is applicable to this test method.

3.2 Definitions:

3.2.1 *ferritic steels*—are typically carbon, low-alloy, and higher alloy grades. Typical microstructures are bainite, tempered bainite, tempered martensite, and ferrite and pearlite. All ferritic steels have body centered cubic crystal structures that display ductile-to-cleavage transition temperature fracture toughness characteristics. See also Test Methods E 23, E 208 and E 436.

NOTE 1—This definition is not intended to imply that all of the many possible types of ferritic steels have been verified as being amenable to analysis by this test method.

3.2.2 *stress-intensity factor*, $K[FL^{-3/2}]$ —the magnitude of the mathematically ideal crack-tip stress field coefficient (stress field singularity) for a particular mode of crack-tip region deformation in a homogeneous body.

3.2.3 *Discussion*—In this test method, Mode I is assumed. See Terminology E 1823 for further discussion.

3.2.4 *J-integral*, $J[FL^{-1}]$ —a mathematical expression; a line or surface integral that encloses the crack front from one

crack surface to the other; used to characterize the local stress-strain field around the crack front (6). See Terminology E 1823 for further discussion.

3.3 Definitions of Terms Specific to This Standard:

3.3.1 *control force*, $P_m[F]$ —a calculated value of maximum force used in Test Method E 1820, Eqs. A1.1 and A2.1 to stipulate allowable precracking limits.

3.3.1.1 *Discussion*—In this method, P_m is not used for precracking, but is used as a minimum force value above which partial unloading is started for crack growth measurement.

3.3.2 *crack initiation*—describes the onset of crack propagation from a preexisting macroscopic crack created in the specimen by a stipulated procedure.

3.3.3 *effective modulus*, $E_e[FL^{-2}]$ —an elastic modulus that can be used with experimentally determined elastic compliance to effect an exact match to theoretical (modulus-normalized) compliance for the actual initial crack size, a_o .

3.3.4 *effective yield strength*, $\sigma_Y[FL^{-2}]$ —an assumed value of uniaxial yield strength that represents the influence of plastic yielding upon fracture test parameters.

3.3.4.1 *Discussion*—It is calculated as the average of the 0.2 % offset yield strength σ_{YS} , and the ultimate tensile strength, σ_{TS} as follows:

$$\sigma_Y = \frac{(\sigma_{YS} + \sigma_{TS})}{2}$$

3.3.5 *elastic modulus*, $E'[FL^{-2}]$ —a linear-elastic factor relating stress to strain, the value of which is dependent on the degree of constraint. For plane stress, $E' = E$ is used, and for plane strain, $E/(1 - \nu^2)$ is used, with E being Young's modulus and ν being Poisson's ratio.

3.3.6 *elastic plastic $J_c[FL^{-1}]$* — J -integral at the onset of cleavage fracture.

3.3.7 *elastic-plastic $K_J[FL^{-3/2}]$* —An elastic-plastic equivalent stress intensity factor derived from the J -integral.

3.3.7.1 *Discussion*—In this test method, K_J also implies a stress intensity factor determined at the test termination point under conditions determined to be invalid by 8.9.2.

3.3.8 *elastic-plastic $K_{Jc}[FL^{-3/2}]$* —an elastic-plastic equivalent stress intensity factor derived from the J -integral at the point of onset of cleavage fracture, J_c .

3.3.9 *equivalent value of median toughness*, $K_{Jc}^{eq}[FL^{-3/2}]$ —an equivalent value of the median toughness for a multi-temperature data set.

3.3.10 *Eta (η)*—a dimensionless parameter that relates plastic work done on a specimen to crack growth resistance defined in terms of deformation theory J -integral (7).

3.3.11 *failure probability*, p_f —the probability that a single selected specimen chosen at random from a population of specimens will fail at or before reaching the K_{Jc} value of interest.

3.3.12 *initial ligament length*, $b_o[L]$ —the distance from the initial crack tip, a_o , to the back face of a specimen.

3.3.13 *load-line displacement rate*, $\dot{\Delta}_{LL}[LT^{-1}]$ —rate of increase of specimen load-line displacement.

3.3.14 *pop-in*—a discontinuity in a force versus displacement test record (8).

³ For referenced ASTM standards, visit the ASTM website, www.astm.org, or contact ASTM Customer Service at service@astm.org. For *Annual Book of ASTM Standards* volume information, refer to the standard's Document Summary page on the ASTM website.

3.3.14.1 *Discussion*—A pop-in event is usually audible, and is a sudden cleavage crack initiation event followed by crack arrest. A test record will show increased displacement and drop in applied force if the test frame is stiff. Subsequently, the test record may continue on to higher forces and increased displacement.

3.3.15 *precracked Charpy specimen*—SE(B) specimen with $W = B = 10$ mm (0.394 in.).

3.3.16 *provisional reference temperature, (T_{oQ}) [°C]*—Interim T_o value calculated using the standard test method described herein. If all validity criteria are met then $T_o = T_{oQ}$.

3.3.17 *reference temperature, T_o [°C]*—The test temperature at which the median of the K_{Jc} distribution from 1T size specimens will equal $100 \text{ MPa}\sqrt{\text{m}}$ ($91.0 \text{ ksi}\sqrt{\text{in.}}$).

3.3.18 *SE(B) specimen span, $S[L]$* —the distance between specimen supports (See Test Method E 1820 Fig. 3).

3.3.19 *specimen thickness, $B[L]$* —the distance between the parallel sides of a test specimen as depicted in Figs. 1-3.

3.3.19.1 *Discussion*—In the case of side-grooved specimens, the net thickness, B_N , is the distance between the roots of the side-groove notches.

3.3.20 *specimen size, nT* —a code used to define specimen dimensions, where n is expressed in multiples of 1 in.

3.3.20.1 *Discussion*—In this method, specimen proportionality is required. For compact specimens and bend bars, specimen thickness $B = n$ inches.

3.3.21 *temperature, T_{oX}^{est} [°C]*—estimated value of the reference temperature corresponding to an elevated loading rate X , to be used only for test temperature selection in accordance with 8.4.2.

3.3.22 *temperature, T_Q [°C]*—For K_{Jc} values that are developed using specimens or test practices, or both, that do not conform to the requirements of this test method, a temperature at which $K_{Jc(med)} = 100 \text{ MPa}\sqrt{\text{m}}$ is defined as T_Q . T_Q is not a provisional value of T_o .

3.3.23 *test loading rate \dot{K} [FL^{-3/2}T⁻¹]*—rate of increase of applied stress intensity factor.

3.3.23.1 *Discussion*—It is generally evaluated as the ratio between K_{Jc} and the corresponding time to cleavage. For tests where partial unloading compliance an equivalent time to cleavage t_c shall be used to calculate the loading rate. The value of t_c is calculated as the ratio between the value of load-line displacement at cleavage and the load-line displacement rate applied during the monotonic loading portions of the test (that is, the periods between partial unloading/reloading sequences used for compliance measurement).

3.3.24 *time to control force, t_m [T]*,—time to P_m .

3.3.25 *Weibull fitting parameter, K_0* —a scale parameter located at the 63.2 % cumulative failure probability level (9). $K_{Jc} = K_0$ when $p_f = 0.632$.

3.3.26 *Weibull slope, b* —with p_f and K_{Jc} data pairs plotted in linearized Weibull coordinates obtainable by rearranging Eq. 15, b is the slope of a line that defines the characteristics of the typical scatter of K_{Jc} data.

3.3.26.1 *Discussion*—A Weibull slope of 4 is used exclusively in this method.

3.3.27 *yield strength, σ_{YS} [FL⁻²]*—the stress at which a material exhibits a specific limiting deviation from the proportionality of stress to strain at the test temperature. This deviation is expressed in terms of strain.

3.3.27.1 *Discussion*—1 It is customary to determine yield strength by either (1) Offset Method (usually a strain of 0.2 % is specified) or (2) Total-Extension-Under-Force Method (usually a strain of 0.5 % is specified although other values of strain may be used).

3.3.27.2 *Discussion*—2 Whenever yield strength is specified, the method of test must be stated along with the percent offset or total strain under force. The values obtained by the two methods may differ.

4. Summary of Test Method

4.1 This test method involves the testing of notched and fatigue precracked bend or compact specimens in a temperature range where either cleavage cracking or crack pop-in develop during the loading of specimens. Crack aspect ratio, a/W , is nominally 0.5. Specimen width in compact specimens is two times the thickness. In bend bars, specimen width can be either one or two times the thickness.

4.2 Force versus displacement across the notch at a specified location is recorded by autographic recorder or computer data acquisition, or both. Fracture toughness is calculated at a defined condition of crack instability. The J -integral value at instability, J_c , is calculated and converted into its equivalent in units of stress intensity factor, K_{Jc} . Validity limits are set on the suitability of data for statistical analyses.

4.3 Tests that are replicated at least six times can be used to estimate the median K_{Jc} of the Weibull distribution for the data population (10). Extensive data scatter among replicate tests is expected. Statistical methods are used to characterize these data populations and to predict changes in data distributions with changed specimen size.

4.4 The statistical relationship between specimen size and K_{Jc} fracture toughness can be assessed using weakest-link theory, thereby providing a relationship between the specimen size and K_{Jc} (4). Limits are placed on the fracture toughness range over which this model can be used.

4.5 For definition of the toughness transition curve, a master curve concept is used (11, 12). The position of the curve on the temperature coordinate is established from the experimental determination of the temperature, designated T_o , at which the median K_{Jc} for 1T size specimens is $100 \text{ MPa}\sqrt{\text{m}}$ ($91.0 \text{ ksi}\sqrt{\text{in.}}$). Selection of a test temperature close to that at which the median K_{Jc} value will be $100 \text{ MPa}\sqrt{\text{m}}$ is encouraged and a means of estimating this temperature is suggested. Small specimens such as precracked Charpy's may have to be tested at temperatures below T_o where $K_{Jc(med)}$ is well below $100 \text{ MPa}\sqrt{\text{m}}$. In such cases, additional specimens may be required as stipulated in 8.5.

4.6 Tolerance bounds can be determined that define the range of scatter in fracture toughness throughout the transition range. The standard deviation of the fitted distribution is a function of Weibull slope and median K_{Jc} value, $K_{Jc(med)}$.

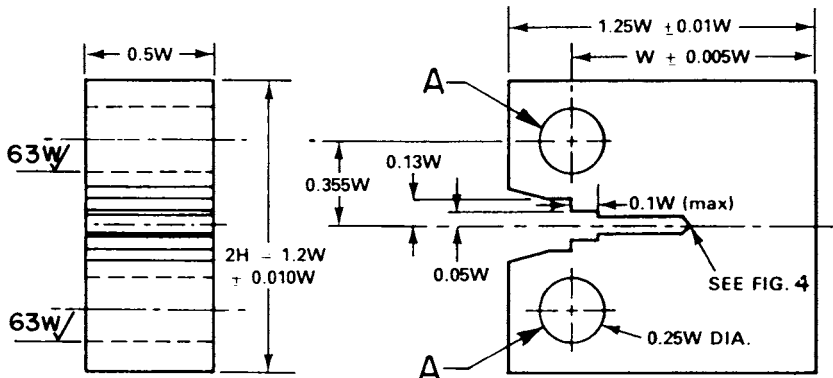
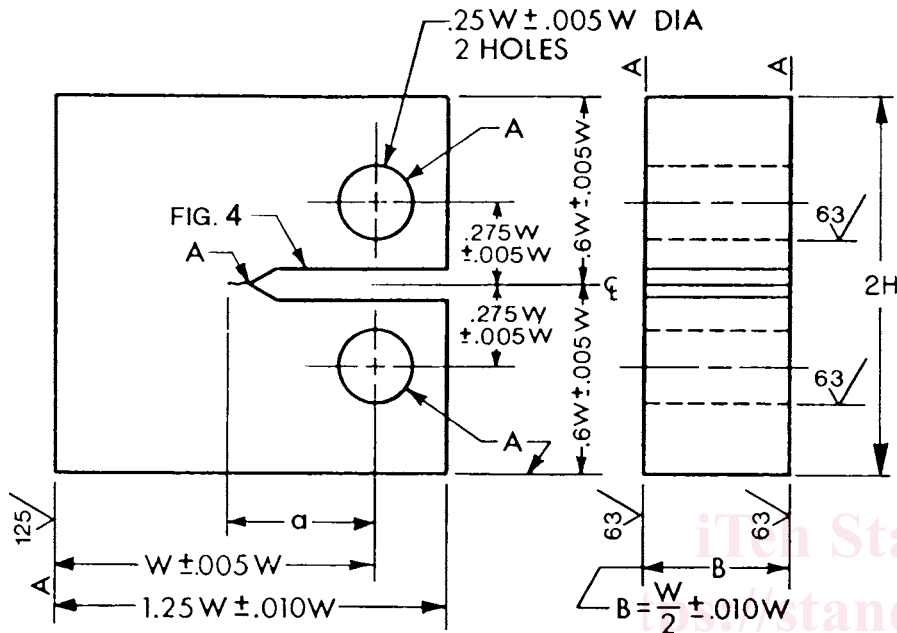

COMPACT TEST SPECIMEN FOR PIN OF 0.24W (+0.000W/ -0.005W) DIAMETER

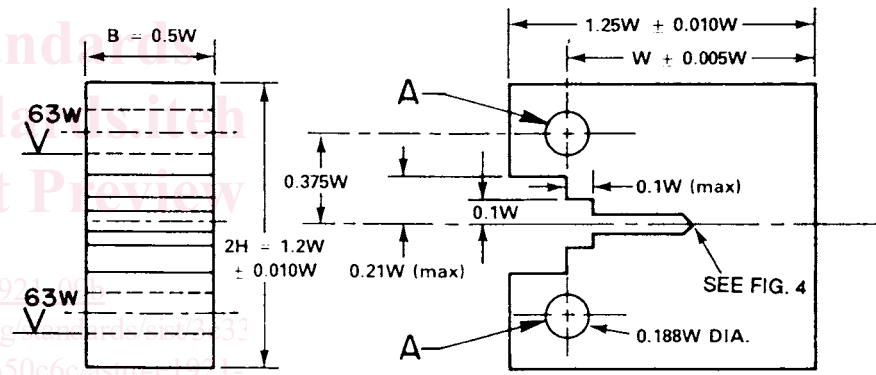

COMPACT TEST SPECIMEN FOR PIN OF 0.1875W (+0.000W/ -0.001W) DIAMETER

NOTE 1—"A" surfaces shall be perpendicular and parallel as applicable to within 0.002W TIR.

NOTE 2—The intersection of the crack starter notch tips with the two specimen surfaces shall be equally distant from the top and bottom edges of the specimen within 0.005W TIR.

FIG. 1 Recommended Compact Specimen Designs

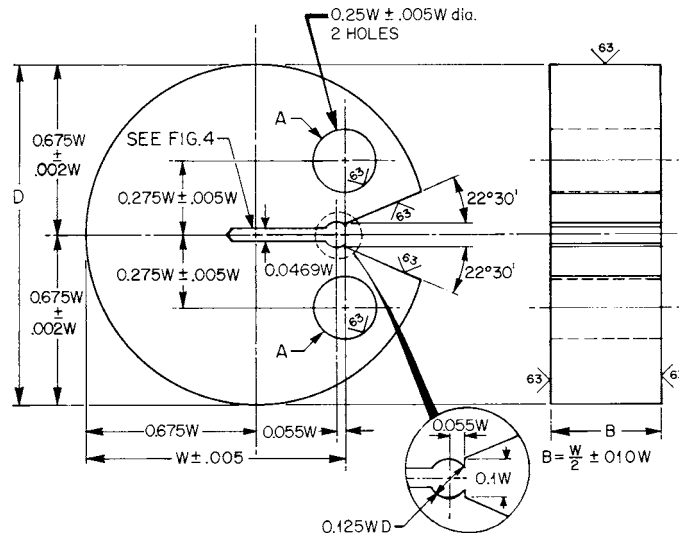

NOTE 1—A surfaces shall be perpendicular and parallel as applicable to within 0.002W TIR.

NOTE 2—The intersection of the crack starter notch tips with the two specimen surfaces shall be equally distant from the top and bottom extremes of the disk within 0.005W TIR.

NOTE 3—Integral or attached knife edges for clip gage attachment may be used. See also Fig. 6, Test Method E 399.

FIG. 2 Disk-shaped Compact Specimen DC(T) Standard Proportions

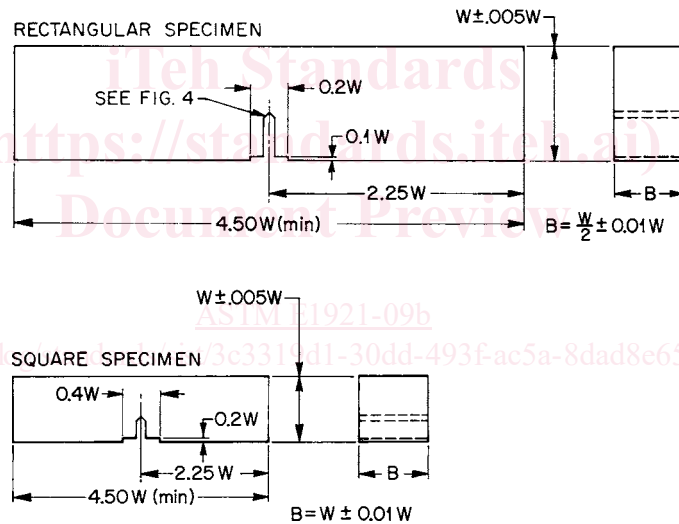

NOTE 1—All surfaces shall be perpendicular and parallel within 0.001W TIR; surface finish 64v.

NOTE 2—Crack starter notch shall be perpendicular to specimen surfaces to within ± 2°.

FIG. 3 Recommended Bend Bar Specimen Design

5. Significance and Use

5.1 Fracture toughness is expressed in terms of an elastic-plastic stress intensity factor, K_{Jc} , that is derived from the J -integral calculated at fracture.

5.2 Ferritic steels are inhomogeneous with respect to the orientation of individual grains. Also, grain boundaries have properties distinct from those of the grains. Both contain carbides or nonmetallic inclusions that can act as nucleation sites for cleavage microcracks. The random location of such nucleation sites with respect to the position of the crack front manifests itself as variability of the associated fracture tough-

ness (13). This results in a distribution of fracture toughness values that is amenable to characterization using statistical methods.

5.3 Distributions of K_{Jc} data from replicate tests can be used to predict distributions of K_{Jc} for different specimen sizes. Theoretical reasoning (9), confirmed by experimental data, suggests that a fixed Weibull slope of 4 applies to all data distributions and, as a consequence, standard deviation on data scatter can be calculated. Data distribution and specimen size effects are characterized using a Weibull function that is coupled with weakest-link statistics (14). An upper limit on

constraint loss and a lower limit on test temperature are defined between which weakest-link statistics can be used.

5.4 The experimental results can be used to define a master curve that describes the shape and location of median K_{Jc} transition temperature fracture toughness for 1T specimens (15). The curve is positioned on the abscissa (temperature coordinate) by an experimentally determined reference temperature, T_o . Shifts in reference temperature are a measure of transition temperature change caused, for example, by metallurgical damage mechanisms.

5.5 Tolerance bounds on K_{Jc} can be calculated based on theory and generic data. For added conservatism, an offset can be added to tolerance bounds to cover the uncertainty associated with estimating the reference temperature, T_o , from a relatively small data set. From this it is possible to apply a margin adjustment to T_o in the form of a reference temperature shift.

5.6 For some materials, particularly those with low strain hardening, the value of T_o may be influenced by specimen size due to a partial loss of crack-tip constraint (5). When this occurs, the value of T_o may be lower than the value that would be obtained from a data set of K_{Jc} values derived using larger specimens.

6. Apparatus

6.1 *Precision of Instrumentation*—Measurements of applied forces and load-line displacements are needed to obtain work done on the specimen. Force versus load-line displacements may be recorded digitally on computers or autographically on x - y plotters. For computers, digital signal resolution should be 1/32,000 of the displacement transducer signal range and 1/4,000 of the force transducer signal range.

6.2 *Grips for C(T) Specimens*—A clevis with flat-bottom holes is recommended. See Test Method E 399-90, Fig. A6.2, for a recommended design. Clevises and pins should be fabricated from steels of sufficient strength to elastically resist indentation loads (greater than 40 Rockwell hardness C scale (HRC)).

6.3 *Bend Test Fixture*—A suitable bend test fixture scheme is shown in Fig. A3.2 of Test Method E 399-90. It allows for roller pin rotation and minimizes friction effects during the test. Fixturing and rolls should be made of high-hardness steel (HRC greater than 40).

6.4 *Displacement Gage for Compact Specimens:*

6.4.1 Displacement measurements are made so that J values can be determined from area under force versus displacement test records (a measure of work done). If the test temperature selection recommendations of this practice are followed, crack growth measurement will probably prove to be unimportant. Results that fall within the limits of uncertainty of the recommended test temperature estimation scheme will probably not have significant slow-stable crack growth prior to instability. Nevertheless, crack growth measurements are recommended to provide supplementary information, and these results may be reported.

6.4.2 Unloading compliance is the primary recommendation for measuring slow-stable crack growth. See Test Method E 1820. When multiple tests are performed sequentially at low test temperatures, there will be condensation and ice buildup

on the grips between the loading pins and flats of the clevis holes. Ice will interfere with the accuracy of the unloading compliance method. Alternatively, crack growth can be measured by other methods such as electric potential, but care must be taken to avoid specimen heating when low test temperatures are used.

6.4.3 In compact C(T) specimens, displacement measurements on the load-line are recommended for J determinations. However, the front face position at 0.25W in front of the load-line can be used with interpolation to load-line displacement, as suggested in 7.1.

6.4.4 The extensometer calibrator shall be resettable at each displacement interval within 0.0051 mm (0.0002 in.). Accuracy of the clip gage at test temperature must be demonstrated to be within 1 % of the working range of the gage.

6.4.5 All clip gages used shall have temperature compensation.

6.5 *Displacement Gages for Bend Bars, SE(B):*

6.5.1 The SE(B) specimen has two displacement gage locations. A load-line displacement transducer is primarily intended for J computation, but may also be used for calculations of crack size based on elastic compliance, if provision is made to subtract the extra displacement due to the elastic compliance of the fixturing. The load-line gage shall display accuracy of 1 % over the working range of the gage. The gages used shall not be temperature sensitive.

6.5.2 Alternatively, a crack-mouth opening displacement (CMOD) gage can also be used to determine the plastic part of J . However, it is necessary to employ a plastic eta (η_p) value developed specifically for that position (16) or to infer load-point displacement from mouth opening using an expression that relates the two displacements (17). In either case, the procedure described in 9.1.4 is used to calculate the plastic part of J . The CMOD position is the most accurate for the compliance method of slow-stable crack growth measurement.

6.5.3 Crack growth can be measured by alternative methods such as electric potential, but care must be taken to minimize specimen heating effects in low-temperature tests (see also 6.4.2) (18).

6.6 *Force Measurement:*

6.6.1 Testing shall be performed in a machine conforming to Practices of E 4-93 and E 8M-95. Applied force may be measured by any transducer with a noise-to-signal ratio less than 1/2,000 of the transducer signal range.

6.6.2 Calibrate force measurement instruments by way of Practice E 74-91, 10.2. Annual calibration using calibration equipment traceable to the National Institute of Standards and Technology is a mandatory requirement.

6.7 *Temperature Control*—Specimen temperature shall be measured with thermocouple wires and potentiometers. It is recommended that the two thermocouple wires be attached to the specimen surface separately, either by welding, spot welding, or by being affixed mechanically. Mechanical attachment schemes must be verified to provide equivalent temperature measurement accuracy. The purpose is to use the test material as a part of the thermocouple circuit (see also 8.6.1). Accuracy of temperature measurement shall be within 3°C of true temperature and repeatability among specimens shall be within

2°C. Precision of measurement shall be ±1°C or better. The temperature measuring apparatus shall be checked every six months using instruments traceable to the National Institute of Standards and Technology in order to ensure the required accuracy.

7. Specimen Configuration, Dimensions, and Preparation

7.1 Compact Specimens—Three recommended C(T) specimen designs are shown in Fig. 1. One C(T) specimen configuration is taken from Test Method E 399-90; the two with cutout sections are taken from E 1820. The latter two designs are modified to permit load-line displacement measurement. Room is provided for attachment of razor blade tips on the load-line. Care should be taken to maintain parallel alignment of the blade edges. When front face (at 0.25W in front of the load-line) displacement measurements are made with the Test Method E 399 design, the load-line displacement can be inferred by multiplying the measured values by the constant 0.73 (19). The ratio of specimen height to width, 2H/W is 1.2, and this ratio is to be the same for all types and sizes of C(T) specimens. The initial crack size, a_o , shall be $0.5W \pm 0.05W$. Specimen width, W, shall be 2B.

7.2 Disk-shaped Compact Specimens—A recommended DC(T) specimen design is shown in Fig. 2. Initial crack size, a_o , shall be $0.5W \pm 0.05W$. Specimen width shall be 2B.

7.3 Single-edge Notched Bend—The recommended SE(B) specimen designs, shown in Fig. 3, are made for use with a span-to-width ratio, S/W = 4. The width, W, can be either 1B or 2B. The initial crack size, a_o , shall be $0.5W \pm 0.05W$.

7.4 Machined Notch Design—The machined notch plus fatigue crack for all specimens shall lie within the envelope shown in Fig. 4.

7.5 Specimen Dimension Requirements—The crack front straightness criterion defined in 8.9.1 must be satisfied. The specimen remaining ligament, b_o , must have sufficient size to maintain a condition of high crack-front constraint at fracture. The maximum K_{Jc} capacity of a specimen is given by:

$$K_{Jc(\text{limit})} = \sqrt{\frac{Eb_o\sigma_{YS}}{30(1 - \nu^2)}} \tag{1}$$

where:

$$b_o = W - a_o$$

K_{Jc} data that exceed this requirement may be used in a data censoring procedure. Details of this procedure are described in section 10.2.2 for single-temperature data and 10.4.2 for multi-temperature data.

7.6 Small Specimens—At high values of fracture toughness relative to specimen size and material flow properties, the values of K_{Jc} that meet the requirements of Eq 1 may not

Notch and required crack envelope

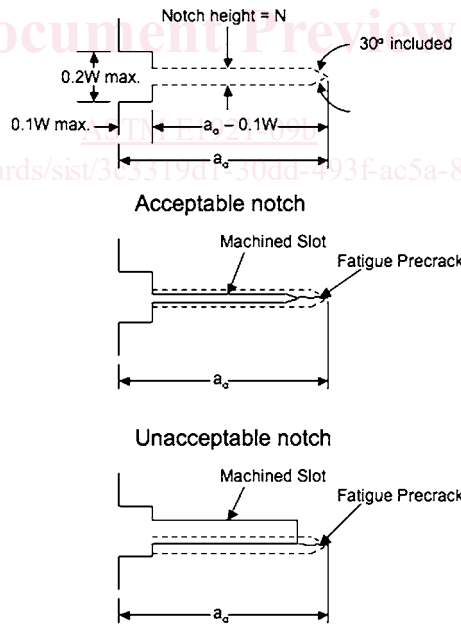

Notch and Precrack Configurations

	Wide Notch	Narrow Notch
Maximum Notch Height	Lesser of 0.063W or 6.25 mm	0.01W
Maximum Notch Angle	60°	As machined
Minimum Precrack Length	Greater of 0.5N or 1.3 mm	Greater of 0.5N or 0.6mm

NOTE 1—The crack-starter notch shall be centered between the top and bottom specimen edges within 0.005W.

FIG. 4 Envelope of Fatigue Crack and Crack Starter Notches

always provide a unique description of the crack-front stress-strain fields due to some loss of constraint caused by excessive plastic flow (5). This condition may develop in materials with low strain hardening. When this occurs, the highest K_{Jc} values of the valid data set could possibly cause the value of T_o to be lower than the value that would be obtained from testing specimens with higher constraint.

7.7 *Side Grooves*—Side grooves are optional. Precracking prior to side-grooving is recommended, despite the fact that crack growth on the surfaces might be slightly behind. Specimens may be side-grooved after precracking to decrease the curvature of the initial crack front. In fact, side-grooving may be indispensable as a means for controlling crack front straightness in bend bars of square cross section. The total side-grooved depth shall not exceed 0.25B. Side grooves with an included angle of 45° and a root radius of 0.5 ± 0.2 mm (0.02 ± 0.01 in.) usually produce the desired results.

7.8 *Precracking*:

7.8.1 *Fatigue Loading Requirements*—Allowable fatigue force values are limited to keep the maximum stress intensity factor applied during precracking, K_{max} , well below the material fracture toughness measured during the subsequent test.

The fatigue precracking shall be conducted with the specimen fully heat-treated to the condition in which it is to be tested. No intermediate heat treatments between precracking and testing are allowed. The combination of starter notch and fatigue precrack shall conform to the requirements shown in Fig. 4. There are several ways of promoting early crack initiation: (1) by providing a very sharp notch tip, (2) by using a chevron notch (Fig. 5), (3) by statically preloading the specimen in such a way that the notch tip is compressed in a direction normal to the intended crack plane (to a force not to exceed P_m), and (4) by using a negative fatigue force ratio; for a given maximum fatigue force, the more negative the force ratio, the earlier crack initiation is likely to occur. The peak compressive force shall not exceed P_m as defined in E 1820-05 Annex A1-Annex A3.

7.8.2 *Fatigue Precracking Procedure*—Fatigue precracking can be conducted under either force control, displacement control or K control. If the force cycle is maintained constant, the maximum K and ΔK will increase with crack size; if the displacement cycle is maintained constant, the reverse will happen. If K is maintained constant, force has to be reduced as a function of increasing crack size. The initial value of the

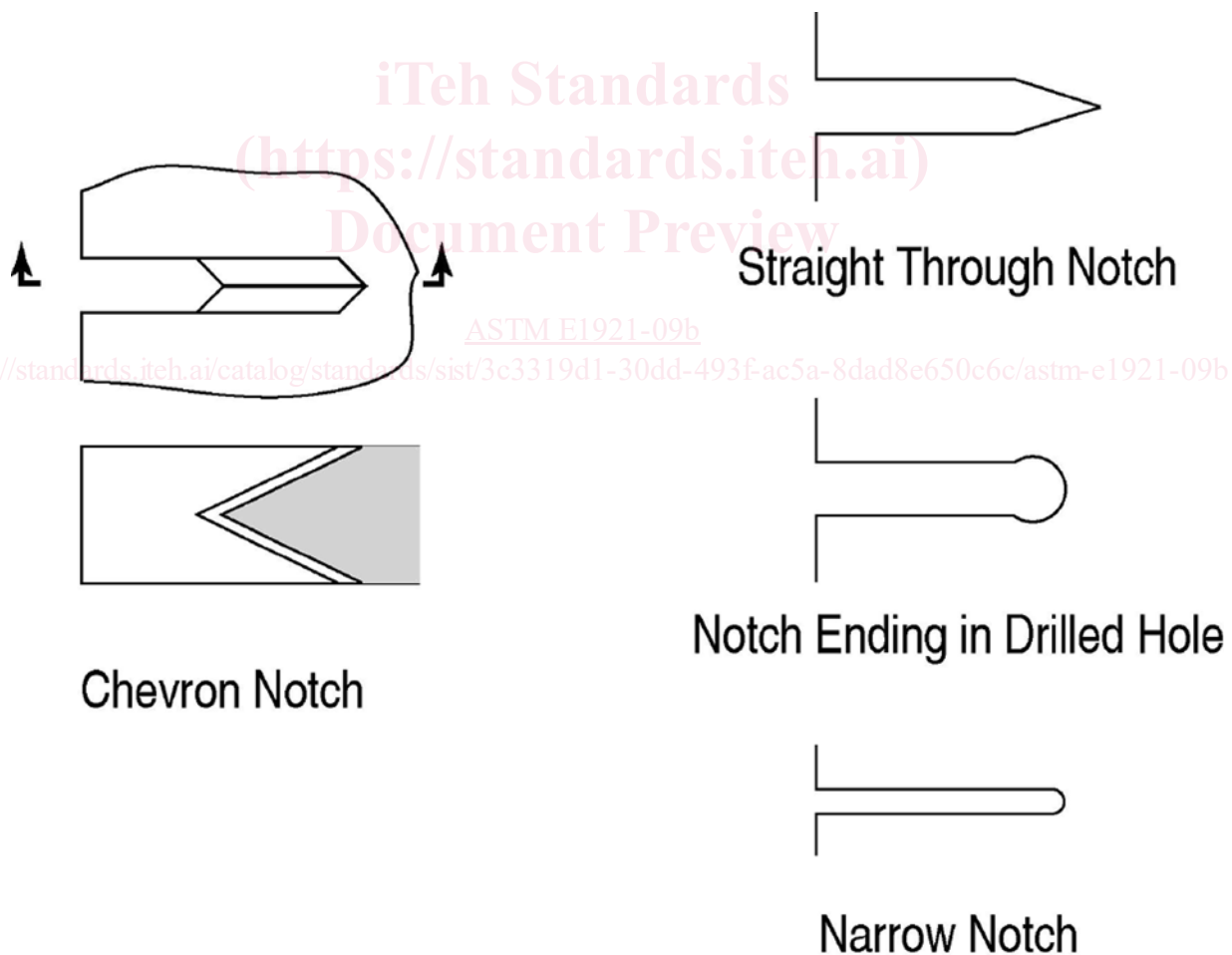

NOTE 1—Notch width need not be less than 1.6mm (1/16 in.) but not exceed 0.063W.

NOTE 2—The intersection of the crack starter surfaces with the two specimen faces shall be equidistant from the top and bottom edges of the specimen within 0.005W.

FIG. 5 Envelope Crack Starter Notches

maximum fatigue force should be less than P_m . The specimen shall be accurately located in the loading fixture. Fatigue cycling is then begun, usually with a sinusoidal waveform and a frequency close to the highest practical value. There is no known marked frequency effect on fatigue precrack formation up to at least 100 Hz in the absence of adverse environments. The specimen should be carefully monitored until crack initiation is observed on one side. If crack initiation is not observed on the other side before appreciable growth is observed on the first side, then fatigue cycling should be stopped to try to determine the cause and find a remedy for the unsymmetrical behavior. Sometimes, simply turning the specimen around in relation to the fixture will solve the problem. The length of the fatigue precrack extension from the machined notch shall not be less than the greater of 1.3 mm (0.05 in.) or 0.5N (see Fig. 4) for the wide notch, nor less than the greater of 0.6 mm (0.024 in.) or 0.5N (see Fig. 4) for the narrow notch. Precracking can be performed either by using at least two discrete steps or by some method of smoothly and continually decreasing K_{max} . For the discrete step method, it is suggested that the reduction in P_{max} for any of these steps be no greater than 20% and that measurable crack extension occur before proceeding to the next step. For the initial step the maximum stress intensity factor applied to the specimen shall be limited by:

$$K_{max} = 25MPa\sqrt{m}$$

or

$$K_{max} = 22.8 \text{ ksi}\sqrt{\text{in.}}$$

It is generally most effective to use $R = P_{min}/P_{max} = 0.1$. The accuracy of the maximum force values shall be known within $\pm 5\%$. The minimum length for the final precracking step shall be the lesser of 50% of the fatigue precrack growth or 1.3 mm (0.05 in.) for the wide notch or 0.6 mm (0.024 in.) for the narrow notch. Testing at temperatures significantly lower than the precracking temperature increases the warm prestressing effect which can elevate the measured toughness properties. To minimize this effect, when the testing temperature is less than the precracking temperature, the maximum stress intensity factor that may be applied to the specimen during the final precracking step shall be given by:

$$K_{max} = 15MPa\sqrt{m}$$

or

$$K_{max} = 13.7 \text{ ksi}\sqrt{\text{in.}}$$

Alternatively, when the testing temperature is equal to or above the precracking temperature, the maximum stress intensity factor that may be applied to the specimen during the final precracking step shall be given by:

$$K_{max} = 20MPa\sqrt{m}$$

or

$$K_{max} = 18.3 \text{ ksi}\sqrt{\text{in.}}$$

When K_{max} is smoothly and continually reduced during precracking, only the final 0.2 mm (0.008 in.) of fatigue precracking is required to be conducted at or below the appropriate K_{max} values for this final precracking step.

8. Procedure

8.1 Testing Procedure—The objective of the procedure described here is to determine the J -integral at the point of crack instability, J_c . Crack growth can be measured by partial unloading compliance, or by any other method that has precision and accuracy, as defined below. However, the J -integral is not corrected for slow-stable crack growth in this test method.

8.2 Test Preparation—Prior to each test, certain specimen dimensions should be measured, the clip gage checked, and the starting crack size estimated from the average of the optical side face measurements.⁴

8.2.1 The dimensions B , B_N , and W shall be measured to within 0.05 mm (0.002 in.) accuracy or 0.5 %, whichever is larger.

8.2.2 Because most tests conducted under this method will terminate in specimen instability, clip gages tend to be abused, thus they shall be examined for damage after each test and checked electronically before each test. Clip gages shall be calibrated at the beginning of each day of use, using an extensometer calibrator as specified in 6.4.4.

8.2.3 Follow Test Method E 1820, 8.5 for crack size measurement, 8.3.2 for testing compact specimens and 8.3.1 for testing bend specimens.

8.3 The required minimum number of valid K_{Jc} tests is specified according to the value of $K_{Jc(med)}$. See also 8.5.

8.4 Test Temperature Selection—It is recommended that the selected temperature be close to that at which the $K_{Jc(med)}$ value will be about 100 MPa \sqrt{m} for the specimen size selected.

8.4.1 Quasi-static loading rates—If loading rate complies with the limits stated in 8.7.1, Charpy V-notch data can be used as an aid for predicting a viable test temperature. If a Charpy transition temperature, T_{CVN} , is known corresponding to a 28J Charpy V-notch energy or a 41J Charpy V-notch energy, a constant C can be chosen from Table 1 corresponding to the test specimen size (defined in 3.3.20), and used to estimate⁵ the test temperature from (12, 20).

$$T = T_{CVN} + C \quad (2)$$

TABLE 1 Constants for Test Temperature Selection Based on Charpy Results

Specimen Size, (nT)	Constant C (°C)	
	28J	41J
0.4 ^A	-32	-38
0.5	-28	-34
1	-18	-24
2	-8	-14
3	-1	-7
4	2	-4

^A For precracked Charpy specimens, use $C = -50$ or -56°C .

8.4.2 Elevated loading rates—If tests at elevated loading rates (8.7.2) are performed and if the value of T_0 under the quasi-static loading rate conditions is known, the following

⁴ When side-grooving is to be used, first precrack without side grooves and optically measure the fatigue crack growth on both surfaces.

⁵ Standard deviation on this estimate has been determined to be 15°C.

relationship can be used to derive an estimated value of $T_{o,X}$ ($T_{o,X}^{est}$) to facilitate test temperature selection (21).

$$T_{o,X}^{est} = \frac{(T_o + 273.15) \cdot \Gamma}{\Gamma - \ln(X)} - 273.15 \quad (3)$$

Where: $X = \dot{K}$ in $\text{MPa}\sqrt{\text{m/s}}$ and temperature is in $^{\circ}\text{C}$. The function of Γ is given by:

$$\Gamma = 9.9 \cdot \exp \left[\left[\frac{(T_o + 273.15)}{190} \right]^{1.66} + \left(\frac{\sigma_{ys}^{T_o}}{722} \right)^{1.09} \right] \quad (4)$$

$\sigma_{ys}^{T_o}$ = yield strength measured or estimated at T_o and at quasi-static rates ($\sim 10^{-6}$ to 10^{-4} s^{-1}).

See Practice E 8/E 8M for additional guidance. Eq 3 and Eq 4 shall not be used for calculating and reporting values of reference temperatures corresponding to elevated loading rates.

8.4.3 The procedures outlined 8.4.1 and 8.4.2 are only appropriate for determining an initial test temperature. The iterative scheme described in 10.4.3 may be necessary to refine this test temperature in order to increase T_o accuracy. Testing below the temperature specified in Eq 2 or Eq 3 may be appropriate for low upper-shelf toughness materials to avoid ductile crack growth before cleavage onset, and for low yield strength materials to avoid specimen size invalidity (Eq 1).⁶

8.5 *Testing Below Temperature, T_o* —When the equivalent value of $K_{Jc(med)}$ for 1T specimens is greater than $83 \text{ MPa}\sqrt{\text{m}}$, the required number of valid K_{Jc} values to perform the analyses covered in Section 10 is six. However, small specimens such as precracked Charpy specimens can develop excessive numbers of invalid K_{Jc} values by Eq 1 when testing close to the T_o temperature. In such cases it is advisable to test at temperatures below T_o , where most, if not all, K_{Jc} data developed can be valid. The disadvantage here is that the uncertainty in T_o determination increases as the lower-shelf toughness is approached. This increase in uncertainty can be countered by testing more specimens thereby increasing the $K_{Jc(med)}$ accuracy. Table 2 establishes the number of valid K_{Jc} test results required to evaluate T_o according to this test method. If $K_{Jc(med)}$ of a data set is lower than $58 \text{ MPa}\sqrt{\text{m}}$, then the T_o determination using that data set shall not be allowed.

TABLE 2 Number of Valid K_{Jc} Test Results Required to Evaluate T_o

$(T - T_o)$, range ($^{\circ}\text{C}$)	$K_{Jc(med)}$ range ^A ($\text{MPa}\sqrt{\text{m}}$)	Number of valid K_{Jc} required	Possible number of invalid tests by Eq 1 ^B
50 to -14	212 to 84	6	3
-15 to -35	83 to 66	7	1
-36 to -50	65 to 58	8	0

^A Convert $K_{Jc(med)}$ equivalence using Eq. 16. Round off to nearest whole digit.

^B Established specifically for precracked Charpy specimens. Use this column for total specimen needs.

8.6 *Specimen Test Temperature Control and Measurement*—For tests at temperatures other than ambient, any suitable means (liquid, gas vapor, or radiant heat) may be used to cool or heat the specimens, provided the region near the crack tip can be maintained at the desired temperature as defined in 6.7 during the conduct of the test.

8.6.1 The most dependable method of monitoring test temperature is to weld or spot weld each thermocouple wire separately to the specimen, spaced across the crack plane. The specimen provides the electrical continuity between the two thermocouple wires, and spacing should be enough not to raise any question of possible interference with crack tip deformation processes. Alternative attachment methods can be mechanical types such as drilled hole, or by a firm mechanical holding device so long as the attachment method is verified for accuracy and these practices do not disturb the crack tip stress field of the specimen during loading.

8.6.2 To verify that the specimen is properly seated into the loading device and that the clip gage is properly seated, repeated preloading and unloading in the linear elastic range shall be applied. Load and unload the specimen between force values of $0.2 P_{max}$ and P_{max} (where P_{max} is the top precracking force of the finishing cycles) at least three times. Check the calculated crack size from each unloading slope against the average precrack size defined in 8.2. Refer also to Test Method E 1820, Eq. A2.12 for C(T) specimens and to Eq. A1.10 for SE(B) specimens. Be aware that ice buildup at the loading clevis hole between tests can affect accuracy. Therefore, the loading pins and devices should be dried before each test. For working-in fixtures, the elastic modulus to be used should be the nominally known value, E , for the material, and for side-grooved specimens, the effective thickness for compliance calculations is defined as:

$$B_e = B_N(2 - B_N/B) \quad (5)$$

8.6.3 For J calculations in Section 9, B_N is used as the thickness dimension. All calculated crack sizes should be within 10 % of the visual average and replicate determinations within 1 % of each other. If the repeatability of determination is outside this limit, the test setup is suspect and should be thoroughly rechecked. After working-in the test fixtures, the force shall be returned to the lowest practical value at which the fixture alignment can be maintained.

8.7 *Testing for K_{Jc}* —All tests shall be conducted under displacement control. Force versus load-point displacement measurements shall be recorded. Periodic partial unloading can be used to determine the extent of slow-stable crack growth if it occurs. Alternative methods of measuring crack extension, for example the potential drop method, can be used (18). If displacement measurements are made at a location other than at the load point, the ability to infer load point displacement within 2 % of the absolute values shall be demonstrated. In the case of the front face for compact specimens (7.1), this requirement has been sufficiently proven so that no demonstration is required. For bend bars, see 6.5.2. Crack size prediction from partial unloading slopes at a different location will require different compliance calibration equations than those recommended in 8.6.2. Table 2 in Practice E 561-92a contains equations that define compliance for other locations on the compact specimen.

8.7.1 *Quasi-static Loading*—Load specimens at a rate such that \dot{K} during the initial elastic portion is between 0.1 and 2 $\text{MPa}\sqrt{\text{m/s}}$. Variation of the loading rate within these limits allows obtaining a T_o which is insensitive to the loading rate

⁶ Data validation is covered in 8.9.2 and Section 10.