



## Standard Specification for Drain, Waste, and Vent (DWV) Plastic Fittings Patterns<sup>1</sup>

This standard is issued under the fixed designation D3311; the number immediately following the designation indicates the year of original adoption or, in the case of revision, the year of last revision. A number in parentheses indicates the year of last reapproval. A superscript epsilon ( $\epsilon$ ) indicates an editorial change since the last revision or reapproval.

### 1. Scope\*

1.1 This specification provides standard fitting geometries and laying lengths for plastic fittings intended for use in drain, waste, and vent applications. (See Specifications D2661 and D2665.)

1.2 Fittings meeting the requirements of this standard specification are designed for use with outside diameter controlled pipe. The inside diameter can vary significantly as the wall thickness and outside diameter varies and therefore is not suitable for use as a fitting socket.

1.3 The values stated in inch-pound units are to be regarded as standard. The values given in parentheses are mathematical conversions to SI units that are provided for information only and are not considered standard.

### 2. Referenced Documents

#### 2.1 ASTM Standards:<sup>2</sup>

<sup>1</sup> This specification is under the jurisdiction of ASTM Committee F17 on Plastic Piping Systems and is the direct responsibility of Subcommittee F17.63 on DWV. Current edition approved Aug. 1, 2009. Published August 2009. Originally approved in 1974. Last previous edition approved in 2009 as D3311–09. DOI: 10.1520/D3311-09A.

<sup>2</sup> For referenced ASTM standards, visit the ASTM website, [www.astm.org](http://www.astm.org), or contact ASTM Customer Service at [service@astm.org](mailto:service@astm.org). For *Annual Book of ASTM Standards* volume information, refer to the standard's Document Summary page on the ASTM website.

D2661 Specification for Acrylonitrile-Butadiene-Styrene (ABS) Schedule 40 Plastic Drain, Waste, and Vent Pipe and Fittings

D2665 Specification for Poly(Vinyl Chloride) (PVC) Plastic Drain, Waste, and Vent Pipe and Fittings

### 3. Requirements

3.1 Fittings shall conform to the geometries and laying lengths as shown in Tables 1-46 and Fig. 1. Tolerances shall be  $\pm 1/16$  in. unless otherwise specified.

3.2 Spigot and hub dimensions shall conform to the requirements of the referencing standard.

3.3 The exact outside shape of a fitting is not determined by the outline drawings shown in this specification but rather by the socket dimensions, wall thickness requirements, waterway, laying lengths, and any other critical dimensions that may be specified.

3.4 The pitch of sockets for patterns with 90° angles (except vent fittings) shall be 1/4 in./ft or 1° 12 min.

3.5 On double reducing sanitary tees, the G2 dimension on branches will be calculated on the larger size and centerlines shall remain the same for both branches.

3.6 All other dimensions, materials and property requirements shall be in conformance with the referencing standard.

### 4. Keywords

4.1 DWV; fittings; plastic; Schedule 40; thermoplastic

\*A Summary of Changes section appears at the end of this standard.

TABLE 1 Bends, in. (mm)

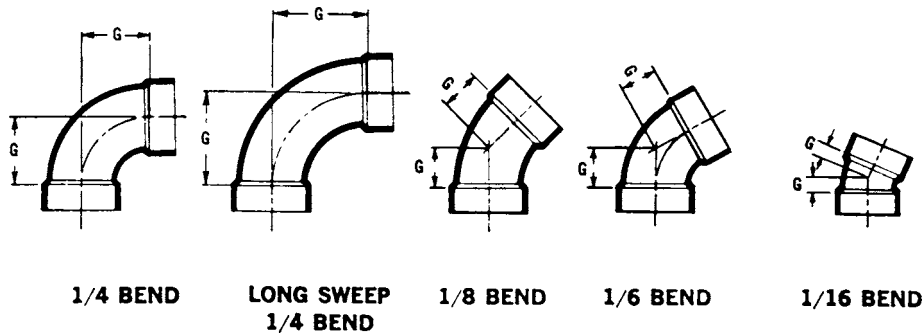

Nominal Pipe Size	1/4 Bend	Long Sweep 1/4 Bend	1/8 Bend	1/6 Bend	1/16 Bend
	G	G	G	G	G
1 1/4	1 9/16 (40)	2 1/4 (57)	1 (25)	7/8 (22)	7/16 (11)
1 1/2	1 3/4 (44)	2 3/4 (70)	1 1/8 (29)	1 (25)	1/2 (13)
2	2 5/16 (59)	3 1/4 (83)	1 1/2 (38)	1 5/16 (33)	11/16 (17)
3	3 1/16 (78)	4 1/16 (103)	1 3/4 (44)	1 11/16 (43)	1 3/16 (21)
4	3 7/8 (98)	4 15/16 (125)	2 3/16 (56)	2 1/16 (52)	1 (25)
6	5 (min) (127)	9 (229)	2 (min) (51)	3 3/8 (86)	1 1/2 (38)
8	6 (152)	...	2 1/16 (52)	...	1 1/2 (38)

TABLE 2 Bends with Inlets, in. (mm)

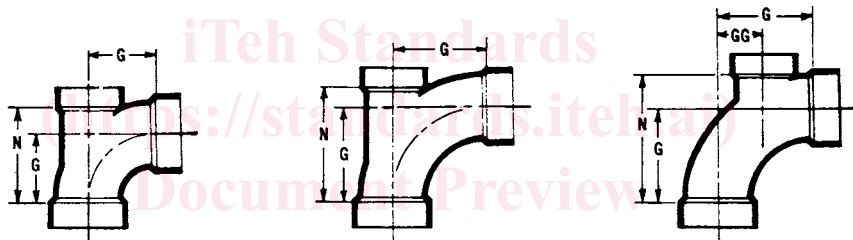

1/4 BEND With Low Heel Inlet      LONG SWEEP 1/4 BEND With Low Heel Inlet      LONG SWEEP 1/4 BEND With High Heel Inlet

Nominal Pipe Size	1/4 Bend with Low Heel Inlet		Long-Sweep 1/4 Bend with Low Heel Inlet		Long-Sweep 1/4 Bend with High Heel Inlet		
	G	N	G	N	G	N	GG
3 by 3 by 1 1/2	3 1/16 (78)	4 9/16 (106)	4 1/16 (103)	4 3/4 (121)	...	...	...
3 by 3 by 2	3 1/16 (78)	4 7/16 (113)	4 1/16 (103)	4 15/16 (125)	4 1/16 (103)	5 5/8 (143)	2 1/4 (57)
4 by 4 by 2	3 7/8 (98)	5 7/16 (138)	4 15/16 (125)	6 (152)	...	...	...

TABLE 3 Sanitary Tees, 45° Wyes, Combination Wyes and 1/8 Bends, in. (mm)

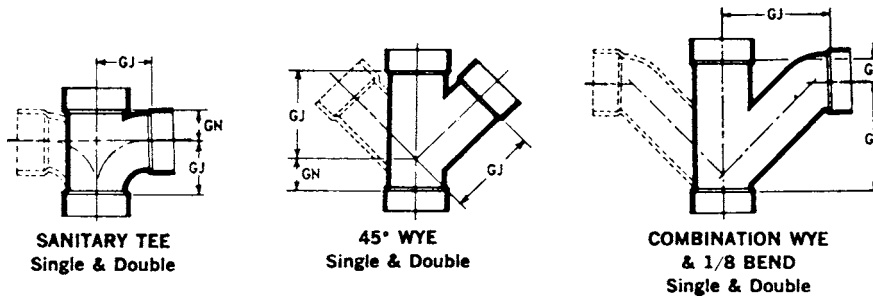

Nominal Pipe Size	Sanitary Tee Single and Double <sup>A</sup>		45° Wye, Single and Double		Combination Wye and 1/8 Bend Single and Double	
	GN	GJ	GN	GJ	GN	GJ
1/4	3/4 (19)	1 1/16 (40)	1 1/16 (27)	2 9/16 (65)	7/16 (11)	2 15/16 (75)
1 1/2	1 (25)	1 3/4 (44)	1 1/8 (29)	2 7/8 (73)	1/2 (13)	3 5/8 (86)
2	1 3/8 (35)	2 5/16 (59)	1 3/8 (35)	3 3/8 (92)	1 (25)	4 1/2 (114)
3	1 13/16 (46)	3 1/16 (78)	1 5/8 (41)	5 (127)	1 1/8 (29)	6 5/16 (160)
4	2 1/4 (57)	3 7/8 (98)	1 7/8 (48)	6 3/8 (162)	1 13/16 (46)	8 5/8 (219)
6	3 1/2 (89)	5 (127)	1 3/4 (44)	8 7/16 (214)	<sup>B</sup>	<sup>B</sup>
8	4 1/2 (114)	6 (152)	2 3/8 (60)	11 3/4 (298)	<sup>B</sup>	<sup>B</sup>

<sup>A</sup>Non-reducing double sanitary tees are for vent use only.

<sup>B</sup>Combination wye and 1/8 bend is assembled from two standard fittings.

TABLE 4 Reducing Sanitary Tees, 45° Wyes, Combination Wyes, and 1/8 Bends, in. (mm)

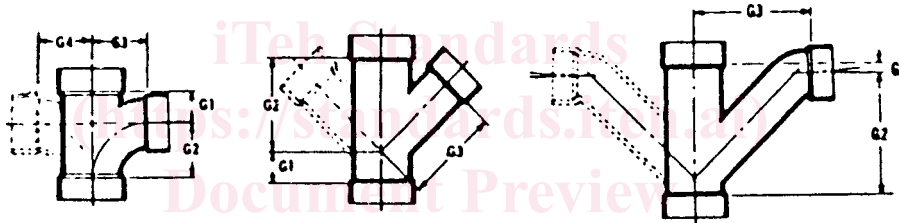

Nominal Pipe Size	Sanitary Tee, Reducing Single and Double <sup>A</sup>				45° Wye, Reducing Single and Double			Combination Wye and 1/8 Bend Reducing Single and Double		
	G1	G2	G3	G4	G1	G2	G3	G1	G2	G3
1 1/2 by 1 1/4 by 1 1/4	1 1/16 (17) <sup>B</sup>	1 1/2 (38) <sup>B</sup>	1 11/16 (43) <sup>B</sup>	1 11/16 (43) <sup>B</sup>	—	—	—	—	—	—
1 1/2 by 1 1/4 by 1 1/2	1 (25)	1 3/4 (44)	1 3/4 (44)	1 3/4 (44)	—	—	—	—	—	—
1 1/2 by 1 1/2 by 1 1/4	1 3/16 (21)	1 11/16 (43)	1 13/16 (46)	1 13/16 (46)	—	—	—	1/2 (13)	3 1/4 (83)	3 5/8 (81)
2 by 1 1/4 by 1 1/2	1 3/16 (30)	1 15/16 (49)	2 3/16 (56)	2 3/16 (56)	—	—	—	—	—	—
2 by 1 1/2 by 1 1/2	1 3/16 (30)	1 15/16 (49)	2 3/16 (56)	2 3/16 (56)	3/4 (19) <sup>B</sup>	2 13/16 (71) <sup>B</sup>	2 15/16 (75) <sup>B</sup>	9/16 (14)	3 11/16 (94)	3 5/8 (92)
2 by 1 1/2 by 2	1 3/8 (35)	2 5/16 (59)	2 5/16 (59)	2 5/16 (50)	1 (25) <sup>B</sup>	3 1/2 (89) <sup>B</sup>	3 3/8 (86) <sup>B</sup>	1 (25)	4 1/2 (114)	4 1/2 (114)
2 by 2 by 1 1/4	1 3/16 (30)	1 15/16 (49)	2 3/16 (56)	2 3/16 (56)	—	—	—	—	—	—
2 by 2 by 1 1/2	1 3/16 (30)	1 15/16 (49)	2 3/16 (56)	2 3/16 (56)	1 1/16 (27)	3 5/16 (84)	3 7/16 (87)	9/16 (14)	3 11/16 (170)	3 5/8 (92)
3 by 3 by 1 1/2	1 5/16 (24)	1 3/4 (44)	2 9/16 (65)	2 9/16 (65)	1/2 (13)	3 3/4 (95)	4 5/16 (110)	1/8 (3)	3 7/16 (87)	4 1/4 (108)
3 by 3 by 2	1 3/16 (30)	2 1/8 (54)	2 7/8 (73)	2 7/8 (73)	7/8 (22)	4 1/8 (105)	4 5/8 (117)	7/16 (11)	4 3/4 (121)	5 5/16 (135)
3 by 3 by 2 by 1 1/2	1 5/16 (24) <sup>B</sup>	2 1/16 (52) <sup>B</sup>	2 7/16 (62) <sup>B</sup>	2 1/2 (64) <sup>B</sup>	—	—	—	—	—	—
4 by 4 by 1 1/2	1 11/16 (27) <sup>B</sup>	2 (51) <sup>B</sup>	3 1/4 (83) <sup>B</sup>	3 1/4 (83) <sup>B</sup>	0 (0) <sup>B</sup>	3 5/16 (84) <sup>B</sup>	3 15/16 (100) <sup>B</sup>	—	—	—
4 by 4 by 2	1 1/8 (29)	2 1/16 (52)	3 5/16 (84)	3 5/16 (84)	3/8 (10)	4 11/16 (119)	5 9/16 (141)	5/16 (8)	4 3/4 (121)	5 7/8 (149)
4 by 4 by 3	1 3/4 (44)	3 (76)	3 9/16 (90)	3 9/16 (90)	1 1/16 (27)	5 9/16 (141)	6 (152)	1 1/16 (27)	6 3/8 (162)	6 7/8 (175)
6 by 6 by 3	—	—	—	—	3/16 (5) <sup>B</sup>	6 15/16 (176) <sup>B</sup>	7 7/16 (189) <sup>B</sup>	1 1/16 (17) <sup>B</sup>	7 13/16 (198) <sup>B</sup>	8 13/16 (224) <sup>B</sup>
6 by 6 by 4	2 3/16 (56) <sup>B</sup>	3 5/8 (92) <sup>B</sup>	4 5/16 (110) <sup>B</sup>	4 5/16 (110) <sup>B</sup>	9/16 (5) <sup>B</sup>	6 11/16 (170) <sup>B</sup>	7 7/16 (189) <sup>B</sup>	9/16 (14) <sup>B</sup>	7 13/16 (198) <sup>B</sup>	8 15/16 (227) <sup>B</sup>
8 by 8 by 4	2 5/8 (67)	4 1/8 (105)	5 1/4 (133)	5 1/4 (133)	3/8 (10)	7 5/8 (194)	8 5/8 (219)	<sup>C</sup>	<sup>C</sup>	<sup>C</sup>
8 by 8 by 6	3 3/16 (90)	4 13/16 (122)	5 1/2 (140)	5 1/2 (140)	1 (25)	9 1/2 (241)	9 13/16 (249)	<sup>C</sup>	<sup>C</sup>	<sup>C</sup>

<sup>A</sup>Non-reducing double sanitary tees are for vent use only.

<sup>B</sup>This dimension is a minimum with no upper maximum limit.

<sup>C</sup>Combination Wye and 1/8 bend is assembled from two standard fittings.

TABLE 5 60° Wyes, Single, and Double, in. (mm)

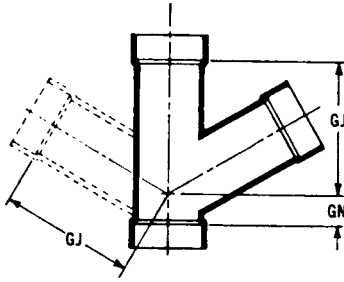

Nominal Pipe Size	GN	GJ
1½	1⅞ (40)	2⅞ (73)
2	1⅞ (37)	3⅞ (92)
3	1⅞ (37)	5 (127)

TABLE 8 60° Reducing Wyes, Single and Double, in. (mm)

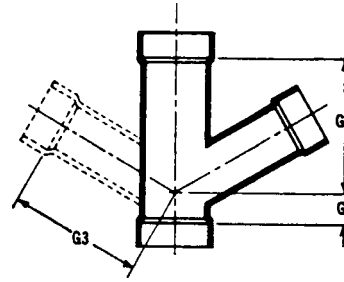

Nominal Pipe Size	G1	G2	G3
2 by 2 by 1½	1⅞ (27)	3⅞ (87)	3⅞ (87)
3 by 3 by 1½	½ (13)	3¾ (95)	4⅞ (110)
3 by 3 by 2	⅞ (22)	4⅞ (105)	4⅞ (117)

TABLE 6 Fixture Tees, in. (mm)

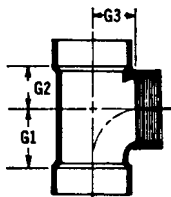

Nominal Pipe Size	G1	G2	G3
1½	1⅞ (40)	1⅞ (30)	1¼ (32)
2 by 1½ by 1½	1⅞ (37)	1⅞ (30)	1¼ (32)
2 by 2 by 1½	1⅞ (37)	1⅞ (33)	1¼ (32)

TABLE 9 Molded Nipples, in. (mm)

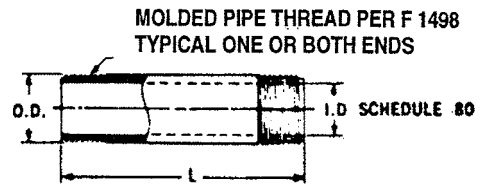

Nominal Pipe Size	OD	ID	Length
1½	1.900	1.500	½-in. increments from close to 18 in. long
2	2.375	1.939	
3	3.500	2.900	

TABLE 7 Cleanout Tees, in. (mm)

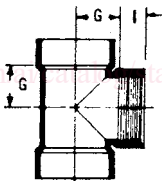

Nominal Pipe Size	G	I
1½	1⅞ (30)	⅝ (16)
2	1⅞ (38)	⅝ (16)
3	1⅞ (48)	¾ (19)
4	2½ (64)	⅞ (22)

TABLE 10 Vent Tees and ¼ Bend Vents, in. (mm)

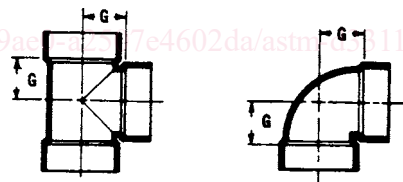

Nominal Pipe Size	Vent Tee	¼ Bend Vent
1¼	1 (25)	1 (25)
1½	1⅞ (30)	1⅞ (30)
2	1½ (38)	1½ (38)
3	1⅞ (48)	1⅞ (48)
4	2½ (64)	2½ (64)

TABLE 11 Reducing Vent Tees, Single, and Double, in. (mm)

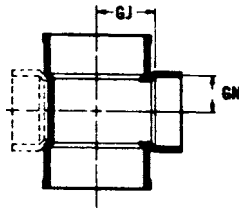

Nominal Pipe Size	GN	GJ
2 by 1½ by 1½	1⅜ (30)	1½ (38)
2 by 2 by 1½	1⅜ (30)	1½ (38)
3 by 3 by 1½	1⅜ (30)	1⅞ (48)
3 by 3 by 2	1½ (38)	1⅞ (48)

TABLE 12 Bushings, in. (mm)

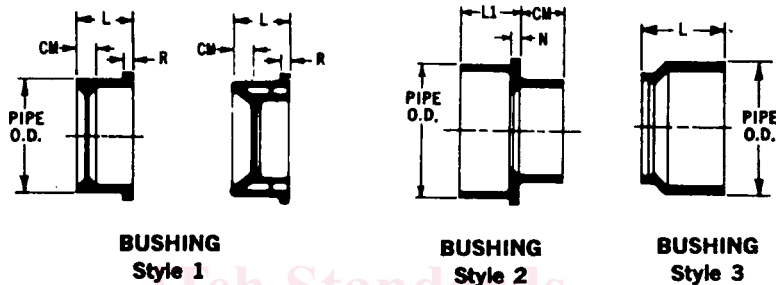

Nominal Pipe Size	Style 1 (a and b) <sup>4</sup>			Style 2		Style 3	
	L	CM	R	L1	CM	N	L
1½ by 1¼	15/16 (24)	3/16 (5)	3/16 (5)	...	...	...	1 (25)
2 by 1¼	1⅞ (27)	5/16 (8)	3/16 (5)	...	...	...	1⅞ (29)
2 by 1½	1⅞ (27)	5/16 (8)	3/16 (5)	...	...	...	1⅜ (28)
3 by 1½	1¾ (44)	1 (25)	¼ (6)	1¾ (44)	¾ (19)	¼ (6)	1½ (38)
3 by 2	1¾ (44)	7/8 (22)	¼ (6)	1¾ (44)	7/8 (22)	¼ (6)	1⅞ (41)
4 by 2	2 (51)	1⅞ (29)	¼ (6)	2 (51)	7/8 (22)	¼ (6)	...
4 by 3	2 (51)	½ (13)	¼ (6)	2 (51)	1½ (38)	¼ (6)	...
6 by 3	35/16 (84)	1⅜ (97)	5/16 (8)	...	...	...	...
6 by 4	3½ (89)	1¾ (44)	½ (13)	...	...	...	...
8 by 4	4⅞ (117)	2⅞ (73)	5/8 (16)	...	...	...	...
8 by 6	4⅞ (117)	1⅞ (41)	5/8 (16)	...	...	...	...

<sup>4</sup>No less than four ribs shall be used to support walls.

TABLE 13 Couplings, Adapters, in. (mm)

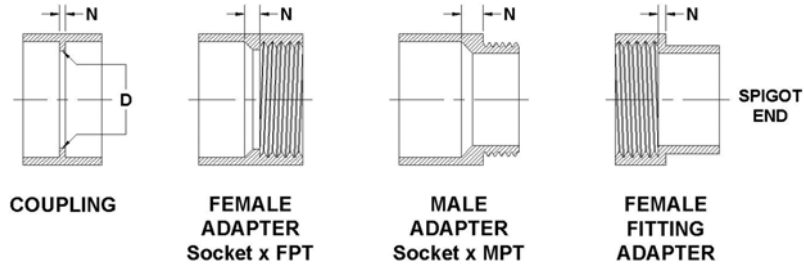

Nominal Pipe Size	Coupling		Female Adapter		Male Adapter		Female Fitting Adapter
	<i>D</i>	<i>N</i> , min	<i>N</i> , min	<i>N</i> , min	<i>A</i> , max	<i>N</i> , min	
1¼	1.600 to 1.380	⅛ (3)	¼ (6)	⅜ (5)	1.290 (32.77)	⅝ (4)	
1½	1.840 to 1.610	⅛ (3)	¼ (6)	⅜ (5)	1.552 (39.42)	⅝ (4)	
2	2.320 to 2.067	⅛ (3)	¼ (6)	⅜ (5)	2.067 (52.50)	⅝ (4)	
3	3.440 to 3.068	⅜ (5)	⅝ (8)	⅝ (10)	3.068 (77.93)	⅞ (6)	
4	4.440 to 4.026	¼ (6)	1½ (9)	⅝ (10)	4.026 (102.26)	¼ (6)	
6	6.550 to 6.065	¼ (6)	...	...	...	...	
8	8.655 to 8.610	¼ (6)	...	...	...	...	

TABLE 14 Pipe Increasers, in. (mm)



Nominal Pipe Size	<i>N</i> , min
1¼ by 1½	1⅜ (10)
1½ by 2	1⅞ (13)
1½ by 3	1⅞ (28)
2 by 3	2 (22)
2 by 4	1⅞ (35)
3 by 4	1⅞ (24)

TABLE 15 Trap Adapters, in. (mm)

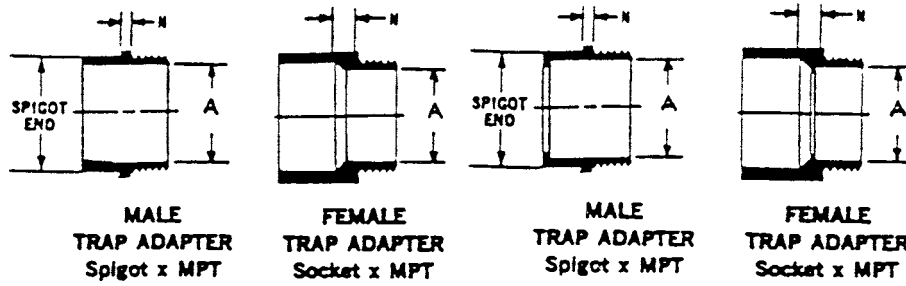

Without stop		With Stop	
Nominal Pipe Size	N, min	A, min	
1¼	¾ (5)	1.250 (32)	
1½	¾ (5)	1.500 (38)	
2	¾ (5)	2.000 (51)	
1¼ by 1½	¾ (5)	1.250 (32)	

TABLE 16 Pipe Plugs, in. (mm)

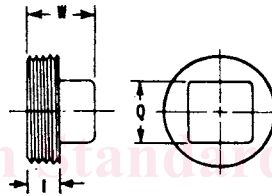

Nominal Pipe Size	L	W	Q
1¼	½ (13)	1 (25)	1 (25)
1½	5⁄8 (16)	1⅛ (35)	1 (25)
2	5⁄8 (16)	1⅛ (35)	1¼ (32)
2½	¾ (19)	1½ (38)	1¼ (32)
3	¾ (19)	1¾ (44)	1⅝ (41)
3½	¾ (19)	1¾ (44)	1⅝ (41)
4	7⁄8 (22)	1⅞ (48)	2 (51)
6	1 (25)	2 (51)	2¼ (32)
8	1⅜ (35)	2⅝ (60)	3½ (89)

TABLE 17 Hubs, in. (mm)

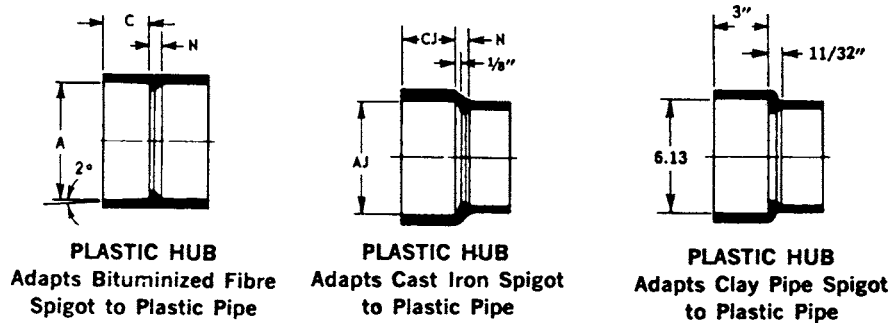

Nominal Pipe Size	A	C	N	AJ	CJ	N
2	...	...	...	2.94 (74.7)	2 <sup>3</sup> / <sub>8</sub> (60)	3 <sup>3</sup> / <sub>8</sub> (10)
3	3.448 (87.58)	1 <sup>11</sup> / <sub>16</sub> (43)	5 <sup>1</sup> / <sub>16</sub> (8)	3.94 (100.1)	2 <sup>5</sup> / <sub>8</sub> (67)	7 <sup>1</sup> / <sub>16</sub> (11)
4	4.493 (114.12)	1 <sup>15</sup> / <sub>16</sub> (49)	1 <sup>1</sup> / <sub>32</sub> (9)	4.94 (125.5)	2 <sup>7</sup> / <sub>8</sub> (73)	1 <sup>1</sup> / <sub>2</sub> (13)
Reducing 4 by 3	4.493 (114.12)	1 <sup>15</sup> / <sub>16</sub> (49)	5 <sup>1</sup> / <sub>16</sub> (8)	4.94 (125.5)	2 <sup>7</sup> / <sub>8</sub> (73)	7 <sup>1</sup> / <sub>16</sub> (11)

TABLE 18 Spigots, in. (mm)

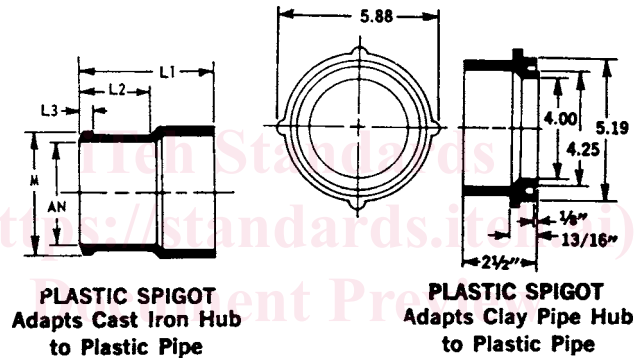

Nominal Pipe Size	L2, min	L1, min	L3, min	M		AN
				max	min	
2	3 <sup>1</sup> / <sub>2</sub> (89)	4 <sup>5</sup> / <sub>8</sub> (117)	3 <sup>1</sup> / <sub>8</sub> (10)	2.75 (69.9)	2.63 (66.8)	2.00 (50.8)
3	3 <sup>3</sup> / <sub>4</sub> (95)	5 <sup>5</sup> / <sub>8</sub> (143)	3 <sup>1</sup> / <sub>8</sub> (10)	3.88 (98.6)	3.63 (92.2)	3.00 (76.2)
4	4 (102)	6 <sup>1</sup> / <sub>8</sub> (156)	3 <sup>1</sup> / <sub>8</sub> (10)	4.88 (124.0)	4.63 (117.6)	4.00 (101.6)



TABLE 19 Reducing Spigots, in. (mm)

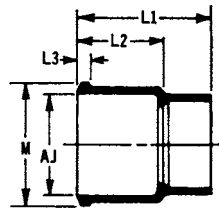

**PLASTIC SPIGOT, Reducing  
Adapts Cast Iron Hub  
to Plastic Pipe**

Nominal Pipe Size	L2 min	L1 min	L3 min	M		AJ
				max	min	
2 by 1½	3½ (89)	4¼ (108)	¾ (10)	2.75 (69.9)	2.63 (66.8)	2.00 (50.8)
3 by 1½	3¾ (95)	4½ (114)	¾ (10)	3.88 (98.6)	3.63 (92.2)	3.00 (76.2)
3 by 2	3¾ (95)	4⅝ (117)	¾ (10)	3.88 (98.6)	3.63 (92.2)	3.00 (76.2)
4 by 2	4 (102)	4⅞ (124)	¾ (10)	4.88 (124.0)	4.63 (117.6)	4.00 (101.6)
4 by 3	4 (102)	5½ (140)	¾ (10)	4.88 (124.0)	4.63 (117.6)	4.00 (101.6)

TABLE 20 P Traps, in. (mm)

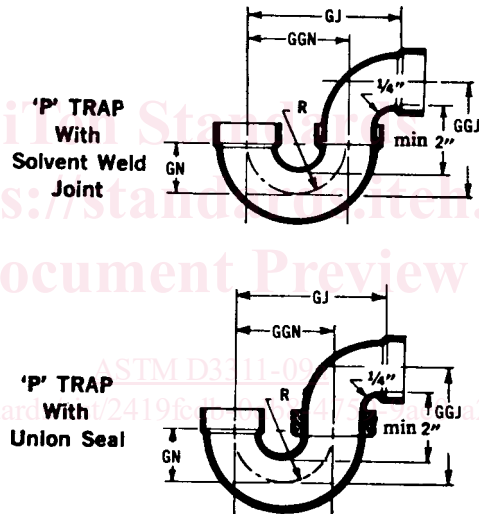

Nominal Pipe Size	min GJ	min GGJ	min GGN	min GN	min R
1¼	4⅞ (105)	3⅞ (86)	3 (76)	1⅝ (35)	1⅝ (41)
1½	4⅞ (107)	3⅞ (92)	3 (76)	1⅝ (35)	1⅝ (41)
2	7¼ (184)	4⅞ (103)	5 (127)	2¼ (57)	2½ (64)
3	8⅞ (214)	6⅞ (160)	6¼ (159)	2⅝ (67)	3⅞ (79)
4	10⅞ (275)	7⅞ (200)	8⅞ (205)	3⅞ (87)	4⅞ (103)

TABLE 21 Double Fixture Fitting, in. (mm)

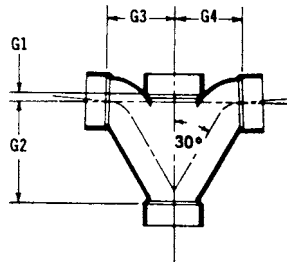

Nominal Pipe Size	G1	G2	G3	G4
1½	⅜ (10)	3⅞ (90)	2⅞ (62)	2⅞ (62)
2	⅜ (10)	4⅞ (116)	3⅞ (78)	3⅞ (78)
3	½ (13)	6¾ (171)	4½ (114)	4½ (114)
Reducing:				
2 by 1½ by 1½ by 1½	⅜ (10)	3⅞ (90)	2⅞ (62)	2⅞ (62)
2 by 1½ by 2 by 2	⅜ (10)	4⅞ (116)	3⅞ (78)	3⅞ (78)
2 by 1½ by 2 by 1½	⅜ (10)	4⅞ (116)	3⅞ (78)	3⅞ (78)

TABLE 22 Double Fixture Fitting, in. (mm)

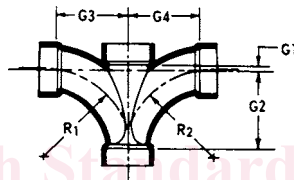

Interchanges with Double Fixture Fittings

Nominal Pipe Size	Double Fixture Fitting					
	G1	G2	G3	G4	R1	R2
1½	⅜ (10)	3⅞ (79)	2⅞ (68)	2⅞ (68)	3⅞ (92)	3⅞ (92)
2	⅜ (10)	4¼ (108)	3½ (89)	3½ (89)	4½ (114)	4½ (114)
3	½ (13)	6¼ (159)	4⅞ (125)	4⅞ (125)	6⅞ (168)	6⅞ (168)
Reducing						
2 by 1½ by 1½ by 1½	⅜ (10)	3⅞ (79)	2⅞ (73)	2⅞ (73)	3⅞ (92)	3⅞ (92)
2 by 1½ by 1½ by 2	⅜ (10)	4¼ (108)	2⅞ (73)	3½ (69)	3⅞ (92)	4½ (114)
2 by 1½ by 2 by 2	⅜ (10)	4¼ (108)	3½ (89)	3½ (89)	4½ (114)	4½ (114)
3 by 2 by 3 by 3	½ (13)	6¼ (159)	4⅞ (125)	4⅞ (125)	6⅞ (168)	6⅞ (168)