



Designation: D2990 – 09

Standard Test Methods for Tensile, Compressive, and Flexural Creep and Creep- Rupture of Plastics¹

This standard is issued under the fixed designation D2990; the number immediately following the designation indicates the year of original adoption or, in the case of revision, the year of last revision. A number in parentheses indicates the year of last reapproval. A superscript epsilon (ϵ) indicates an editorial change since the last revision or reapproval.

This standard has been approved for use by agencies of the U.S. Department of Defense.

1. Scope*

1.1 These test methods cover the determination of tensile and compressive creep and creep-rupture of plastics under specified environmental conditions (see 3.1.3).

1.2 While these test methods outline the use of three-point loading for measurement of creep in flexure, four-point loading (which is used less frequently) can also be used with the equipment and principles as outlined in Test Methods D790.

1.3 For measurements of creep-rupture, tension is the preferred stress mode because for some ductile plastics rupture does not occur in flexure or compression.

1.4 Test data obtained by these test methods are relevant and appropriate for use in engineering design.

1.5 The values stated in SI units are to be regarded as the standard. The values in parentheses are for information only.

1.6 *This standard does not purport to address all of the safety concerns, if any, associated with its use. It is the responsibility of the user of this standard to establish appropriate safety and health practices and determine the applicability of regulatory limitations prior to use.* A specific warning statement is given in 6.8.2.

NOTE 1—This standard and ISO 899 Parts 1 and 2 address the same subject matter, but differ in technical content (and results cannot be directly compared between the two test methods). ISO 899 Part 1 addresses tensile creep and creep to rupture and ISO 899 Part 2 addresses flexural creep. Compressive creep is not addressed in ISO 899.

2. Referenced Documents

2.1 ASTM Standards:²

D543 Practices for Evaluating the Resistance of Plastics to Chemical Reagents

¹ These test methods are under the jurisdiction of ASTM Committee D20 on Plastics and are the direct responsibility of Subcommittee D20.10 on Mechanical Properties.

Current edition approved Sept. 1, 2009. Published September 2009. Originally approved in 1971. Last previous edition approved in 2001 as D2990 - 01. DOI: 10.1520/D2990-09.

² For referenced ASTM standards, visit the ASTM website, www.astm.org, or contact ASTM Customer Service at service@astm.org. For *Annual Book of ASTM Standards* volume information, refer to the standard's Document Summary page on the ASTM website.

- D618 Practice for Conditioning Plastics for Testing
- D638 Test Method for Tensile Properties of Plastics
- D695 Test Method for Compressive Properties of Rigid Plastics
- D790 Test Methods for Flexural Properties of Unreinforced and Reinforced Plastics and Electrical Insulating Materials
- D1822 Test Method for Tensile-Impact Energy to Break Plastics and Electrical Insulating Materials
- D4000 Classification System for Specifying Plastic Materials
- D4065 Practice for Plastics: Dynamic Mechanical Properties: Determination and Report of Procedures
- D4968 Guide for Annual Review of Test Methods and Specifications for Plastics
- D5947 Test Methods for Physical Dimensions of Solid Plastics Specimens

3. Terminology

3.1 Definitions of Terms Specific to This Standard:

3.1.1 *creep modulus*—the ratio of initial applied stress to creep strain.

3.1.2 *creep strain*—the total strain, at any given time, produced by the applied stress during a creep test.

3.1.2.1 *Discussion*—The term creep, as used in this test method, reflects current plastics engineering usage. In scientific practice, creep is often defined to be the nonelastic portion of strain. However, this definition is not applicable to existing engineering formulas. Plastics have a wide spectrum of retardation times, and elastic portions of strain cannot be separated in practice from nonelastic. Therefore, wherever “strain” is mentioned in these test methods, it refers to the sum of elastic strain plus the additional strain with time.

3.1.3 *deformation*—a change in shape, size or position of a test specimen as a result of compression, deflection, or extension:

3.1.4 *compression*—in a compressive creep test, the decrease in length produced in the gage length of a test specimen.

3.1.5 *deflection*—in a flexural creep test, the change in mid-span position of a test specimen.

*A Summary of Changes section appears at the end of this standard

3.1.6 *extension*—in a tensile creep test, the increase in length produced in the gage length of a test specimen.

3.1.7 *slenderness ratio*—the ratio of the length of a column of uniform cross section to its least radius of gyration; for specimens of uniform rectangular cross section, the radius of gyration is 0.289 times the smaller cross-sectional dimension; for specimens of uniform circular cross section, the radius of gyration is 0.250 times the diameter.

3.1.8 *stress*—for tensile or compressive creep, the ratio of the applied load to the initial cross-sectional area; for flexural creep, maximum fiber stress is as calculated in accordance with Test Methods D790.

4. Summary of Test Methods

4.1 These test methods consist of measuring the extension or compression as a function of time and time-to-rupture, or failure of a specimen subject to constant tensile or compressive load under specified environmental conditions.

5. Significance and Use

5.1 Data from creep and creep-rupture tests are necessary to predict the creep modulus and strength of materials under long-term loads and to predict dimensional changes that may occur as a result of such loads.

5.2 Data from these test methods can be used: (1) to compare materials, (2) in the design of fabricated parts, (3) to characterize plastics for long-term performance under constant load, and (4) under certain conditions, for specification purposes.

5.3 Before proceeding with this test method, reference shall be made to the specification of the material being tested. Any specimen preparation, conditioning, dimensions, and/or testing parameters covered in the material specification shall take precedence over those mentioned in this test method, except in cases where to do so would conflict with the purpose for conducting testing. If there are no material specifications, then the default conditions apply.

6. Apparatus

6.1 Tensile Creep:

6.1.1 *Grips*—The grips and gripping technique shall be designed to minimize eccentric loading of the specimen. Swivel or universal joints shall be used beyond each end of the specimen.

6.1.2 It is recommended that grips permit the final centering of the specimen prior to applying the load. Grips that permit a displacement of the specimen within the grips during load application are not suitable.

6.2 Compressive Creep:

6.2.1 *Anvils*—Parallel anvils shall be used to apply the load to the unconfined-type specimen (see 8.2). One of the anvils of the machine shall preferably be self-aligning and shall, in order that the load be applied evenly over the face of the specimen, be arranged so that the specimen is accurately centered and the resultant load is through its center.

6.2.2 *Guide Tube*—A guide tube and fixtures shall be used when testing slender specimens (see 8.3) to prevent buckling. A suitable arrangement is shown in Fig. 1. The guide tube is a 3.2-mm (0.125-in.) Schedule 40 stainless steel pipe nipple

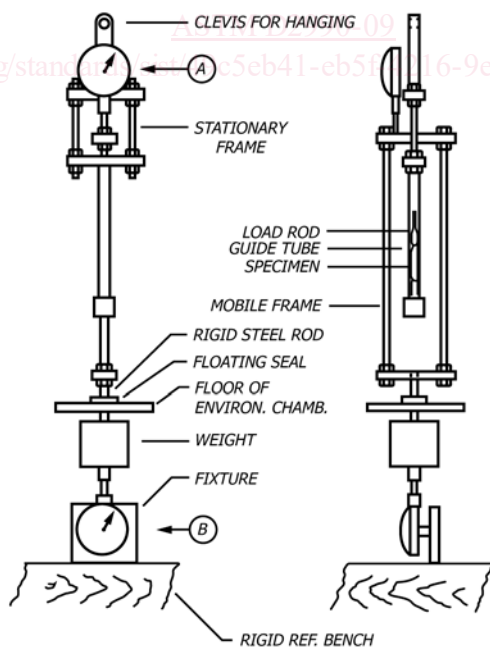

(A) LOCATION OF DIAL INDICATOR WHEN NOT USED IN ENVIRONMENTAL CHAM.
 (B) LOCATION OF DIAL INDICATOR WHEN USED IN ENVIRON. CHAMBER.

FIG. 1 A Compressive Creep Apparatus Including Details When Used in an Environmental Chamber

approximately 150 mm (6 in.) long reamed to 6.860 ± 0.025 -mm (0.270 ± 0.001 -in.) inside diameter.

6.3 Flexural Creep:

6.3.1 *Test Rack*—A rigid test rack shall be used to provide support of the specimen at both ends with a span equal to 16 (+4, -2) times the thickness of the specimen. In order to avoid excessive indentation of the specimen, the radius of the support shall be 3.2 mm (0.125 in.). Sufficient space must be allowed below the specimen for dead-weight loading at mid-span.

6.3.2 *Stirrup*—A stirrup shall be used which fits over the test specimen from which the desired load shall be suspended to provide flexural loading at mid-span. In order to prevent excessive indentation or failure due to stress concentration under the stirrup, the radius of the stirrup shall be 3.2 mm (0.125 in.). Connection between stirrup and weight shall be made in a manner to avoid nonuniform loading caused by misalignment or rack not being level.

6.3.3 A suitable arrangement is shown in Fig. 2.

6.4 *Loading System*—The loading system must be so designed that the load applied and maintained on the specimen is within $\pm 1\%$ of the desired load. The loading mechanism must allow reproductively rapid and smooth loading as specified in 11.3. In creep-rupture tests, provision must be made to ensure

that shock loading, caused by a specimen failure, is not transferred to other specimens undergoing testing.

6.4.1 Loading systems that provide a mechanical advantage require careful design to maintain constant load throughout the test. For example, lever systems must be designed so that the load does not change as the lever arm moves during the test.

6.5 Extension, Compression, and Deflection Measurement:

6.5.1 The extension or compression of specimen gage length under load shall be measured by means of any device that will not influence the specimen behavior by mechanical (undesirable deformation, notches, etc.), physical (heating of specimen, etc.), or chemical effects. Preferably the extension shall be measured directly on the specimen, rather than by grip separation. Anvil displacement may be used to measure compression. If extension measurements are made by grip separation, suitable correction factors must be determined, so that strain within the gage length can be calculated. These correction factors are dependent on the geometry of the specimen and its drawing behavior, and they must be measured with respect to these variables.

6.5.2 The deflection of the specimen at mid-span shall be measured using a dial gage (with loading springs removed, with its measuring foot resting on stirrup) or a cathetometer.

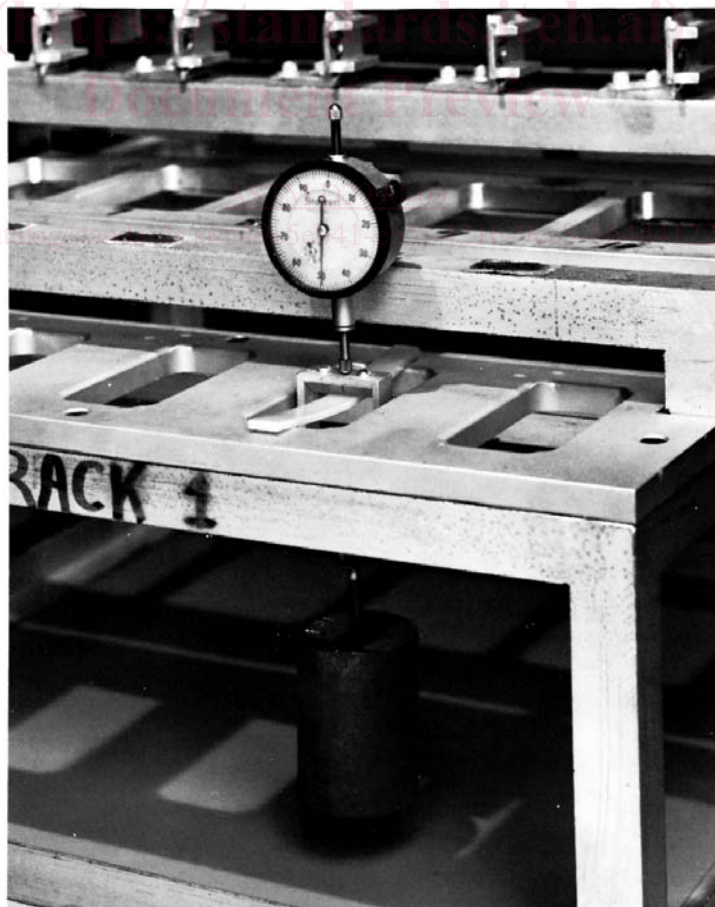

FIG. 2 Flexural Creep Test Apparatus

6.5.3 The accuracy of the deformation measuring device shall be within $\pm 1\%$ of the deformation to be measured.

6.5.4 Deformation measuring devices shall be calibrated against a precision micrometer screw or other suitable standard under conditions as nearly identical as possible with those encountered in the test. Caution is necessary when using deformation measuring devices whose calibration is subject to drifting with time and is dependent on temperature and humidity.

6.5.5 Deformation measuring devices shall be firmly attached to or seated on the specimen so that no slippage occurs. Electrical resistance gages are suitable only if the material tested will permit perfect adhesion to the specimen and if they are consistent with 6.5.1.

6.6 *Time Measurement*—The accuracy of the time measuring device shall be $\pm 1\%$ of the time-to-rupture or failure or the elapsed time of each creep measurement, or both.

6.7 *Temperature Control and Measurement:*

6.7.1 The temperature of the test space, especially close to the gage length of the specimen, shall be maintained within $\pm 2^\circ\text{C}$ by a suitable automatic device and shall be stated in reporting the results.

NOTE 2—The thermal contraction and expansion associated with small temperature changes during the test may produce changes in the apparent creep rate, especially near transition temperatures.

6.7.2 Care must be taken to ensure accurate temperature measurements over the gage length of the specimen throughout the test. The temperature measuring devices shall be checked regularly against temperature standards and shall indicate the temperature of the specimen gage area.

6.7.3 Temperature measurements shall be made at frequent intervals, or continuously recorded to ensure an accurate determination of the average test temperature and compliance with 6.7.1.

6.8 *Environmental Control and Measurement:*

6.8.1 When the test environment is air, the relative humidity shall be controlled to within $\pm 5\%$ during the test unless otherwise specified, or unless the creep behavior of the material under testing has been shown to be unaffected by humidity. The controlling and measuring instruments shall be stable for long time intervals and accurate to within $\pm 1\%$. (The control of relative humidity is known to be difficult at temperatures much outside the range of 10 to 40°C (50 to 100°F .)

6.8.2 The composition of the test environment shall be maintained constant throughout the test. (**Warning**—Safety precautions shall be taken to avoid personal contact, to eliminate toxic vapors, and to guard against explosion hazards in accordance with any possible hazardous nature of the particular environment being used.)

6.9 *Vibration Control*—Creep tests are quite sensitive to shock and vibration. The location of the apparatus, the test equipment, and mounting shall be so designated that the specimen is isolated from vibration. Multiple-station test equipment must be of sufficient rigidity so that no significant deflection occurs in the test equipment during creep or creep-rupture testing. During time-to-rupture or failure, means to

prevent jarring of other test specimens by the falling load from a failed test specimen shall be provided by a suitable net or cushion.

7. Reagents

7.1 *Purity of Reagents*—Reagent grade chemicals shall be used in all tests. Unless otherwise indicated, it is intended that all reagents shall conform to the specifications of the Committee on Analytical Reagents of the American Chemical Society, where such specifications are available.³ Other grades may be used, provided it is first ascertained that the reagent is of sufficiently high purity to permit its use without lessening the accuracy of the determination.

7.2 *Purity of Water*—Unless otherwise indicated, references to water shall be understood to mean distilled water or water of equal purity.

7.3 *Specified Reagents*—Should this test method be referenced in a material specification, the specific reagent to be used shall be as stipulated in the specification.

7.4 *Standard Reagents*—A list of standard reagents is also available in Test Method D543.

8. Test Specimens

8.1 Test specimens for tensile creep measurements shall be either Type I or Type II as specified in Test Method D638. In addition to these, specimens specified in Test Method D1822 may be used for creep-rupture testing. Tabs shall be trimmed, if necessary, to fit grips, as long as the gripping requirements in 6.1.1 are met.

8.2 Specimens for unconfined compressive creep tests shall be suitably prepared in the manner described in Test Method D695, except that the length shall be increased so that the slenderness ratio lies between 11 and 15. The standard test specimen shall be in the form of a right cylinder or prism. Preferred specimen cross sections are 12.7 by 12.7 mm (0.50 by 0.50 in.) or 12.7 mm (0.50 in.) in diameter. Surfaces of the test specimens shall be plane and parallel.

8.3 Test specimens for the compressive creep measurements, using the guide tube specified in 6.2.2, shall be slender bars of square cross section with sides measuring 4.850 ± 0.025 mm (0.191 ± 0.001 in.) and the diagonals 6.860 ± 0.025 mm (0.270 ± 0.001 in.). The specimen shall be 51 mm (2.0 in.) long with the ends machined perpendicular to the sides.

8.4 Test specimens for flexural creep measurements shall be rectangular bars conforming to the requirements of Section 5 of Test Methods D790. Preferred specimen sizes are 63.5 by 12.7 by 3.18 mm (2.5 by 0.5 by 0.125 in.) or 127 by 12.7 by 6.4 mm (5.0 by 0.5 by 0.25 in.). Close tolerances of specimen and span dimensions are not critical as long as actual dimensions are used in calculating loads.

³ "Reagent Chemicals, American Chemical Society Specifications," Am. Chemical Soc., Washington, DC. For suggestions on the testing of reagents not listed by the American Chemical Society, see "Reagent Chemicals and Standards," by Joseph Rosin, D. Van Nostrand Co., Inc., New York, NY, and the "United States Pharmacopeia."

8.5 Test specimens may be made by injection or compression molding or by machining from sheets or other fabricated forms. When the testing objective is to obtain design data, the method of sample fabrication shall be the same as that used in the application.

8.6 Specimens prepared from sheet shall be cut in the same direction. If the material is suspected to be anisotropic, a set of specimens shall be cut for testing from each of the two principal directions of the sheet.

8.7 The width and the thickness of the specimens shall be measured at room temperature with a suitable micrometer to the nearest 0.025 mm (0.001 in.) and 0.005 mm (0.0002 in.), respectively, at five or more points along the gage length or span prior to testing.

8.8 In the case of materials whose dimensions are known to change significantly due to the specified environment alone (for example, the shrinkage of some thermosetting plastics due to post-curing at elevated temperatures), provision shall be made to test unloaded control specimens alongside the test specimen so that compensation may be made for changes other than creep. A minimum of three control specimens shall be tested at each test temperature.

8.9 In creep testing at a single temperature, the minimum number of test specimens at each stress shall be two if four or more levels of stress are used or three if fewer than four levels are used.

8.10 In creep-rupture testing, a minimum of two specimens shall be tested at each of the stress levels specified in 10.2.1 at each temperature.

NOTE 3—The scatter of creep-rupture data is considerable, with one half to a full decade of variation in time-to-rupture being typical. Therefore, it may be necessary to test more than two specimens at each stress level to obtain satisfactory results.

9. Conditioning

9.1 Condition the test specimens at $23 \pm 2^\circ\text{C}$ ($73.4 \pm 3.6^\circ\text{F}$) and $50 \pm 10\%$ relative humidity for not less than 40 h prior to testing in accordance with Procedure A of Methods D618 for those tests where conditioning is required.

9.2 The specimen shall be preconditioned in the test environment for at least 48 h prior to being tested. Those materials whose creep properties are suspected to be affected by moisture content shall be brought to moisture equilibrium appropriate to the test conditions prior to testing.

10. Selection of Test Conditions

10.1 *Test Temperatures*—Selection of temperatures for creep and creep-rupture testing depends on the intended use of the test results and shall be made as follows:

10.1.1 To characterize a material, select two or more test temperatures to cover the useful temperature range, usually at elevated temperatures, in suitable increments that reflect the variation of the creep of the material with temperature and transitions of the material.

NOTE 4—A useful method for measuring the elevated-temperature response and transitions of a material for the purpose of selecting test

temperatures is Test Method D4065.

10.1.2 To obtain design data, the test temperatures and environment shall be the same as those of the intended end-use application.

10.1.3 To obtain the stress for 1 % strain at 1000 h (see 10.3.2) or for other simple material comparisons such as data sheets, select the test temperatures from the following: 23, 50, 70, 90, 120, and 155°C . These temperatures were selected from the list of standard temperatures in Practice D618.

10.2 Creep-Rupture:

10.2.1 At each test temperature, make creep-rupture tests at a minimum of seven stress levels selected so as to produce rupture at approximately the following times: 1, 10, 30, 100, 300, 1000, and 3000 h.

10.2.1.1 The objective of these tests is to produce at each test temperature, a curve of stress-at-rupture versus time-to-rupture, often called a “creep-rupture envelope,” which indicates a limit of a material’s load-bearing capability at the test temperature. For the prediction of long-term performance, for example, in the design of parts that will bear constant loads six months or longer, test times longer than 3000 h are usually necessary, particularly at elevated temperatures where heat aging of the material may be occurring, and in aggressive environments, both of which can greatly affect creep-rupture.

10.2.2 For materials that fail catastrophically (that is, with negligible yielding, drawing, or flowing) measure and report the time-to-rupture. For materials that yield, draw, or flow significantly prior to rupture, measure and report the time at the onset of tertiary creep (onset of yielding, flowing, or drawing) shall be considered the time-to-failure and shall be measured and reported. For materials that yield, draw, or flow, creep strain will have to be measured with a recorder.

10.3 Creep:

10.3.1 To obtain design data or to characterize a material, select stress levels as follows:

10.3.1.1 For materials that show linear viscoelasticity, that is, successive creep modulus versus time for different stresses that superimpose upon each other (Boltzman superposition principle (1)),⁴ select a minimum of three stress levels for each temperature of interest.

10.3.1.2 For materials that are significantly affected by stress, select at least five stresses (and preferably more) for each temperature of interest.

10.3.1.3 Select stress levels in approximately even increments up to the 1000-h creep-rupture stress:

Stress levels above 7 MPa (1000 psi) to the nearest 3.5 MPa (500 psi);

Stress levels below 7 MPa (1000 psi) to the nearest 0.7 MPa (100 psi).

10.3.1.4 Do not use stress levels that produce failure in less than 1000 h in creep testing.

10.3.2 For simple material comparisons, as for data sheets and the like, determine the stress to produce 1 % strain in 1000 h. Do this by selecting several loads to produce strains in the

⁴ The boldface numbers in parentheses refer to a list of references at the end of this standard.

approximate range of 1 % (both somewhat greater and less than 1 % in 1000 h) and plotting a 1000-h isochronous stress-strain curve from which the stress to produce 1 % strain shall be determined by interpolation.

NOTE 5—Isochronous stress-strain curves are cartesian plots of the applied stress used in the creep test versus the creep strain at a specific time, in this case 1000 h. Since only one point of an isochronous plot is obtained from each creep test, it is usually necessary to run creep tests at least three stress levels (and preferably more) to obtain an isochronous plot (Fig. 3).

11. Procedure

11.1 Mount a properly conditioned and measured specimen in the grips, compressive creep fixture, or flexural creep rack. If necessary, mount a properly conditioned and measured control specimen alongside the test specimen in the same manner.

11.2 Attach the deformation measuring devices to the specimen (and control specimen) or, if these are optical devices, install ready for measurements. Make the initial or reference measurement for extension or deflection.

11.2.1 If the test environment would be disturbed during the attachment of the deformation measuring device, mount the device prior to mounting the specimen.

11.3 Apply the full load rapidly and smoothly to the specimen, preferably in 1 to 5 s. In no case shall the loading time exceed 5 s. Start the timing at the onset of loading.

11.4 If an environmental agent is used, apply it to the entire gage length of the specimen immediately after loading.

11.4.1 If the environmental agent is volatile, cover the specimen to retard evaporation without affecting the applied load. Replenish volatile agents periodically.

NOTE 6—For liquid environmental agents a cotton swab, film, or other device may be wrapped or sealed around the gage length or span of the specimen, and the liquid agent applied to saturate the swab.

11.5 Measure the extension or compression of the specimen in accordance with the following approximate time schedule: 1, 6, 12, and 30 min; 1, 2, 5, 20, 50, 100, 200, 500, 700, and 1000 h. For creep tests longer than 1000 h, measure deformation at least monthly.

11.5.1 If discontinuities in the creep strain versus time plot are suspected or encountered, readings shall be taken more frequently than scheduled above.

11.6 Measure temperature, relative humidity, and other environmental variables and deformation of control specimen in accordance with the same schedule as that for deformation of the test specimen.

11.7 Upon completion of the test interval without rupture, remove the load rapidly and smoothly.

NOTE 7—If desired, measurements of the recovery can be initiated on the same schedule as used in 11.5 during the load application. Calculate recovery strain as described in 12.2.

12. Calculation

12.1 For tensile or compressive measurements, calculate the stresses for each specimen in megapascals (or pounds-force per square inch) by dividing the load by the average initial cross-sectional area of the reduced section.

12.1.1 For flexural measurements, calculate the maximum fiber stress for each specimen in megapascals (or pounds-force per square inch) as follows:

$$S = 3PL/2bd^2$$

where:

- S = stress, MPa (psi),
- P = load, N (lbf),
- L = span, mm (in.),
- b = width, mm (in.), and
- d = depth, mm (in.).

12.2 For tensile or compressive measurements, calculate strain by dividing the extension or compression at the times specified in 11.5 by the initial gage length of the conditioned specimen; multiply strain by 100 to obtain percent strain.

12.2.1 For flexural measurements, calculate the maximum strain in the outer fiber at the mid-span as follows:

$$r = 6D d/L^2$$

where:

- r = maximum strain, mm/mm (in./in.),
- D = maximum deflection at mid-span, mm (in.),

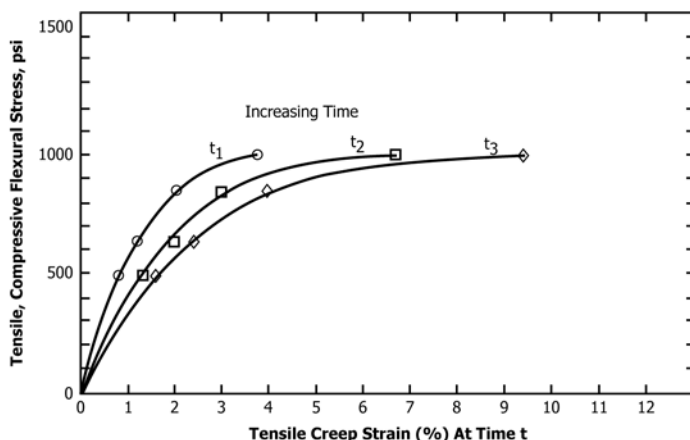

FIG. 3 Cartesian Isochronous Stress Strain Curves at Various Times

d = depth, mm (in.), and
 L = span, mm (in.).

Multiply strain by 100 to obtain percent strain.

12.3 When a material shows a significant dimensional change due to the environment alone, either of the following approaches shall be used, depending on the intended use of the results:

12.3.1 Correct each measurement of deformation under load by the algebraic addition to it of the average deformation measured on three nonloaded control specimens at the same time and at the same temperature. Contraction of the control specimens used for tensile measurements shall be considered positive (+); expansion shall be considered negative (-). Contraction of the control specimens used for compressive measurements shall be considered negative (-), expansion positive (+). Upward deflection of the control specimens used for flexural measurements shall be considered positive (+); downward shall be considered negative (-). Calculate corrected strain using the deformation corrected for dimensional change due to the environment. Multiply corrected strain by 100 to obtain percent corrected strain.

12.3.2 If, because of the intended use of the results, it is desired not to correct the deformation under load for significant dimensional change due to the environment alone, then the strain calculated in accordance with 12.2 or 12.2.1 shall be called uncorrected strain. Calculate the strain change due to the environment in accordance with 12.2 or 12.2.1 by using the average deformation in the control specimen. Multiply by 100 to obtain percent strain change due to the environment. Contraction of the control specimens used for tensile measurements shall be considered positive (+), expansive negative (-). Contraction of the control specimens used for compressive measurements shall be considered negative (-), expansion positive (+). Upward deflection of the control specimens used for flexural measurements shall be considered positive (+), downward negative (-).

12.4 Calculate creep modulus in megapascals (or pounds-force per square inch) by dividing the initial stress by the strain at the times specified in 11.5.

NOTE 8—For purposes of comparing materials, the plot of creep modulus versus time not only realistically ranks materials but also provides modulus values for use in many design equations (see Fig. 4).

12.5 At each test temperature, calculate a statistical least squares regression equation of log stress versus log time-to-rupture or failure. From the regression equation calculate the stress-to-rupture or failure in megapascals (or pounds-force per square inch) at 1000 h (see Fig. 5).

12.6 To calculate the stress to produce 1 % strain at 1000 h, plot at each test temperature the 1000-h isochronous stress-strain curve (see Fig. 3) and interpolate for the stress at 1 % strain. The isochronous stress-strain curve at 1000 h is obtained from several (at least three, and preferably more) creep curves at different stresses by plotting stress versus strain calculated from deformation measurements at 1000 h.

12.6.1 Isochronous stress-strain curves may be plotted at times other than 1000 h for purposes of analysis or for specialized design situations involving relatively short-time loads and materials that show pronounced creep at such times. For long-term loading and in general, however, creep modulus curves are more useful.

13. Report

13.1 Report the following information:

13.1.1 Description of the material tested, including all pertinent information on composition, preparation, manufacturer, trade name, code number, date of manufacture, type of molding, annealing, etc.,

13.1.2 Dates of the creep test,

13.1.3 Dimensions of the test specimen,

13.1.4 Test method number and revision date, and

13.1.5 Preconditioning used and description of test conditions, including the relative humidity, temperatures, as well as concentration and composition of the environment other than air, loads used, type loading, etc.

13.2 For each test temperature, plot log strain in percent versus log time in hours under load with stress as a parameter (see Fig. 6).

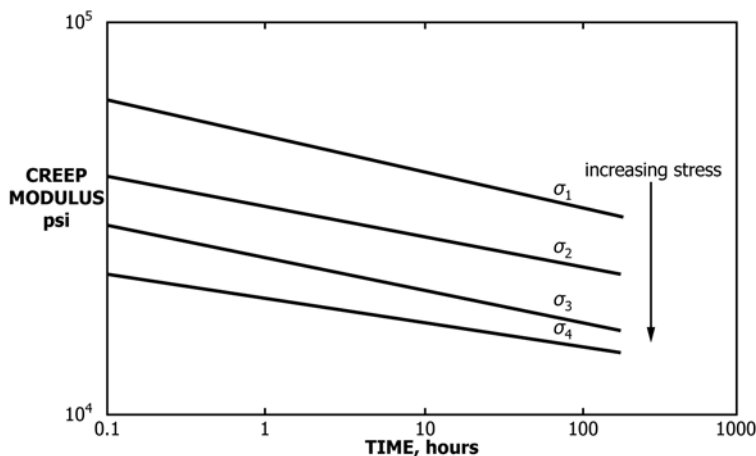

FIG. 4 Logarithmic Creep Modulus Versus Time Curves at Various Stress Levels

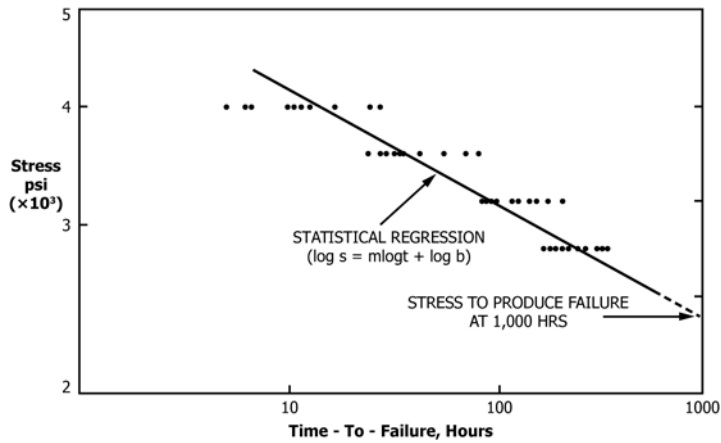

FIG. 5 Logarithmic Time-to-Failure (Stress Rupture) Curve

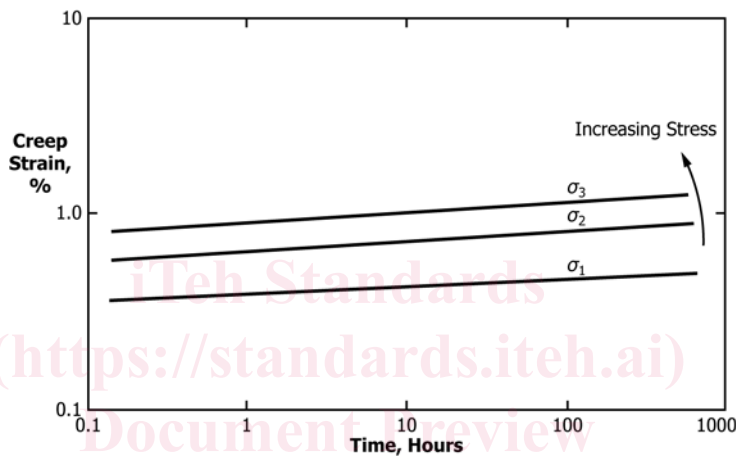

FIG. 6 Logarithmic Creep Strain Versus Time Curves at Various Stress Levels

13.2.1 Where deformation measurements of loaded specimens have been corrected from unloaded control specimens, plot log corrected strain (in percent) versus log time (in hours) under load, and on the same graph also plot the log average dimensional change (in percent) due to the environment alone versus log time.

13.2.2 Where significant changes in deformation due to the environment alone have occurred, but because of the intended use of the results it is desired not to correct the deformation under load, then plot log uncorrected strain, in percent, versus log time in hours under load, and on the same graph plot the log average strain change (in percent) of the control specimen versus log time.

13.2.3 When a material shows a significant dimensional change due to the environment alone, any properties calculated from the creep data (such as creep modulus or isochronous stress-strain curves) shall be labeled corrected or uncorrected, depending on which approach is used.

14. Precision and Bias

14.1 Attempts to develop a precision and bias statement for these test methods have not been successful. For this reason, data on precision and bias cannot be given. Anyone wishing to participate in the development of precision and bias data should contact the Chairman, Subcommittee D20.10 (Section D20.10.24), ASTM, 100 Barr Harbor Drive, West Conshohocken, PA 19428-2959.

NOTE 9—Precision data in the previous edition of these test methods have been judged to be invalid because they were based on round robins which yielded insufficient data. The available within-laboratory data provided only two to six total degrees of freedom, and between-laboratory data were based on only two to four laboratories.

14.2 There are no recognized standards for measuring bias in regard to these test methods.

15. Keywords

15.1 creep; creep-rupture; plastics

APPENDIXES

(Nonmandatory Information)

X1. INTRODUCTION

X1.1 Since the properties of viscoelastic materials are dependent on time-, temperature-, and rate-of-loading, an instantaneous test result cannot be expected to show how a material will behave when subjected to stress or deformation

for an extended period of time. Therefore, values of modulus and strength should be obtained under conditions (stress, time, and so forth) that simulate the end-use application, and can be used in engineering design.

X2. CREEP CURVE

X2.1 The creep test measures the dimensional changes that occur during time under a constant static load, while the creep rupture test measures the time to break under a constant load. Creep is the progressive deformation of a material at constant load (stress). A constant load is applied to a specimen in selected loading configurations, (such as, tension, flexure, or compression) at constant temperature and the deformation is measured as a function of time.

X2.2 Following an initial rapid elongation (ϵ_o) upon application of the load (ϵ_o may be considered to consist of the elastic (ϵ_e) and the plastic (ϵ_p)), the following occurs:

X2.2.1 The creep rate decreases rapidly with time, (primary creep, Stage I), then

X2.2.2 It reaches a steady-state value (secondary creep, Stage II), followed by

X2.2.3 A rapid increase and fracture (tertiary creep, Stage III).

NOTE X2.1—This is an idealized curve. Some materials do not have a secondary stage, while tertiary creep usually occurs at high stresses and for ductile materials.

NOTE X2.2—Since the specimen elongates and decreases in cross-sectional area, the axial stress increases. Therefore, in a constant-load creep test the onset of Stage III shows up earlier than in a constant-stress test (see dotted line in Fig. X2.1)

NOTE X2.3—In some terminologies the instantaneous strain (ϵ_o) is often called the first stage, in which case we have four stages of creep.

X2.3 The strain, shown as ϵ_o , occurs instantaneously upon application of the load. Even though the applied stress is below the yield stress, some of this strain is not totally recoverable. Although this strain is not really creep it is very important since it constitutes a considerable fraction of the allowable total strain in designing. Therefore, it should be included in all calculations, especially of the creep modulus.

NOTE X2.4—In cases where this instantaneous strain is subtracted from the total strain, the creep curve must start at the origin of the time/strain coordinates.

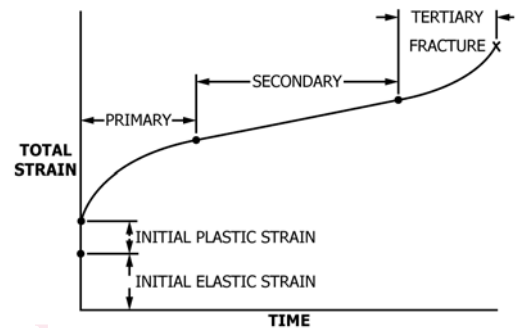

NOTE 1—The segregation of creep data into instantaneous, primary, and secondary stages is dependent upon the time scale of the plot.

NOTE 2—The parameters, ϵ_e , ϵ_p , and ϵ_o are not obtainable using these test methods (see Note 5). However, such factors may be separately defined for the sake of stress analysis. Any such definitions can be more or less arbitrary with respect to the time-dependent material behavior.

FIG. X2.1 Creep Curve

X2.4 Due to the long times involved, creep curves are usually plotted on logarithmic scales where the data is generally linear. The three curves shown in Fig. X2.2, Fig. X2.3, and Fig. X2.4 are an example.

X2.5 As the stress levels increase the creep modulus will be lowered.

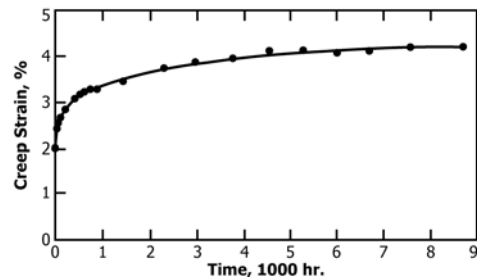
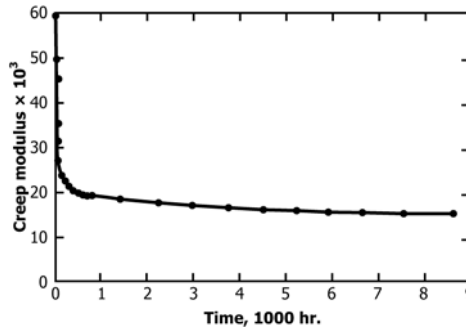

FIG. X2.2 Tensile-Creep Curve of PTFE at 650 psi, 23°C Creep Strain versus Time



NOTE 1—(Modulus = Applied Stress/Total Creep Strain)

FIG. X2.3 Creep Modulus versus Time

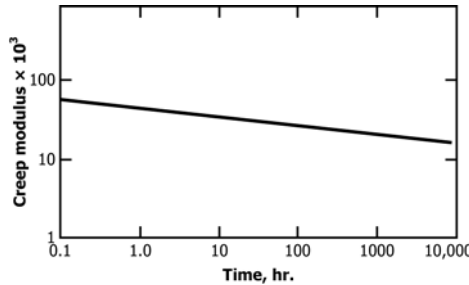

FIG. X2.4 Creep Modulus versus Time on Logarithmic Coordinates

X3. CREEP STRENGTH AND CREEP RUPTURE

X3.1 In reporting strength data we often speak of creep strength and rupture strength (creep rupture).

X3.2 The minimum creep rate (slope d_E/dt) is one of the important parameters. A condition (for example, for jet-engine material) is the stress needed to produce a creep rate of 0.0001 % E/h or 1 % E/10 000 h. Fig. X3.1 illustrates the importance of the creep rate.

X3.3 *Creep strength* is defined as the stress at a given temperature that produces a steady creep rate of a fixed amount in percent per hour. (See Fig. X3.2.)

X3.4 *Rupture strength* is defined as the stress at a given temperature to produce rupture in a fixed amount of time in hours. (See Fig. X3.3.)

X3.5 The stress-rupture test is basically similar to a creep test with the exception that it is continued until the material fails. Since higher loads are used, creep rates are higher and the



FIG. X3.2 Creep Strength

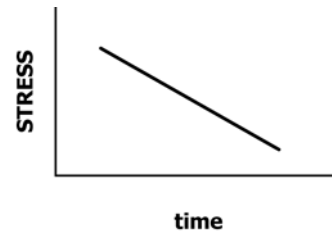

FIG. X3.3 Rupture Strength

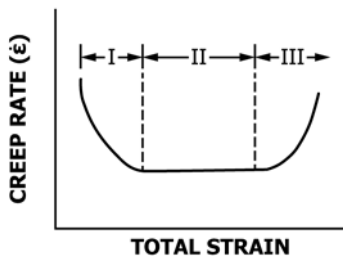

FIG. X3.1 Creep Rate

material fails in a shorter time (usually terminated in 1000 h). This test is useful in establishing a safe envelope inside which a creep test can be conducted. The basic information obtained from the stress-rupture test is the time-to-failure at a given stress. Based on this data, a safe stress can be determined below which it is safe to operate, given the time requirements of the end-use application. The construction of the creep rupture envelope is shown in Fig. X3.4. Strain is plotted as a function of time at different stress levels by connecting the rupture points (before establishing the rupture point remember