



Standard Test Method for Determination of Fire and Thermal Parameters of Materials, Products, and Systems Using an Intermediate Scale Calorimeter (ICAL)¹

This standard is issued under the fixed designation E1623; the number immediately following the designation indicates the year of original adoption or, in the case of revision, the year of last revision. A number in parentheses indicates the year of last reapproval. A superscript epsilon (ϵ) indicates an editorial change since the last revision or reapproval.

1. Scope

1.1 This fire-test-response standard assesses the response of materials, products, and assemblies to controlled levels of radiant heat exposure with or without an external ignitor.

1.2 The fire-test-response characteristics determined by this test method include the ignitability, heat release rates, mass loss rates, visible smoke development, and gas release of materials, products, and assemblies under well ventilated conditions.

1.3 This test method is also suitable for determining many of the parameters or values needed as input for computer fire models. Examples of these values include effective heat of combustion, surface temperature, ignition temperature, and emissivity.

1.4 This test method is also intended to provide information about other fire parameters such as thermal conductivity, specific heat, radiative and convective heat transfer coefficients, flame radiation factor, air entrainment rates, flame temperatures, minimum surface temperatures for upward and downward flame spread, heat of gasification, nondimensional heat of gasification (**1**)² and the Φ flame spread parameter (see Test Method E1321). While some studies have indicated that this test method is suitable for determining these fire parameters, insufficient testing and research have been done to justify inclusion of the corresponding testing and calculating procedures.

1.5 The heat release rate is determined by the principle of oxygen consumption calorimetry, via measurement of the oxygen consumption as determined by the oxygen concentration and flow rate in the exhaust product stream (exhaust duct).

¹ This test method is under the jurisdiction of ASTM Committee E05 on Fire Standards and is the direct responsibility of Subcommittee E05.21 on Smoke and Combustion Products.

Current edition approved Oct. 1, 2009. Published October 2009. Originally approved in 1994. Last previous edition approved in 2004 as E1623 - 04. DOI: 10.1520/E1623-09.

² The boldface numbers given in parentheses refer to the list of references at the end of this standard.

The procedure is specified in 11.1. Smoke development is quantified by measuring the obscuration of light by the combustion product stream (exhaust duct).

1.6 Specimens are exposed to a constant heating flux in the range of 0 to 50 kW/m² in a vertical orientation. Hot wires are used to ignite the combustible vapors from the specimen during the ignition and heat release tests. The assessment of the parameters associated with flame spread requires the use of line burners instead of hot wire ignitors.

1.6.1 Heat release measurements at low heat flux levels (< 10 kW/m²) require special considerations as described in Section A1.1.6.

1.7 This test method has been developed for evaluations, design, or research and development of materials, products, or assemblies, for mathematical fire modeling, or for research and development. The specimen shall be tested in thicknesses and configurations representative of actual end product or system uses.

1.8 Limitations of the test method are listed in Section 5.5.

1.9 The values stated in SI units are to be regarded as standard. No other units of measurement are included in this standard.

1.10 *This standard is used to measure and describe the response of materials, products, or assemblies to heat and flame under controlled conditions, but does not by itself incorporate all factors required for fire hazard or fire risk assessment of the materials, products, or assemblies under actual fire conditions.*

1.11 *Fire testing is inherently hazardous. Adequate safeguards for personnel and property shall be employed in conducting these tests. Specific information about hazards is given in Section 7.*

1.12 *This standard does not purport to address all of the safety concerns, if any, associated with its use. It is the responsibility of the user of this standard to establish appropriate safety and health practices and determine the applicability of regulatory limitations prior to use.*

2. Referenced Documents

2.1 ASTM Standards:³

D5865 Test Method for Gross Calorific Value of Coal and Coke

E84 Test Method for Surface Burning Characteristics of Building Materials

E176 Terminology of Fire Standards

E662 Test Method for Specific Optical Density of Smoke Generated by Solid Materials

E691 Practice for Conducting an Interlaboratory Study to Determine the Precision of a Test Method

E800 Guide for Measurement of Gases Present or Generated During Fires

E906 Test Method for Heat and Visible Smoke Release Rates for Materials and Products Using a Thermopile Method

E1321 Test Method for Determining Material Ignition and Flame Spread Properties

E1354 Test Method for Heat and Visible Smoke Release Rates for Materials and Products Using an Oxygen Consumption Calorimeter

2.2 ASTM Proposal:

P147 Proposed Method for Room Fire Tests of Wall and Ceiling Materials and Assemblies⁴

2.3 ISO Standards:

ISO 5657-1986(E) Fire Tests—Reaction to Fire—Ignitability of Building Materials⁵

ISO 5660-1 Fire Tests—Reaction to Fire—Rate of Heat Release from Building Products⁵

ISO 5725 Precision of Test Methods—Determination of Repeatability and Reproducibility for a Standard Test Method by Inter-Laboratory Tests⁵

ISO 9705 Full Scale Room Test for Surface Products⁵

3. Terminology

3.1 Definitions:

3.1.1 For definitions of terms used in this test method, refer to Terminology **E176**.

3.1.2 *effective heat of combustion, n*—the amount of heat generated per unit mass lost by a material, product, or assembly, when exposed to specific fire test conditions. (see gross heat of combustion).

3.1.2.1 *Discussion*—The effective heat of combustion depends on the test method and is determined by dividing the measured heat release by the mass loss during a specified period of time under the specified test conditions. Typically, the specified fire test conditions are provided by the specifications of the fire test standard that cites effective heat of combustion as a quantity to be measured. For certain fire test conditions, involving very high heat and high oxygen concentrations under high pressure, the effective heat of combustion will approxi-

mate the gross heat of combustion. More often, the fire test conditions will represent or approximate certain real fire exposure conditions, and the effective heat of combustion is the appropriate measure. Typical units are kJ/g or MJ/kg.

3.1.3 *oxygen consumption principle, n*—the expression of the relationship between the mass of oxygen consumed during combustion and the heat released.

3.1.4 *smoke obscuration, n*—reduction of light transmission by smoke, as measured by light attenuation.

3.2 Definitions of Terms Specific to This Standard:

3.2.1 *emissivity, n*—the ratio of the power per unit area radiated from a material's surface to that radiated from a black body at the same temperature.

3.2.2 *heat release rate, n*—the heat evolved from the specimen, per unit of time and area.

3.2.2.1 *Discussion*—Heat release is measured in this test method both as a quantity per unit time and as a quantity per unit time and unit area.

3.2.3 *heating flux, n*—the incident flux imposed externally from the heater on the specimen at the initiation of the test.

3.2.3.1 *Discussion*—The specimen, once ignited, is also heated by its own flame.

3.2.4 *ignitability, n*—the propensity to ignition, as measured by the time to sustained flaming, in seconds, at a specified heating flux.

3.2.5 *net heat of combustion, n*—the oxygen bomb (see Test Method **D5865**) value for the heat of combustion, corrected for gaseous state of product water.

3.2.6 *orientation, n*—the plane in which the exposed face of the specimen is located during testing, either vertical or horizontal facing up.

3.2.7 *sustained flaming, n*—existence of flame on or over most of the specimen surface for periods of at least 5 s.

3.2.7.1 *Discussion*—Flaming of less than 5 s duration is identified as flashing or transitory flaming.

3.2.8 *time to sustained flaming on the exposed side, n*—time to ignition, in s.

3.2.9 *time to sustained flaming on the unexposed side, n*—test duration, in s.

4. Summary of Test Method

4.1 This is a test method designed to measure the rate of heat release from a specimen 1 m² in a vertical orientation. The specimen is exposed to a uniform heat flux from a gas fired radiant panel up to 50 kW/m² and ignited instantly. Heat release measured by this test method is based on the observation that, generally, the net heat of combustion is directly related to the amount of oxygen required for combustion (**2, 3**). The primary measurements of oxygen concentrations and exhaust flow are made as specified by Huggett (**3**). Tests are conducted with or without piloted ignition. Piloted ignition results from applying wire igniters at the top and bottom of the test specimen.

4.2 Additional measurements include the mass-loss rate of the specimen, surface temperature, the time to sustained flaming and the specimen's interior temperatures.

4.3 The apparatus is suitable to develop data associated with the parameters discussed in **1.4**.

³ For referenced ASTM standards, visit the ASTM website, www.astm.org, or contact ASTM Customer Service at service@astm.org. For *Annual Book of ASTM Standards* volume information, refer to the standard's Document Summary page on the ASTM website.

⁴ Discontinued; see 1983 *Annual Book of ASTM Standards*, Vol 04.07.

⁵ Available from American National Standards Institute (ANSI), 25 W. 43rd St., 4th Floor, New York, NY 10036.

5. Significance and Use

5.1 This test method is used primarily to determine the heat release rate of materials, products, and assemblies. Other parameters are the effective heat of combustion, mass loss rate, the time to ignition, smoke and gas production, emissivity, and surface temperature. Examples of test specimens are assemblies of materials or products that are tested in their end-use thickness. Therefore, the test method is suitable for assessing the heat release rate of a wall assembly.

5.2 Representative joints and other characteristics of an assembly shall be included in a specimen when these details are part of normal design.

5.3 This test method is applicable to end-use products not having an ideally planar external surface. The radiant flux field shall be adjusted to be that which is desired at the average distance of the surface from the radiant panel.

5.4 In this procedure, the specimens are subjected to one or more specific sets of laboratory test conditions. If different test conditions are substituted or the end-use conditions are changed, it is not always possible by or from this test to predict changes in the fire-test-response characteristics measured. Therefore, the results are valid only for the fire test exposure conditions described in this procedure.

5.5 Test Limitations:

5.5.1 The test results have limited validity if: (a) the specimen melts sufficiently to overflow the drip tray, or (b) explosive spalling occurs.

5.5.2 Exercise caution in interpreting results of specimens that sag, deform, or delaminate during a test. Report observations of such behavior.

6. Apparatus

6.1 General:

6.1.1 Where dimensions are stated in the following description, they shall be considered mandatory and shall be followed within nominal tolerance of ± 5 mm on the radiant panel and specimen holder assemblies. An exception to this tolerance is the placement of the screen in front of the ceramic burner that shall be ± 0.5 mm. The tolerances permitted in the exhaust system (see Proposal P147) for the proposed room fire test method or the **ISO 9705** standard are permissible.

6.1.2 The apparatus shall consist of the following components: a radiant panel assembly (see **Fig. 1**) capable of vertical orientation only; a specimen holder (see **Fig. 2**), an infrared pyrometer (optional), an exhaust collection system, weighing platform, gas meter, and a data acquisition system. A general layout of the whole test assembly is shown in **Fig. 3**.

6.2 Radiant Panels:

6.2.1 The panel consists of a hollow 50 by 50 mm square steel tubing (see **Fig. 1**) that supports three rows of adjustable, ceramic-faced, natural gas burners⁶ comprised of three burners per row. The tubing has typical residential water hose connections provided at the bottom of the tubing to facilitate water cooling.

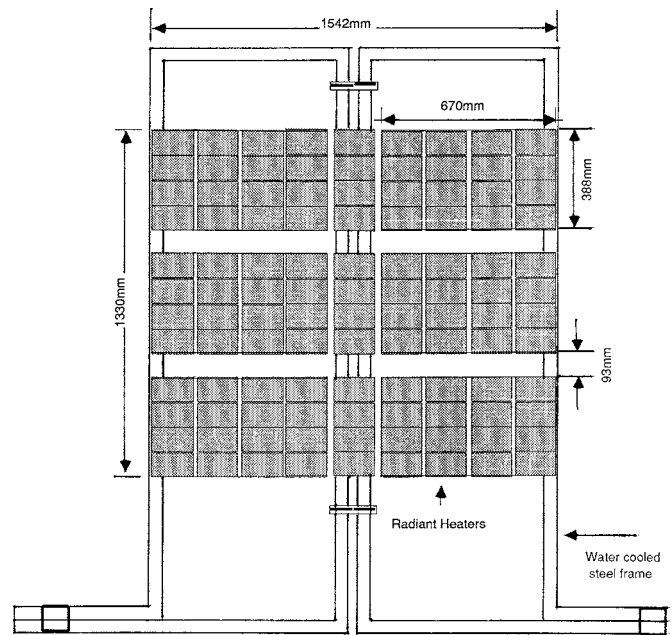

FIG. 1 Radiant Panel Assembly

6.2.2 The left and right burners in each row are made up of four modules each and the center burners are comprised of one module. A module consists of four vertically stacked ceramic elements 12.7 mm deep by 95 mm high by 158 mm wide. The center burners consist of one module each. The modules are comprised of a plenum space in which the natural gas is injected at a controlled rate by the burner's control system. Combustion air is aspirated into the plenum space through the gas and air injection port.

6.2.3 The face of each burner is covered with stainless 330 floating screen for higher surface temperature and safety. The screens shall be carefully installed to allow for elongation of screens and supporting rods. This will allow the distance between the burners and screens to remain constant when heated. The optimum distance between the surface of the burners and the outer surface of the screen was found to be 20 mm. The rows of gas burners on the panel shall be separated by a distance of 112 mm from each other and shall be attached to the support tubing at the locations indicated in **Fig. 1**.

6.2.4 Natural gas of net heating value at least 790 kJ/mol shall be supplied to the unit through a control system provided with as safety interlock. All gas pipe connections to the burners must be sealed with a gas pipe compound resistant to liquified petroleum gases. A drip leg shall be installed in the gas supply line going to each heater to minimize the possibility of any loose scale or dirt within the gas supply line from entering the burner's control system.

6.2.5 Ignition of the burners shall be accomplished by individual, automatic spark igniters and pilot flames. The spark igniters are used to ignite the pilot flames which in turn are used to ignite the burners after pilot flame temperature sensors have reached a required value. The pilot remains on until the burners are extinguished.

6.2.6 An opening of at least 25 mm shall be provided at the vertical centerline between the rows of burners.

⁶ A modified RAY-TEC burner unit, RT132, from Sun Technology Corp., 14329 23 Mile Road, Shelby TWP., MI 48315 has been found suitable for this application.

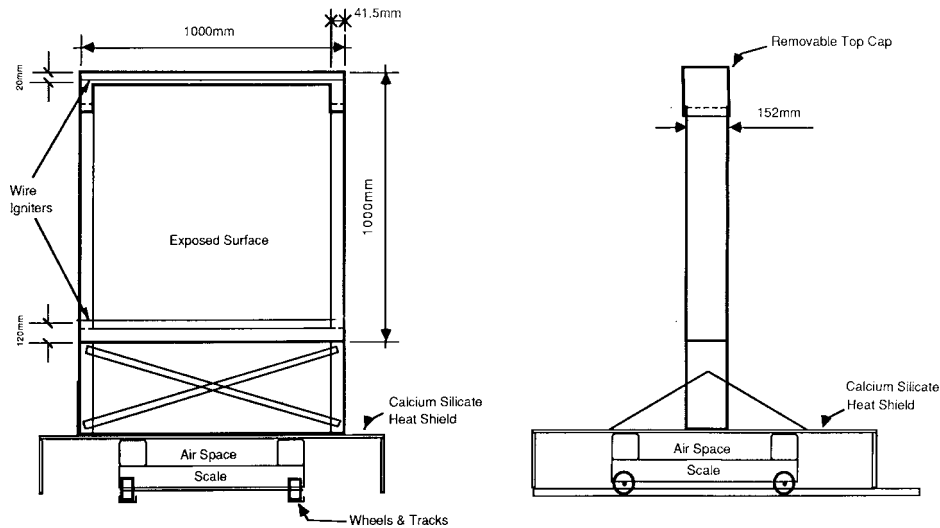

FIG. 2 Sample Holder

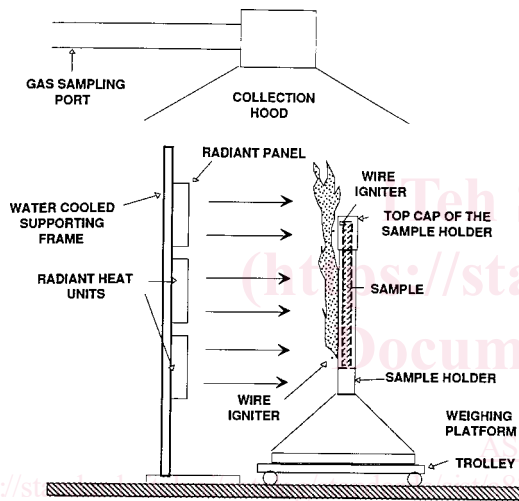

FIG. 3 Intermediate Scale Calorimeter

6.2.7 *Radiant Panel Constant Irradiance Controller*—The irradiance from the radiant panel assembly shall be capable of being held at a preset level by means of regulating the flow of natural gas to the burners (see X1.2 for more information). The flow of the gas is regulated using an automatic flow controller, motorized valve, and a thermocouple located on the surface of a ceramic burner. The irradiance is directly proportional to the temperature on the surface of the ceramic burners. Gas flow shall be continuously measured to calculate the heat released from the radiant panel assembly. This value is needed in computations of the heat release rate from the specimen.

6.3 *Specimen Holder Assembly Components:*

6.3.1 *Specimen Holder*—The specimen holder assembly is shown in Fig. 2 and is capable of holding a specimen up to 152 mm thick. (A thicker specimen holder is necessary to accommodate specimens thicker than 152 mm.) The top portion of the assembly is removable to facilitate specimen insertion. Prior to starting the test the specimen shall be protected from

the radiant panel heat flux exposure by the water cooled shield (see 6.4.1). A drip tray, 300 mm wide by 50 mm deep by 914 mm long, shall be attached to the floor of the specimen holder directly below the specimen frame to contain limited amounts of materials that melt and drip. Two wire igniters described in 6.4.3 are attached to the specimen holder.

6.3.2 *Weighing Platform*—The general arrangement of the specimen holder and the weighing platform is indicated in Fig. 2. The weighing platform⁷ shall be capable of weighing the specimen to an accuracy of one gram. The platform shall be protected from the radiant panel assembly by an insulation board cover as shown in Fig. 2.

6.3.3 *Specimen Holder Trolley*—A trolley, as shown in Fig. 3, shall be provided to hold the specimen holder and weighing platform to permit movement of the specimen to a predetermined location in front of the radiant panel at the beginning of a test. The trolley shall be placed on rails or guides to facilitate exact specimen placement with respect to the radiant panel. The trolley tracks shall be located perpendicular to the plane of the radiant panel so that the specimen is moved directly toward the radiant panel. The trolley tracks shall be long enough to move the specimen holder to a distance of 6 m from the radiant panel. This distance makes mounting the specimen easier and allows testing of parameters other than heat release at very low heat fluxes. Heat flux values of 25 and 50 kW/m² are achieved at distances less than 1 m.

6.4 *Other Major Components:*

6.4.1 *Specimen Shield*—A water cooled shield (see Fig. 4) shall be provided to absorb the thermal energy from the radiant panels prior to testing. The shield is constructed so that a preset water flow will maintain a shield temperature on the unexposed face below 100°C. The shield shall be positioned directly in front of the radiant panel assembly at a distance of 150 mm.

⁷ A Sartorius Model F150S Electromagnetic Scale, has been found suitable for this application.

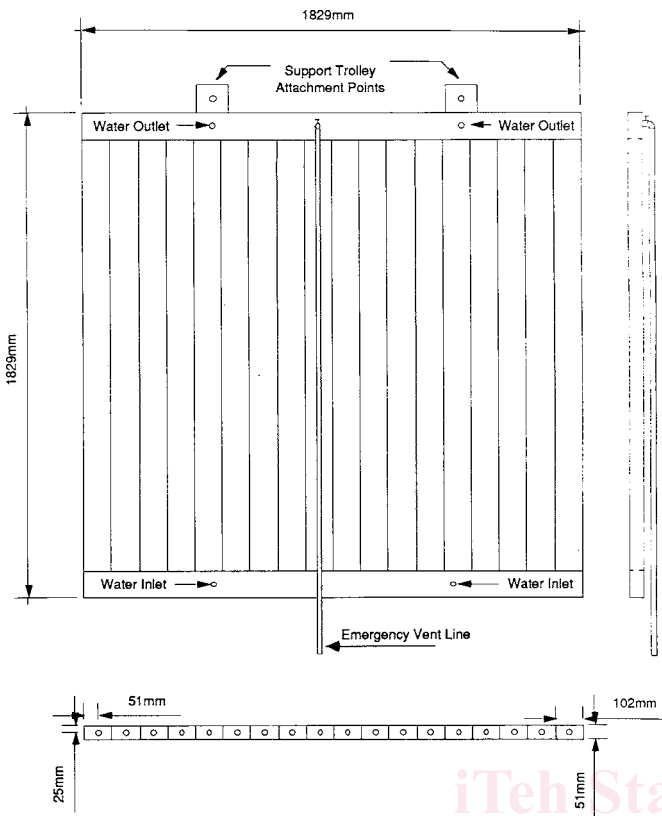

FIG. 4 Radiation Shield

The mounting method used shall accommodate removing the shield in less than 2 s.

6.4.2 *Infrared Pyrometer*—A pyrometer⁸ is used to view the specimen surface through the 25 mm gap between the radiant panels. The pyrometer is positioned 0.3 m to 0.5 m behind the radiant panel assembly at a height equal to the geometrical center of the specimen. The measurement technique including specimen emissivity adjustments is detailed in (4).

6.4.3 *Wire Igniters*—Two 0.81 mm Chromel wires (from Type K thermocouple wires) are used as igniters. One wire is positioned horizontally, spanning the full width of the specimen, 80 mm above the bottom exposed edge of the specimen and 15 mm from the specimen surface. The other wire is positioned horizontally, spanning the full width of the specimen, 20 mm above the top exposed edge of the specimen and 15 mm from the specimen's vertical plane. A spring, protected from the radiant heat, shall be attached to one end of the wires to compensate for the wire expansion during the test. It shall remain under tension throughout the test so that the igniter wire remains in position. When used, sufficient power shall be applied to the wire that will produce an orange glow. Low voltages, up to 30 V, shall be used for safety reasons. More information about the choice of the wire igniters is given in X1.3.

⁸ A suitable optical infrared pyrometer has a temperature range of 0–1000°C and a wavelength band of 8–12 μm. The emissivity measuring range of the pyrometer shall be adjustable. The pyrometer shall have the through-the-lens sighting with a narrow field of view. The maximum target area diameter shall not be more than 30 mm at a range of measuring distances between 500 and 2000 mm. The pyrometer shall have an analog output.

6.4.4 *Heat Flux Meter*—The total heat flux meter shall be of the Gardon⁹ (foil) or Schmidt-Boelter (thermopile) type, with a design range of about 50 kW/m². The target receiving radiation, and possibly to a small extent convection, shall be flat, circular, approximately 12.5 mm in diameter, and coated with a durable matt-black finish. The target shall be water cooled. Radiation shall not pass through any window before reaching the target. The instrument shall be robust, simple to set up and use, and stable in calibration. The instrument shall have an accuracy of within ±3 % and a repeatability of within 0.5 %.

6.4.5 *Heat Flux Calibration Panel*—A panel to establish the heat flux/distance relationship shall be constructed from nominal 12.7 mm thick calcium silicate board of nominal density 740 kg/m³. The panel shall be the same size as a specimen (1000 by 1000 mm) and shall have holes with diameters to accommodate the heat flux meter from 6.4.4. Five rows and columns of holes shall be drilled 224 mm apart and 51 mm from the edges on all sides of the panel.

6.4.6 *Digital Data Collection*—The data collection system shall be equal to or better than that required in Proposal P147. Readings shall be made at intervals not exceeding 2 s.

6.4.7 *Exhaust Collection System*:

6.4.7.1 Construct the exhaust collection system with the following minimal requirements: a blower, steel hood, duct, bidirectional probe, thermocouple(s), oxygen measurement system, smoke obscuration measurement system (white light photocell lamp/detector or laser) and combustion gas sampling and analysis system. Construct the exhaust collection system as shown in Fig. 5 and as explained in Annex A1.

6.4.7.2 Ensure that the system for collecting the smoke (which includes gaseous combustion products) has sufficient exhaust capacity and is designed in such a way that all of the combustion products leaving the burning specimen are collected. Design the capacity of the evacuation system such that it will exhaust minimally all combustion gases leaving the specimen (see A1.1.4).

6.4.7.3 Place probes for sampling of combustion gas and for measurement of flow in accordance with 6.4.8.

6.4.7.4 Make all measurements of smoke obscuration, gas concentrations or flows at a position in the exhaust duct where the exhaust is uniformly mixed so that there is a nearly uniform velocity across the duct section.

6.4.7.5 If the straight section before the measuring system is at least eight times the inside diameter of the duct the exhaust is likely to be uniformly mixed. If a measuring system is positioned at a distance of less than eight diameters, demonstrate the achievement of equivalent results.

6.4.8 *Instrumentation in Exhaust Duct*—The following specifications are minimum requirements for exhaust duct instrumentation. Additional information is found in Annex A2.

6.4.8.1 *Flow*—Measure the flow in the exhaust duct by means of a bidirectional probe, or an equivalent measuring system, with an accuracy of at least ±6 % (see Annex A2 for further details). The response time to a stepwise change of the duct flow shall not exceed 5 s, to reach 90 % of the final value.

⁹ A Medtherm Model R-8015-C-15-072, from Medtherm Corp., Huntsville, AL, has been found suitable for this purpose.

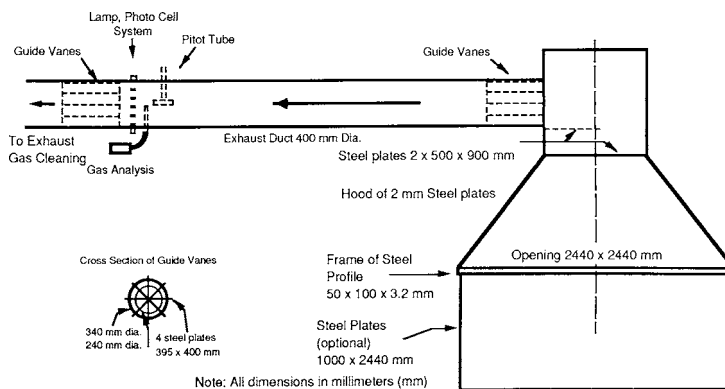

FIG. 5 Collection Hood and Exhaust System

6.4.9 Combustion Gas Analysis:

6.4.9.1 *Sampling Line*—Construct the sampling line tubes of a material not influencing the concentration of the combustion gas species to be analyzed. The following sequence of the gas train has been shown to be acceptable: sampling probe, soot filter, cold trap, gas path pump, vent valve, plastic drying column and carbon dioxide removal columns (if used), flow controller and oxygen analyzer (see Fig. 6 and Annex A2 for further details). Alternative designs of the sampling line must give equivalent results. The gas train shall also include appropriate spanning and zeroing facilities.

6.4.9.2 *Oxygen Measurement*—Measure the oxygen concentration with an accuracy of at least $\pm 0.04\%$ of full scale in the output range of 0 to 25 vol % oxygen, or $\pm 0.01\%$ vol % oxygen, in order to have adequate measurements of rate of heat release. Take the combustion gas sample from the end of the sampling line. Calculate the time delay, including the time constant of the instrument; it is a function of the exhaust duct flow. This time delay shall not exceed 60 s. (See Annex A6 for further details.)

6.4.9.3 *Carbon Monoxide and Carbon Dioxide Measurement*—Measure the combustion gas species with an instrument having an accuracy of at least $\pm 0.1\%$ for the carbon dioxide and $\pm 0.02\%$ for carbon monoxide. A

suitable output range is 0 to 1 vol % for carbon monoxide and 0 to 6 vol % for carbon dioxide. Take the combustion gas sample from the end of the sampling line. Calculate the time delay, including the time constant of the instrument; it is a function of the exhaust duct flow. It shall be a maximum of 60 s. (See Annex A6 for further details.)

6.4.10 *Smoke Obscuration Measurement:*

6.4.10.1 Install an optical system for measurement of light obscuration across the centerline of the exhaust duct. Determine the optical density of the smoke by measuring the light transmitted with a photometer system consisting of a white light source and a photocell/detector or a laser system for measurement of light obscuration across the centerline of the exhaust duct.

6.4.10.2 One photometer system found suitable consists of a lamp, lenses, an aperture, and a photocell. See Fig. 7 and Annex A2 for further details. Construct the system so that soot deposits on the optics during a test do not reduce the light transmission by more than 5 %.

6.4.10.3 Alternatively, instrumentation constructed using a 0.5 to 2.0 mW helium-neon laser, instead of a white light system is also acceptable. See Fig. 8 and A2.4 for further details. It has been shown that white light and laser systems will give similar results (5, 6).

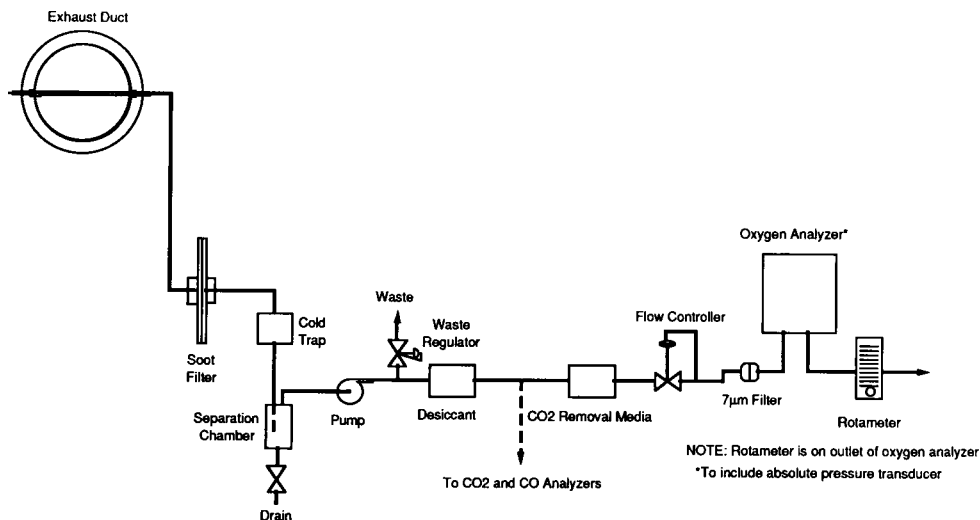

FIG. 6 Schematic of Gas Sampling Train

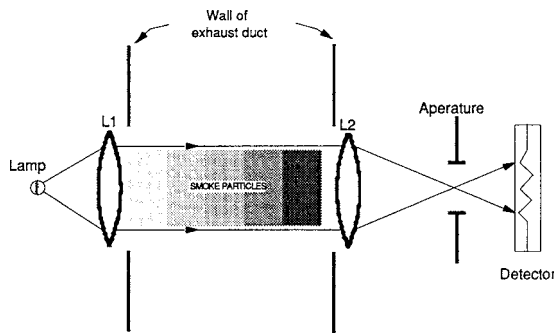

FIG. 7 White Light Optical System

6.4.11 Thermocouples:

6.4.11.1 All thermocouples shall be 0.127 mm (0.005 in. or 5 mils) Type K, Chromel-Alumel.

6.4.11.2 The interior thermocouples shall be inserted in holes that have been predrilled from the unexposed face of the sample toward the face to the desired depth. These thermocouples shall be sheathed with ceramic insulation.¹⁰ The two wires leading up to the junctions of surface thermocouples shall be bared for a distance of at least 50 mm on both sides of the junction. Each lead shall be pulled tight so that the bead is contacting the surface and stapled at a point on each wire 25 mm away from the junction. The bead shall be pushed by thumb with moderate force into the surface if it will penetrate.

7. Hazards

7.1 The test procedures involve high temperatures and combustion processes. Therefore the potential exists for burns, ignition of extraneous objects or clothing, and for inhalation of combustion products. The operator shall use protective gloves and clothes while removing the specimen shield and while moving the specimen trolley toward or away from the radiant panels. The construction of a viewing wall with windows is recommended for laboratories with small spaces where the operator and viewers cannot move far enough away from the area of the radiant panel.

7.2 The water cooled shield placed in front of the radiant panel assembly dramatically lowers the heating of the laboratory space. Additionally, it lowers the potential for harm to operators working in the area.

8. Test Specimens

8.1 Size and Preparation:

8.1.1 Test specimen's dimensions shall be 1000 by 1000 mm and up to 152 mm in thickness¹¹. They shall be representative of the construction of the end-use product. Test materials and assemblies of normal thickness, 152 mm or less, using their full thickness.

8.1.2 If a product is designed to normally have joints in a field application, then that specimen shall incorporate the joint detail. Center the joint in the specimen's vertical or horizontal

¹⁰ 0.4 mm (1/64 in.) bore diameter insulators from Omega Engineering, One Omega Drive, Stamford, CT has been found suitable for this.

¹¹ If specimens of thickness greater than 152 mm are to be tested, a specimen holder shall be constructed to accommodate the desired specimen thickness.

centerline as appropriate. Also test the specimen without a joint detail if the design does not include a joint.

8.1.3 Cover the edges of the specimen with 12 mm ceramic wool blanket to eliminate the gap between the holder and the specimen.

8.2 Conditioning—Condition specimens to moisture equilibrium (constant weight) at an ambient temperature of 23 ± 3°C and a relative humidity of 50 ± 5 %. Constant weight is achieved when two weighings differ by no more than 0.2 % in 24 h.

9. Calibration

9.1 Calibrate all instruments carefully with standard sources after initial installation. Among the instruments to be calibrated are load cells or weighing platforms, smoke meters, flow or velocity transducers, infrared pyrometer and gas analyzers.

9.2 Heat Flux/Distance Relationship:

9.2.1 Ignite the radiant panel and allow it to come to equilibrium as indicated by its constant heat release rate.

9.2.2 Generate a curve of average flux measurements over the specimen surface versus specimen distance from the radiant panels. Place the calibration panel in the same position as a specimen and insert the flux meter from the unexposed face through the holes. The target face of the flux meter shall extend 15 mm toward the radiant panel from the exposed surface of the calibration panel to minimize the convective heat transfer contribution. After the calibration panel has come to equilibrium, make the flux measurements with the target face of the flux meter at the following distance away from the radiant panel: 300, 400, 600, 800, 1000, and 2000 mm. If lower heat fluxes than the one corresponding to a 2 m distance are used, continue calibrating until past the needed distance.

9.2.3 No individual flux measurement shall deviate from the average at each of the distances by more than ± 6 %. The average heat flux measurements in the bottom row of the calibration panel shall not deviate from that in any of the heat flux values used by more than ± 5 %.

9.2.4 Use the curve generated in 9.2.2 to determine the distance from the radiant panel for a desired radiant heat flux exposure.

9.2.5 Perform calibration every three months or more frequently if any significant changes to equipment are made or if calibration is suspect.

9.3 Heat Release:

9.3.1 Perform the calibration of the heat release instrumentation in the exhaust duct by burning propane or methane gas and comparing the heat release rates calculated from the metered gas input, and those calculated from the measured oxygen consumption. The value of net heat of combustion for methane is 50.0 MJ/kg and that for propane is 46.5 MJ/kg. Position the calibration burner in the same location where the specimen is to be placed during a 35 kW/m² exposure test. Measure the gas flow at a pressure of 101 ± 5 kPa (standard atmospheric pressure, measured at the flow gage) and a temperature of 20 ± 5°C.

9.3.2 A suitable calibration burner is a sand diffusion burner with a 0.3 by 0.3 m top surface and a 0.15 m depth. Construct such a gas burner with a 25 mm thick plenum. Alternatively, use a minimum 100 mm layer of Ottawa sand to provide the

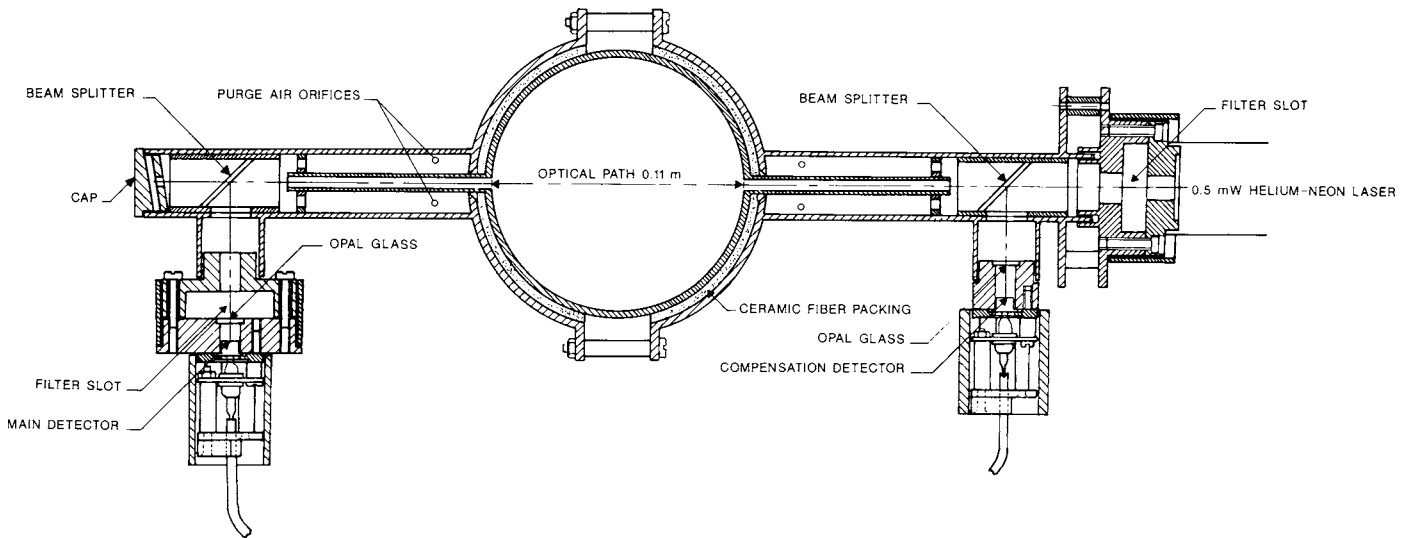

FIG. 8 Smoke Obscuration Measuring System

horizontal surface through which the gas is supplied. This type of burner is shown in Fig. 9. The gas supply to the burner shall be technical grade propane or methane. Do not premix the gas for the burner flame with air. Meter the flow of gas and keep it constant throughout the calibration test.

9.3.3 Another suitable calibration burner is a pipe, with an inner diameter of 100 ± 1.5 mm, supplied with gas from beneath (see ISO 9705). Do not premix the gas for the burner flame with air.

9.3.4 Obtain a minimum of two calibration points. Obtain a lower heat release rate value of 100 kW and a higher heat

release rate of 300 kW, from the gas burner alone. Take measurements at least once every 6 seconds and start 1 minute prior to ignition of the burner. Determine the average heat release rate over a period of at least one minute by (a) the oxygen consumption method and (b) calculating the heat release rate from the gas mass flow and the net heat of combustion. A correct factor of heat released per oxygen consumed for the calibration gas ($E_{\text{propane}} = 12.78$ MJ/kg O₂, $E_{\text{methane}} = 12.51$ MJ/kg O₂) must be used in the oxygen consumption method. The difference between the two values shall not exceed 5%. This comparison shall be made only after steady state conditions have been reached.

9.3.5 Take measurements at least once every 6 s and start 1 min prior to ignition of the burner. Determine the average rate of heat release over a period of at least 1 min by the oxygen consumption method and calculating the heat release rate from the gas mass flow and the net heat of combustion. The difference between the two values shall not exceed 5%. Make this comparison only after steady state conditions have been reached.

9.3.6 Perform calibration every three months or more frequently if any significant changes to equipment are made or if calibration is suspect.

9.3.7 When calibrating a new system, or when modifications are introduced, check the response time of the measuring system by the following test sequence:

Time, min	Burner Output, kW
0 to 5	0
5 to 10	40
10 to 15	160
15 to 20	0

The response of the system to a stepwise change of the heat output from the burner shall be a maximum of 12 s to 90 % of final value.

9.3.8 Perform the calibration in 9.3.7 at a duct air flow of 2 m³/s.

9.3.9 The change in measured rate of heat release, comparing time average values over 1 min, shall not be more than 10 % of the actual heat output from the burner.

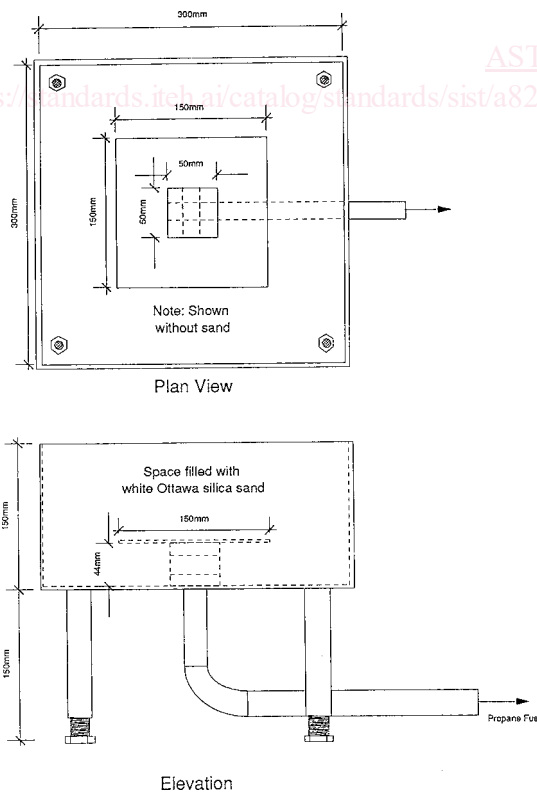

FIG. 9 Sand Burner

9.4 *Mass Loss*—If required by the type of scale used, perform the calibration by loading the weighing platform with known masses corresponding to the measuring range of interest, to ensure that the requirements of accuracy in 6.3.2 are fulfilled. Carry out this calibration daily, prior to testing.

9.5 *Smoke Obscuration*—Calibrate the smoke meter initially to read correctly for two neutral density filters of significantly different values, and also at 100 % transmission. The use of neutral density filters at 0.5 and 1.0 values of optical density has been shown to be satisfactory for this calibration. Once this calibration is set, only the zero value of extinction coefficient (100 % transmission) needs to be verified each day, prior to testing. Investigate any excessive departure from the zero line at the end of a test, and correct it.

9.6 *Gas Analysis*—Calibrate gas analyzers daily, prior to testing (see Guide E800 for further guidance).

9.7 *Heat Flux Meter*—Check the calibration of the heat flux meter whenever a recalibration of the apparatus is carried out by comparison with an instrument (of the same type as the working heat flux meter and of similar range) held as a reference standard and not used for any other purpose. Fully calibrate the reference standard at a standardizing laboratory at yearly intervals.

10. Procedure

10.1 Preparation:

10.1.1 Open the water valve to the steel tubing that support the radiant panel and adjust the water flow sufficiently high that water exiting the frame will not exceed 100°C in temperature.

10.1.2 Position the specimen holder assembly remote to the desired test location.

10.1.3 Place the water cooled shield in front of the radiant panel assembly and adjust the water flow sufficiently high that water exiting the shield will not exceed 100°C in temperature.

10.1.4 Establish a duct air flow previously determined to correspond to oxygen concentration between 20.2 and 20.4% with the radiant panel in operation only.

NOTE 1—Such a duct flow will be close to 1.6 m³/s, but that is not necessarily the case.

10.1.5 Turn on the flow of gas to each of the radiant panels and ignite them.

10.1.6 Allow the burners to operate for 30 minutes prior to testing.

10.1.7 Adjust, if necessary, the water flows and the duct flow to the required values.

10.1.8 Turn on all sampling and recording devices and calibrate the analyzers.

10.1.9 Insert the specimen into the specimen holder. Place the specimen in the specimen holder by removing the top specimen holder cap section, inserting the specimen and replacing the top cap.

10.1.10 Switch on the wire igniters.

10.1.11 If heat flow through the specimen is to be monitored, attach the thermocouples as described in 6.4.2 and 6.4.3.

10.2 Procedure:

10.2.1 Move the specimen trolley to the location necessary for the desired flux exposure.

10.2.2 Obtain sufficient data, at least 30 s, to ensure the signal from the weighing platform settles down to equilibrium and an adequate baseline has been reached.

10.2.3 Remove the water cooled specimen shield in not more than 2 s and start the timer marking the beginning of the test.

10.2.4 Record the times when flashing or transitory flaming occur. When sustained flaming occurs, record the time and turn off the igniters. If the flame extinguishes after turning off the igniters, turn on the igniters again within 5 seconds and do not turn the igniters off until the entire test is completed. Report these events in the test report.

10.2.5 If the duct flow is not sufficient to collect all the fire gases, then increase the duct flow to a sufficient value.

10.2.6 Record all important events during the test like cracking, melting, collapse of all or part of the specimen, deformations, and intumescenting.

10.2.7 Collect data until 2 min after sustained flaming occurs on the unexposed side of the specimen or a predetermined time period.

10.2.8 Withdraw the specimen trolley from exposure to radiant heat and insert the specimen radiation shield.

10.2.9 Unless otherwise specified in the material or performance standard, make three determinations and report as specified in Section 12.

11. Calculation

11.1 The specimen heat release rate is calculated by subtracting the radiant panel assembly heat release rate (which is the theoretical baseline) from the total heat release rate. The radiant panel heat release rate contribution measured as the product of the gas flow rate and the net heat of combustion of the gas (see 9.3.1), shall be multiplied by a factor, to take into account the correct ratio of heat released per oxygen consumed for natural gas (1.047) or propane (1.025). The testing laboratory shall choose one of the equations in A4.1 to calculate heat release, based on the gas analyzers installed. Report the equations used for heat release rate calculations, and state whether carbon monoxide and/or carbon dioxide measurements were used for this. Considerations for heat release measurements are presented in Annex A3. Calculate heat release data, using the equations presented in A4.1 and A4.2.¹²

11.2 Calculate mass loss rate and effective heat of combustion using the procedures in Annex A5.

11.3 Calculate smoke release data using the equations in A4.3.

11.4 Calculate gas yield data using the equations in A4.4.

11.5 Calculate the specimen carbon monoxide and carbon dioxide concentrations by subtracting the radiant panel contributions (baseline data) from the total values.

11.6 The normal exposed surface area of the specimen is 0.84 m². Determine the exposed surface area for the apparatus

¹² The correction factors are based on the ratio between the rate of heat released per unit oxygen consumed for most fuels (which is $E = 13.1$ MJ/kg) and those for natural gas (which is $E_{\text{methane}} = 12.51$ MJ/kg) and for propane (which is $E_{\text{propane}} = 12.78$ MJ/kg).

in which the tests are conducted, and use that value to calculate parameters per unit surface area. Report the exposed surface area.

11.7 When parameters are to be reported per unit surface area, the absolute values determined shall be divided by the exposed surface area of the apparatus before reporting. Use the correct exposed surface area to calculate parameters per unit surface area.

12. Report

12.1 Report the following information:

12.2 *Descriptive Information:*

12.2.1 Name and address of the testing laboratory,

12.2.2 Specimen identification code or number,

12.2.3 Date and identification number of the report,

12.2.4 Name and address of the test sponsor,

12.2.5 Name of product manufacturer or supplier, if known,

12.2.6 Composition or generic identification,

12.2.7 Density, or mass per unit surface area, total mass, thickness of the main components in the specimen, thickness of the specimen, moisture content of hygroscopic materials and mass of combustible portion of specimen, if known,

12.2.8 Description of the specimen, if different from the product,

12.2.9 Details of specimen preparation by the testing laboratory,

12.2.10 Details of special mounting methods used,

12.2.11 Heating flux and exhaust system flow,

12.2.12 Number of replicates tested under the same conditions. (This shall be a minimum of three except for exploratory testing),

12.2.13 Conditioning of the specimens,

12.2.14 Date of test, and

12.2.15 Test number and any special remarks.

12.3 *Test Results:* (See Also Appendix):

12.3.1 Table of numerical results containing:

12.3.1.1 Time to sustained flaming(s) on the exposed and unexposed sides (s),

12.3.1.2 Peak rate of heat release (in kW and kW/m²), and the time at which it occurred (s),

12.3.1.3 Average rate of heat release values for the first 60, 180, 300 s after ignition, or for other appropriate periods (kW),

12.3.1.4 Total heat released (in MJ and MJ/m²),

12.3.1.5 Peak rate of smoke release (m²/s), and the time at which it occurred,

12.3.1.6 Average rate of smoke release values for the first 60, 180, 300 s after ignition, or for other appropriate periods (m²/s),

12.3.1.7 Total smoke released (m²),

12.3.1.8 Total mass loss (kg),

12.3.1.9 Total percentage of mass loss (%),

12.3.1.10 Average effective heat of combustion for the entire test (MJ/kg),

12.3.1.11 Peak yield of carbon monoxide (kg of CO/kg of fuel),

12.3.1.12 Equation used to calculate rate of heat release,

12.3.1.13 Peak optical density of smoke (optional),

12.3.1.14 Total percentage of combustible mass loss (%) (optional),

12.3.1.15 Average yield of carbon monoxide (kg CO/kg fuel) (optional),

12.3.1.16 Average yield of carbon dioxide (kg CO₂/kg fuel) (optional),

12.3.1.17 Carbon monoxide/carbon dioxide yield ratio (kg of CO/kg of CO₂) (optional),

12.3.1.18 Average yield of any other measured combustion gas (kg combustion gas/kg fuel) (optional),

12.3.1.19 Material emissivity, and.

12.3.1.20 Exposed surface area.

12.3.2 *Graphical Results:*

12.3.2.1 Plot of rate of heat release versus time,

12.3.2.2 Plot of rate of smoke release versus time,

12.3.2.3 Plot of optical density versus time,

12.3.2.4 Plot of mass loss versus time,

12.3.2.5 Plot of mass loss rate versus time,

12.3.2.6 Plot of effective heat of combustion versus time,

12.3.2.7 Plots of all temperatures (including duct) versus time,

12.3.2.8 Plot of concentration of carbon monoxide versus time,

12.3.2.9 Plot of concentration of carbon dioxide versus time,

12.3.2.10 Plots of concentration of any other measured combustion gas versus time,

12.3.2.11 Plot of mass flow in the exhaust duct versus time,

12.3.2.12 Plot the rate of heat release versus time from the radiant panel, and

12.3.2.13 Report of smoke obscuration, carbon monoxide, and temperature measurements in the room in the same fashion, if they have been made.

12.3.3 *Descriptive Results:*

12.3.3.1 Photographs or videotape of the fire development, and

12.3.3.2 All available information requested in 12.2, including information on physical changes to the specimen during the test (see 5.5).

13. Precision and Bias¹³

13.1 Information on reproducibility is presented in 13.2-13.4. Information on repeatability obtained from an early study in a single laboratory (9) also is available.

13.2 An interlaboratory study was performed, using the three laboratories available in the United States, in which test materials were chosen intended to challenge the capabilities of the instrument. The test materials provided a broad range of fire-test-response characteristics and offered the expected testing difficulties. Details of the experimental work and of the results can be found in Ref (10). The three laboratories tested six samples in triplicate, and one laboratory each tested the seventh and eighth sample in triplicate. The materials selected are described in 13.2.1-13.2.8

13.2.1 *Oriented Strand Board*, 11 mm thick, tested at a heat flux of 25 kW/m²(OSB 25).

13.2.2 *Oriented Strand Board*, 11 mm thick, tested at a heat flux of 50 kW/m²(OSB 50).

¹³ A research report is available from ASTM International Headquarters. Request RR:E05-1009.