



# Standard Test Method for Surface Burning Characteristics of Building Materials<sup>1</sup>

This standard is issued under the fixed designation E84; the number immediately following the designation indicates the year of original adoption or, in the case of revision, the year of last revision. A number in parentheses indicates the year of last reappraisal. A superscript epsilon ( $\epsilon$ ) indicates an editorial change since the last revision or reappraisal.

*This standard has been approved for use by agencies of the Department of Defense.*

## 1. Scope

1.1 This fire-test-response standard for the comparative surface burning behavior of building materials is applicable to exposed surfaces such as walls and ceilings. The test is conducted with the specimen in the ceiling position with the surface to be evaluated exposed face down to the ignition source. The material, product, or assembly shall be capable of being mounted in the test position during the test. Thus, the specimen shall either be self-supporting by its own structural quality, held in place by added supports along the test surface, or secured from the back side.

1.2 The purpose of this test method is to determine the relative burning behavior of the material by observing the flame spread along the specimen. Flame spread and smoke developed index are reported. However, there is not necessarily a relationship between these two measurements.

1.3 The use of supporting materials on the underside of the test specimen has the ability to lower the flame spread index from those which might be obtained if the specimen could be tested without such support. These test results do not necessarily relate to indices obtained by testing materials without such support.

1.4 Testing of materials that melt, drip, or delaminate to such a degree that the continuity of the flame front is destroyed, results in low flame spread indices that do not relate directly to indices obtained by testing materials that remain in place.

1.5 ~~The values stated in inch-pound units are to be regarded as standard. The values given in parentheses are mathematical conversions to SI units that are provided for information only and are not considered standard.~~ The values stated in inch-pound units are to be regarded as standard. The values given in parentheses are mathematical conversions to SI units that are provided for information only and are not considered standard.

1.6 The text of this standard references notes and footnotes that provide explanatory information. These notes and footnotes, excluding those in tables and figures, shall not be considered as requirements of the standard.

1.7 *This standard is used to measure and describe the response of materials, products, or assemblies to heat and flame under controlled conditions, but does not by itself incorporate all factors required for fire-hazard or fire-risk assessment of the materials, products, or assemblies under actual fire conditions.*

1.8 *This standard does not purport to address all of the safety concerns, if any, associated with its use. It is the responsibility of the user of this standard to establish appropriate safety and health practices and determine the applicability of regulatory limitations prior to use.*

## 2. Referenced Documents

### 2.1 ASTM Standards:<sup>2</sup>

A390 Specification for Zinc-Coated (Galvanized) Steel Poultry Fence Fabric (Hexagonal and Straight Line)

C1186 Specification for Flat Fiber-Cement Sheets

D4442 Test Methods for Direct Moisture Content Measurement of Wood and Wood-Base Materials

D4444 Test Method for Laboratory Standardization and Calibration of Hand-Held Moisture Meters

E69 Test Method for Combustible Properties of Treated Wood by the Fire-Tube Apparatus

E136 Test Method for Behavior of Materials in a Vertical Tube Furnace at 750C

E160 Test Method for Combustible Properties of Treated Wood by the Crib Test<sup>3</sup>

E162 Test Method for Surface Flammability of Materials Using a Radiant Heat Energy Source

E176 Terminology of Fire Standards

E286 Method of Test for Surface Flammability of Building Materials Using an 8-ft (2.44-m) Tunnel Furnace<sup>0</sup>

<sup>1</sup> This test method is under the jurisdiction of ASTM Committee E05 on Fire Standards and is the direct responsibility of Subcommittee E05.22 on Surface Burning. Current edition approved Aug. 1, 2009; 2010. Published September 2009; February 2010. Originally approved in 1950. Last previous edition approved in 2009 as E84 - 09bc. DOI: 10.1520/E0084-09C; 10.1520/E0084-10.

<sup>2</sup> For referenced ASTM standards, visit the ASTM website, www.astm.org, or contact ASTM Customer Service at service@astm.org. For Annual Book of ASTM Standards volume information, refer to the standard's Document Summary page on the ASTM website.

- E2231 Practice for Specimen Preparation and Mounting of Pipe and Duct Insulation Materials to Assess Surface Burning Characteristics
- E2404 Practice for Specimen Preparation and Mounting of Textile, Paper or Polymeric (Including Vinyl) Wall or Ceiling Coverings to Assess Surface Burning Characteristics
- E2573 Practice for Specimen Preparation and Mounting of Site-Fabricated Stretch Systems to Assess Surface Burning Characteristics
- E2579 Practice for Specimen Preparation and Mounting of Wood Products to Assess Surface Burning Characteristics
- E2599 Practice for Specimen Preparation and Mounting of Reflective Insulation Materials and Radiant Barrier Materials for Building Applications to Assess Surface Burning Characteristics
- 2.2 *NFPA Standards:*<sup>3</sup>
- NFPA 262 Standard Method of Test for Flame Travel and Smoke of Wires and Cables for Use in Air-Handling Spaces (2007)
- 2.3 *UL Standards*<sup>4</sup>
- UL 1820 Standard for Safety for Fire Test of Pneumatic Tubing for Flame and Smoke Characteristics (2004)
- UL 1887 Standard for Fire Test of Plastic Sprinkler Pipe for Visible Flame and Smoke Characteristics (2004)
- UL 2024 Standard for Safety for Optical Fiber and Communication Cable Raceway (2004)

### 3. Terminology

3.1 *Definitions*—For definitions of terms used in this test method refer to Terminology E176. The term flame spread index from Terminology E176 is of particular interest to this standard and is defined in 3.1.1.

3.1.1 *flame spread index, n*—a number or classification indicating a comparative measure derived from observations made during the progress of the boundary of a zone of flame under defined test conditions.

3.2 *Definitions of Terms Specific to This Standard:*

3.2.1 *smoke developed index, n*—a number or classification indicating a comparative measure derived from smoke obscuration data collected during the test for surface burning characteristics.

3.2.2 *surface flame spread, n*—the propagation of a flame away from the source of ignition across the surface of the specimen.

### 4. Significance and Use

4.1 This test method is intended to provide only comparative measurements of surface flame spread and smoke density measurements with that of select grade red oak and fiber-cement board surfaces under the specific fire exposure conditions described herein.

4.2 This test method exposes a nominal 24-ft (7.32-m) long by 20-in. (508-mm) wide specimen to a controlled air flow and flaming fire exposure adjusted to spread the flame along the entire length of the select grade red oak specimen in 5½ min.

4.3 This test method does not provide for the following:

4.3.1 Measurement of heat transmission through the tested surface.

4.3.2 The effect of aggravated flame spread behavior of an assembly resulting from the proximity of combustible walls and ceilings.

4.3.3 Classifying or defining a material as noncombustible, by means of a flame spread index by itself.

### 5. Apparatus

5.1 *Fire Test Chamber*—See Figs. 1-5.

5.1.1 The fire test chamber is a rectangular horizontal duct with a removable lid. The inside dimensions are as follows:

|         |   |
|---------|---|
| Width:  | 17 ¾ ± ¼ in. (451 ± 6.3 mm) measured between the top ledges along the side walls, and 17 ⅝ ± ⅜ in. (448 ± 10 mm) at all other points.   |
| Depth:  | 12 ± ½ in. (305 ± 13 mm) measured from the bottom of the test chamber to the top of the ledges on which the specimen is supported. This measurement includes the ⅛ in. (3.2 mm) thickness of the 1 ½ in. (38 mm) wide woven fiberglass gasket tape. |
| Length: | 25 ft ± 3 in. (7.62 m ± 76 mm).   |

5.1.2 The sides and base of the chamber shall be lined with an insulating firebrick with the dimensions of 4 ½ in. by 9 in. by 2 ½ in. thick as illustrated in Fig. 2. The insulating firebrick shall have the following properties:

<sup>3</sup> Available from National Fire Protection Association, 1 Battery March Park, Quincy, MA 02169.

<sup>4</sup> Available from Underwriters Laboratories, 333 Pfingsten Road, Northbrook, IL 60062.

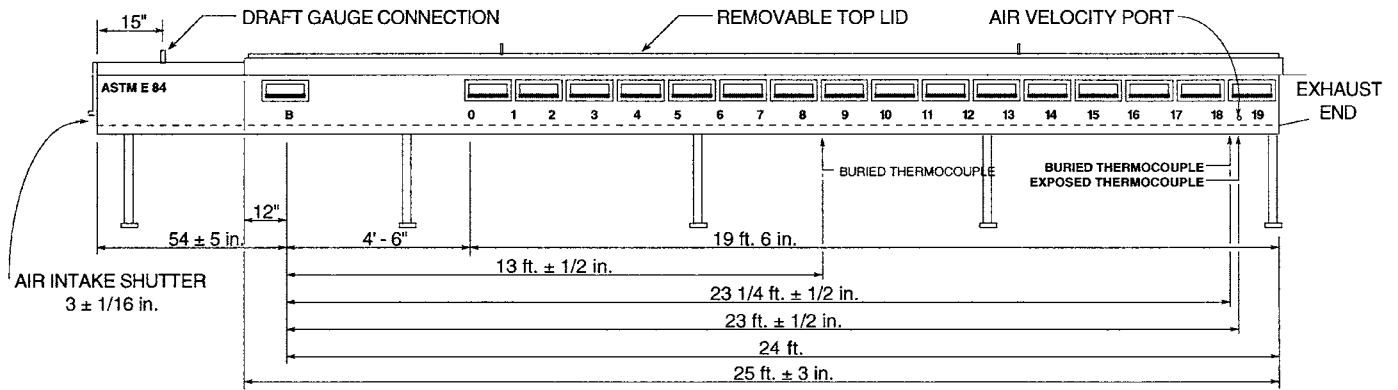

| Inch-Pound Units     | SI Units         |
|----------------------|------------------|
| 3 ± 1/16 in.         | 76.2 ± 1.6 mm    |
| 12 in.               | 304.8 mm         |
| 15 in.               | 381 mm           |
| 54 ± 5 in.           | 1.37 m ± 127 mm  |
| 4 ft. 6 in.          | 1.37 m           |
| 19 ft. 6 in.         | 5.94 m           |
| 13 ft. ± 1/2 in.     | 3.96 m ± 12.7 mm |
| 23 1/4 ft. ± 1/2 in. | 7.1 m ± 12.7 mm  |
| 23 ft. ± 1/2 in.     | 7.0 m ± 12.7 mm  |
| 24 ft.               | 7.32 m           |
| 25 ft. ± 3 in.       | 7.62 m ± 76.2 mm |

FIG. 1 Test Furnace, Showing Some Critical Dimensions (Not a Construction Drawing)

|   |                               |                                   |
|---|-------------------------------|-----------------------------------|
| Maximum Recommended Temperature             | 2600°F (1427°C)               |                                   |
| Bulk Density                                | 48 ± 3 lb/ft <sup>3</sup>     | (0.77 ± 0.046 g/cm <sup>3</sup> ) |
| Thermal Conductivity at Mean Temperature of | Btu·in./h·ft <sup>2</sup> ·°F | W/m·°C                            |
| 500°F (260°C)                               | 1.6                           | 0.23                              |
| 1000°F (538°C)                              | 1.9                           | 0.27                              |
| 1500°F (815°C)                              | 2.2                           | 0.32                              |
| 2000°F (1093°C)                             | 2.6                           | 0.37                              |

5.1.3 One side of the chamber shall be provided with double observation windows<sup>5</sup> with the inside pane flush mounted (see Fig. 2). Exposed inside glass shall be 2 3/4 ± 3/8 by 11 + 1, -2 in. (70 ± 10 by 279 + 25 - 50 mm). The centerline of the exposed area of the inside glass shall be in the upper half of the furnace wall, with the upper edge not less than 2.5 in. (63 mm) below the furnace ledge. The window shall be located such that not less than 12 in. (305 mm) of the specimen width can be observed. Multiple windows shall be located along the tunnel so that the entire length of the test sample is observable from outside the fire chamber. The windows shall be pressure tight in accordance with 7.2 and 7.2.1.

5.1.4 The ledges shall be fabricated of structural materials<sup>6</sup> capable of withstanding the abuse of continuous testing. The ledges shall be level with respect to the length and width of the chamber and each other. The ledges shall be maintained in a state of repair commensurate with the frequency, volume, and severity of testing occurring at any time.

5.1.5 Lid:

5.1.5.1 The lid shall consist of a removable noncombustible metal and mineral composite structure as shown in Fig. 2 and of a size necessary to cover completely the fire test chamber and the test samples. The lid shall be maintained in an unwarped and flat condition. When in place, the lid shall be completely sealed to prevent air leakage into the fire test chamber during the test.

5.1.5.2 The lid shall be insulated with a minimal thickness of 2 in. (51 mm) castable insulation or mineral composite material having physical characteristics comparable to the following:

|   |   |
|---|---|
| Maximum effective use temperature of at least:      | 1200°F (650°C)  |
| Bulk density  | 21 lb/ft <sup>3</sup> (336 kg/m <sup>3</sup> )                    |
| Thermal conductivity at 300 to 700°F (149 to 371°C) | 0.50 to 0.71 Btu·in./h·ft <sup>2</sup> ·°F (0.072 to 0.102 W/m·K) |

5.1.5.3 The entire lid assembly shall be protected with flat sections of nominal 1/4-in. (6.3-mm) fiber-cement board meeting the properties of Annex A3. This protective board shall be maintained in sound condition through continued replacement. The protective board is to be secured to the furnace lid or place on the back side of the test specimen.

<sup>5</sup> Heat-resistant glass, high-silica, 100 % silica glass, nominal 1/4-in. thick has been found suitable for the interior pane. Borosilicate glass, nominal 1/4-in. thick has been found suitable for the exterior pane.

<sup>6</sup> High-temperature furnace refractory. Zirconium silicate, or water-cooled steel tubing have been found suitable for this purpose.

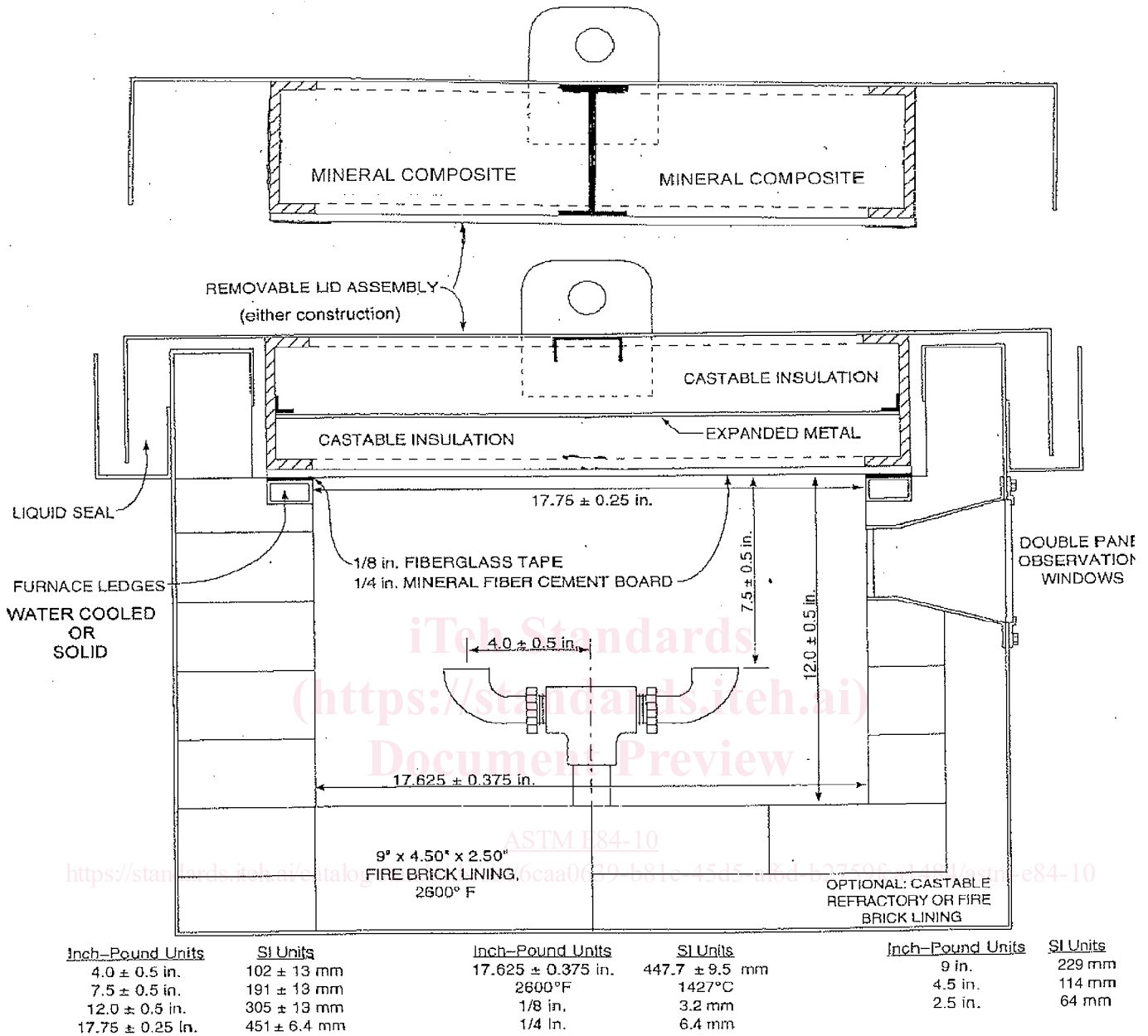

FIG. 2 Test Furnace Showing Critical Dimensions (Not a Construction Drawing)

5.1.6 Gas Burners:

5.1.6.1 One end of the test chamber shall be designated as the “fire end”. This fire end shall be provided with two gas burners delivering flames upward against the surface of the test sample (see Fig. 2). The burners shall be spaced 12 in. (305 mm) from the fire end of the test chamber, and 7 ½ ± ½ in. (190 ± 13 mm) below the under surface of the test sample. Gas to the burners shall be provided through a single inlet pipe, distributed to each port burner through a tee-section. The outlet shall be a ¾ in. NPT elbow. The plane of the port shall be parallel to the furnace floor, such that the gas is directed upward toward the specimen. Each port shall be positioned with its centerline 4 ± ½ in. (102 ± 13 mm) on each side of the centerline of the furnace so that the flame is distributed evenly over the width of the exposed specimen surface (see Fig. 2).

5.1.6.2 The controls used to assure constant flow of gas to the burners during period of use shall consist of a pressure regulator, a gas meter constructed to read in increments of not more than 0.1 ft<sup>3</sup> (2.8 L), a manometer to indicate gas pressure in inches of water, a quick-acting gas shut-off valve, and a gas metering valve.

5.1.7 Air Intake:

5.1.7.1 An air intake shutter shall be located 54 ± 5 in. (1372 ± 127 mm) upstream of the burner, as measured from the burner centerline to the outside surface of the shutter (see Fig. 1). The air intake is to be fitted with a vertically sliding shutter extending the entire width of the test chamber. The shutter shall be positioned so as to provide an air inlet port 3 ± 1/16 in. (76 ± 2 mm) high

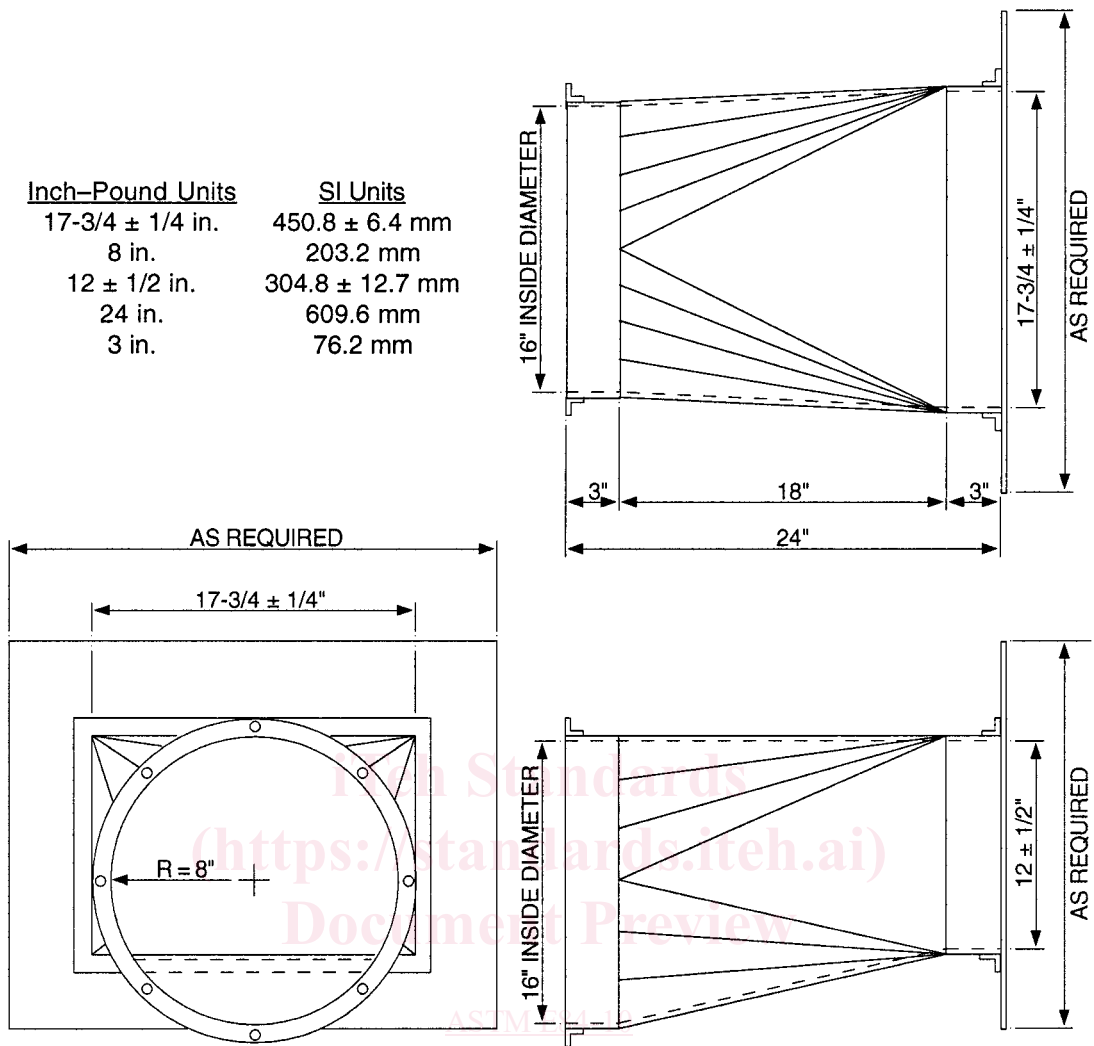

FIG. 3 Typical Exhaust End Transition (Not a Construction Drawing)

measured from the floor level of the test chamber at the air intake point.

5.1.7.2 To provide air turbulence for proper combustion, turbulence baffling shall be provided by positioning six refractory firebricks (as defined in 5.1.2) along the side walls of the chamber. With the long dimension vertical, 4 1/2 in. (114-mm) dimension along the wall, place the bricks as follows from the centerline of the burner ports:

- On the window side at 7, 12, and 20 ± 1/2 ft (2.1, 3.7, and 6.1 ± 0.2 m)
- On the opposite side at 4 1/2, 9 1/2, and 16 ± 1/2 ft (1.3, 2.9, and 4.9 ± 0.2 m)

5.1.7.3 The movement of air shall be by an induced draft system having a total draft capacity of at least 0.15 in. (3.8 mm) water column with the sample in place, the shutter at the fire end open the normal 3 ± 1/16 in. (76 ± 2 mm), and the damper in the wide open position. A draft gage tap to indicate static pressure shall be inserted through the top at the midwidth of the tunnel, 1 ± 0.5 in. (25 ± 12 mm) below the ceiling, 15 ± 0.5 in. (381 ± 12 mm) downstream from the inlet shutter (see Fig. 1).

5.1.8 Exhaust End:

5.1.8.1 The other end of the test chamber is designated as the exhaust end. The exhaust end shall be fitted with a gradual rectangular-to-round transition piece, not less than 20 in. (508 mm) in length, with a cross-sectional area of not less than 200 in.<sup>2</sup> (1290 cm<sup>2</sup>) at any point (see Fig. 3).

5.1.8.2 The transition piece shall in turn be fitted to a 16 in. (406 mm) diameter duct pipe. A typical duct system shown in Fig. 4 contains two 90° elbows (see Fig. 5) with the exhaust duct running beside the fire test chamber. In order to comply with this typical design, the vertical centerline of the exhaust duct system is identical to that of the fire test chamber.

5.1.8.3 The exhaust duct is to be insulated with at least 2 in. (51 mm) of high temperature mineral composition material from the exhaust end of the fire chamber to the photometer location.

5.1.8.4 An exhaust fan shall be installed at the end of the exhaust duct. The air flow shall be controlled as specified in 5.1.11.

5.1.8.5 An alternative exhaust duct layout design shall demonstrate equivalency by meeting the requirements specified in Section 7.

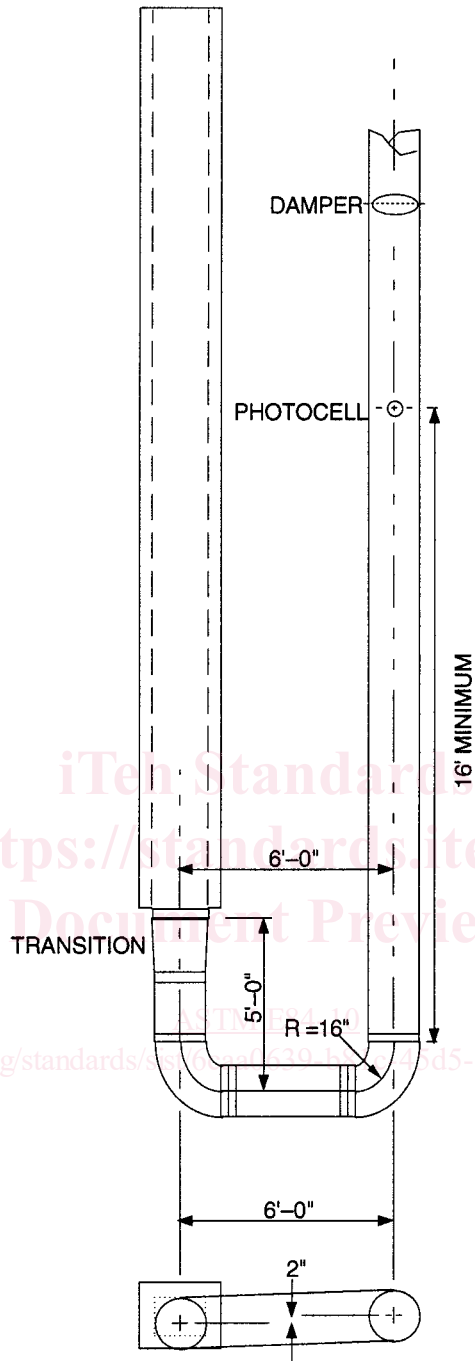

<https://standards.iteh.ai/catalog/standards/si/6ca2/639-b511-45d5-af6d-b2759fca1484/astm-e84-10>

| INCH-POUND UNITS | SI UNITS      |
|------------------|---------------|
| 16 in.           | 406.4 mm      |
| 2 in.            | 50.8 mm       |
| 5 ft.            | 1.52 m        |
| 6 ft.            | 1.83 m        |
| 16 - 40 ft.      | 4.88 - 12.2 m |

FIG. 4 Plan View—Typical Duct System (Not a Construction Drawing)

5.1.9 Photometer System:



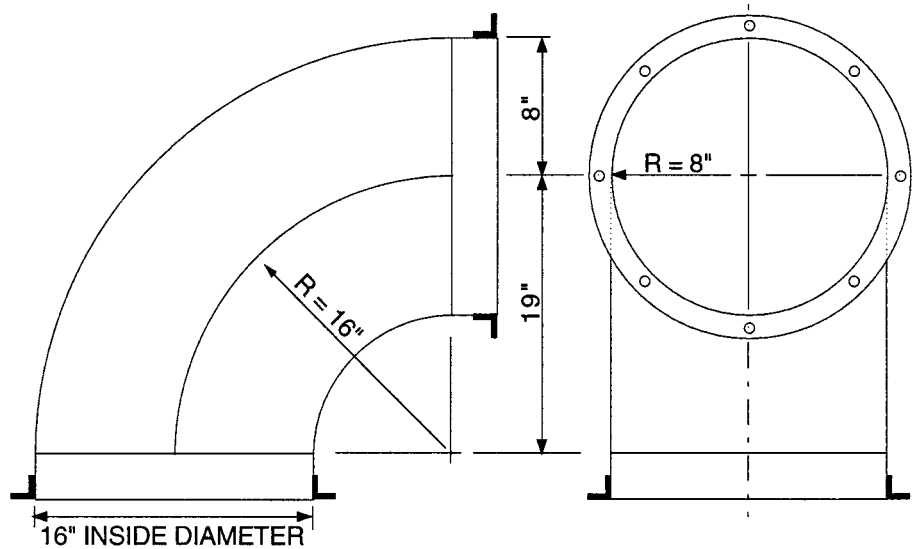

| <u>Inch-Pound Units</u> | <u>SI Units</u> |
|-------------------------|-----------------|
| 16 in.                  | 406.4 mm        |
| 8 in.                   | 203.2 mm        |
| 19 in.                  | 482.6 mm        |

FIG. 5 Typical Duct Elbow (Not a Construction Drawing)

5.1.9.1 A photometer system consisting of a lamp<sup>7</sup> and photocell<sup>8</sup> shall be mounted on a horizontal section of the 16-in. (406-mm) diameter vent pipe at a point where it will be preceded by a straight run of pipe (at least 12 diameters or 16 ft (4.88 m) and not more than 30 diameters or 40 ft (12.19 m) from the vent end of the chamber, and with the light beam directed upward along the vertical axis of the vent pipe. The vent pipe shall be insulated with at least 2 in. (51 mm) of high-temperature mineral composition material, from the vent end of the chamber to the photometer location. The photoelectric cell of which the output is directly proportional to the amount of light received shall be mounted over the light source and connected to a data acquisition device for indicating changes in the attenuation of incident light by the passing smoke, particulate, and other effluent. The distance between the light source lens and the photocell lens shall be  $36 \pm 4$  in. ( $914 \pm 102$  mm). The cylindrical light beam shall pass through 3-in. (76-mm) diameter openings at the top and bottom of the 16-in. diameter duct, with the resultant light beam centered on the photocell.

5.1.9.2 Linearity of the photometer system shall be verified periodically by interrupting the light beam with calibrated neutral density filters. The filters shall cover the full range of the recording instrument. Transmittance values measured by the photometer, using neutral density filters, shall be within  $\pm 3\%$  of the calibrated value for each filter.

5.1.10 *Draft Regulating Device:*

5.1.10.1 An automatically controlled damper to regulate the draft pressure shall be installed in the vent pipe down-stream of the smoke-indicating attachment. The damper shall be provided with a manual override.

5.1.10.2 Other manual or automatic draft regulation devices, or both, are allowed to be incorporated to help maintain fan characterization and air-flow control throughout the test.

5.1.11 *Thermocouples:*

5.1.11.1 A No. 18 Awg (1.02-mm) thermocouple, with  $\frac{3}{8} \pm \frac{1}{8}$  in. ( $9.5 \pm 3.2$  mm) of the junction exposed in the air, shall be inserted through the floor of the test chamber so that the tip is  $1 \pm \frac{1}{32}$  in. ( $25.4 \pm 0.8$  mm) below the top surface of the gasketing tape and  $23 \text{ ft} \pm \frac{1}{2}$  in. ( $7.0 \text{ m} \pm 13 \text{ mm}$ ) from the centerline of the burner ports at the center of its width.

5.1.11.2 Two No. 18 Awg (1.02 mm) thermocouples are embedded below the floor surface of the test chamber. These thermocouples shall be mounted at distances of  $13 \text{ ft} \pm \frac{1}{2}$  in. ( $3.96 \text{ m} \pm 13 \text{ mm}$ ) and  $23 \frac{1}{4} \text{ ft} \pm \frac{1}{2}$  in. ( $7.09 \text{ m} \pm 13 \text{ mm}$ ) measured from the centerline of the burner ports. The thermocouples shall be inserted from below the fire test chamber through the firebrick until the tip of the thermocouple is  $\frac{1}{8} \pm \frac{1}{32}$  in. ( $3.2 \pm 0.8$  mm) below the floor surface. The tip of the thermocouples shall be covered with refractory or portland cement, carefully dried to avoid cracking.

<sup>7</sup> The sole source of supply of the apparatus known to the committee at this time is 12-V sealed beam, clear lens, auto spot lamp, No. 4405, from General Electric, Nela Park, OH. If you are aware of alternative suppliers, please provide this information to ASTM Headquarters. Your comments will receive careful consideration at a meeting of the responsible technical committee, <sup>1</sup> which you may attend.

<sup>8</sup> The sole source of supply of the apparatus known to the committee at this time is No. 856BB from Weston Instruments, Wauconda, IL. If you are aware of alternative suppliers, please provide this information to ASTM Headquarters. Your comments will receive careful consideration at a meeting of the responsible technical committee, <sup>1</sup> which you may attend.

## 6. Test Specimens

6.1 Specimens shall be representative of the materials which the test is intended to examine. The report shall include information on the composition needed for identification of the test specimen as described in 11.1.1.

6.2 The specimen shall be provided in one of two ways: (1) a continuous, unbroken length; (2) sections that will be joined or butted end-to-end.

6.3 The size of the test specimen shall be:

Width: between 20 and 24 in. (508 and 610 mm)

Length: 24 ft + 12 in. — 6 in.

Thickness: maximum 4 in. (101 mm).

NOTE 1—The test apparatus is not designed for testing at thicknesses greater than 4 in. (101 mm), but has the ability to be modified if required. This is accomplished through (a) modifications to the test apparatus lid to maintain an airtight seal, and (b) the introduction, usually of additional sample/lid supports above the test apparatus ledges. Due to the composition of some materials, test results obtained at a thickness greater than 4 in. (101 mm) will potentially vary from results of a test on the same material tested at a thickness of 4 in. (101 mm) or less.

6.3.1 The test specimen shall not be required to conform to the test specimen length and width described in 6.3 when the material complies with 6.3.1.1-6.3.1.3.

NOTE 2—When tests are conducted with materials installed at less than full width, representing the end-use width, any resulting flame spread and smoke developed indices will not relate to indices obtained with the calibration material, which is tested using the specimen width described in 6.3.

6.3.1.1 Materials for which there is a standard practice to address specimen preparation and mounting with this test method shall be tested as described in the appropriate standard practice (see 6.8).

6.3.1.2 Adhesives, caulking, sealants, tapes and trim shall be permitted to be tested in the width or length, or both, specified in their listings, or as part of their conditions for being labeled, by a nationally recognized testing laboratory.

6.3.1.3 Materials and products for which there is a specific test method or application standard requiring the use of the apparatus described in Section 5 shall be permitted to be tested in accordance with that specific test method or application standard (see Appendix X5).

6.4 The test specimen shall be conditioned to a constant weight at a temperature of  $73.4 \pm 5^\circ\text{F}$  ( $23 \pm 2.8^\circ\text{C}$ ) and at a relative humidity of  $50 \pm 5\%$ .

6.5 The upstream end of the fire test chamber shall be filled with a  $14 \pm \frac{1}{8}$  —in. ( $356 \pm 3$  mm) length of uncoated 16-gauge (0.053 to 0.060 in.) steel plate positioned on the specimen mounting ledge in front of and under the leading edge of the specimen.

6.6 When the overall length of the test specimen exceeds 24 ft. (7.32 m), butt one end of the test specimen against the exhaust end of the fire test chamber and continue the installation of the specimen toward the gas burner.

6.7 When the overall length of the test specimen is 24 ft. (7.32 m) or less, provide a 1 in. (25 mm) overlap of the steel plate at the upstream end with one end of the test specimen and continue the installation of the specimen toward the exhaust end.

6.8 In addition to the above provisions, the standard practices listed below shall be used for specimen preparation and mounting of the relevant test materials. For all other products, guidance on mounting methods is provided in Appendix X1. e84-10

E2231 for pipe and duct insulation materials.

E2404 for paper, vinyl and textile wall and ceiling covering materials.

E2573 for site-fabricated stretch systems.

E2579 for the following wood products: solid board, lumber and timber products (including solid boards, lumber, timber, fingerjoined lumber, glulam, laminate wood, laminated veneer lumber and parallel strand lumber products), panel products (including fibreboard, hardboard, oriented strandboard, waferboard, and plywood panel products), decorative wood products (including fine woodwork, millwork and moulding) and shingles and shakes used as interior wall and ceiling finish and interior trim.

E2599 for Reflective Insulation Materials and Radiant Barrier Materials for Building Applications

## 7. Calibration

7.1 Place a nominal  $\frac{1}{4}$ -in. (6.3-mm) fiber-cement board meeting the properties of Annex A3 on the ledge of the furnace chamber. Place the removable lid of the test chamber in position.

7.2 With the  $\frac{1}{4}$ -in. (6.3-mm) fiber-cement board in position on top of the ledge of the furnace chamber and with the removable lid in place, establish a draft to produce a 0.15-in. (3.8-mm) water-column reading on the draft manometer, with the fire-end shutter open  $3 \pm \frac{1}{16}$  in. ( $76 \pm 1.5$  mm), by manually setting the damper as a characterization of fan performance. Then close and seal the fire-end shutter, without changing the damper position. The manometer reading shall increase to at least 0.375 in. (9.53 mm), indicating that no excessive air leakage exists.

7.2.1 In addition, conduct a supplemental leakage test periodically with the tunnel sealed from the inlet end to beyond the photometer system, by placing a smoke bomb in the chamber. Ignite the bomb and pressurize the chamber to  $0.375 \pm 0.125$  in. ( $9.53 \pm 3.18$  mm) water column. Seal all points of leakage observed in the form of escaping smoke particles.

7.3 Establish a draft reading within the range 0.055 to 0.100 in. (1.40 to 2.54 mm) water column. The required draft gage reading will be maintained throughout the test by the automatically controlled damper. Record the air velocity at seven points, 23 ft from the centerline of the burner ports,  $6 \pm \frac{1}{4}$  in. ( $168 \pm 7$  mm) below the plane of the specimen mounting ledge. Determine



these seven points by dividing the width of the tunnel into seven equal sections and recording the velocity at the geometrical center of each section. During the measurement of velocity, remove the turbulence bricks (see 4.3) and the exposed 23-ft thermocouple and place 24-in. (670-mm) long straightening vanes between 16 and 18 ft (4.88 and 5.49 m) from the burner. The straightening vanes shall divide the furnace cross section into nine uniform sections. Determine the velocity with furnace air temperature at  $73.4 \pm 5^\circ\text{F}$  ( $23 \pm 2.8^\circ\text{C}$ ), using a velocity transducer. The velocity, determined as the arithmetic average of the seven readings, shall be  $240 \pm 5$  ft ( $73.2 \pm 1.4$  m)/min.

7.3.1 The following alternative to the velocity transducer equipment and method of determining the tunnel air velocity has been found suitable: A 4-in. diameter low-speed rotary vane anemometer, having a resolution of 1 ft./min. with an accuracy of  $\pm 2\%$ , is attached to the steel stand and placed in the tunnel 22.5 ft downstream of the burners. Three trials shall be conducted and their values averaged. The average is rounded to the nearest unit. The centerline of the vane anemometer shall be aligned with the vertical centerline of the tunnel by placing it on the steel stand. Trial 1 is run with the vane edge 1 in. from the non-window wall; Trial 2 is with the center axis at the tunnel center point; and Trial 3 is run with the vane edge 1 in. from the window wall.

7.4 The room in which the test chamber is located shall have provision for a free inflow of air during test to maintain the room at atmospheric pressure during the entire test run. Maintain the air supply at a temperature of  $73.4 \pm 5^\circ\text{F}$  ( $23 \pm 2.8^\circ\text{C}$ )  ~~$65\text{--}80^\circ\text{F}$  ( $18.3\text{--}26.7^\circ\text{C}$ )~~ and a relative humidity of  $50 \pm 5\%$   ~~$45\text{--}60\%$~~ .

7.5 Supply the fire test chamber with natural (city) or methane (bottled) gas fuel of uniform quality with a heating value of nominally 1000 Btu/ft<sup>3</sup> (37.3 MJ/m<sup>3</sup>). Adjust the gas supply initially at approximately 5000 Btu (5.3 MJ)/min. Record the gas pressure, the pressure differential across the orifice plate, and the volume of gas used in each test. If a temperature- and pressure-compensating mass flowmeter is utilized, record only the volume of gas used. Unless otherwise corrected for, when bottled methane is employed, insert a length of coiled copper tubing into the gas line between the supply and metering connection to compensate for possible errors in the flow indicated due to reductions in gas temperature associated with the pressure drop and expansion across the regulator. With the draft and gas supply adjusted as indicated in 7.3 and 7.4, the test flame shall extend downstream to a distance of 4½ ft (1.37 m) over the specimen surface, with negligible upstream coverage.

7.6 Preheat the test chamber with the ¼-in. (6.3-mm) fiber-cement board and the removable lid in place and with the fuel supply adjusted to the required flow. Continue the preheating until the temperature indicated by the floor thermocouple at 23¼ ft (7.09 m) reaches  $150 \pm 5^\circ\text{F}$  ( $66 \pm 2.8^\circ\text{C}$ ). During the preheat test, record the temperatures indicated by the thermocouple at the vent end of the test chamber at intervals not longer than 15 s and compare these readings to the preheat temperature shown in the time-temperature curve in Fig. 6. This preheating is for the purpose of establishing the conditions that will exist following successive tests and for indicating the control of the heat input into the test chamber. If appreciable variation from the temperatures shown in the representative preheat curve is observed, suitable adjustments in the fuel supply may be necessary based on red oak calibration tests.

7.7 Allow the furnace to cool after each test. When the floor thermocouple at 13 ft (3.96 m) shows a temperature of  $105 \pm 5^\circ\text{F}$  ( $40.5 \pm 2.8^\circ\text{C}$ ), place the next specimen in position for test.

7.8 With the test equipment adjusted and conditioned as described in 7.2, 7.3, 7.4, and 7.6, make a test or series of tests, using nominal 2¾-in. (18-mm) select-grade red oak flooring samples and samples of ¼-in. (6-mm) fiber-cement board. Conduct these tests in either order.

7.8.1 The red oak decks are to be constructed and conditioned as specified in Annex A1 and Annex A2. Make observations at distance intervals not in excess of 2 ft (0.6 m) and time intervals not in excess of 30 s, and record the time when the flame reaches the end of the specimen 19½ ft (5.94 m) from the end of the ignition fire. The end of the ignition fire shall be considered as being 4½ ft (1.4 m) from the burners. The flame shall reach the end point in 5½ min  $\pm$  15 s. Automatically record the temperature measured by the exposed thermocouple at 23 ft. (7.0 m) at least every 15 s. Automatically record the photoelectric cell output immediately prior to the test and at least every 15 s during the test.

7.8.2 Another means of judging when the flame has reached the end point is when the exposed thermocouple at 23 ft (7.0 m) registers a temperature of 980°F (527°C).

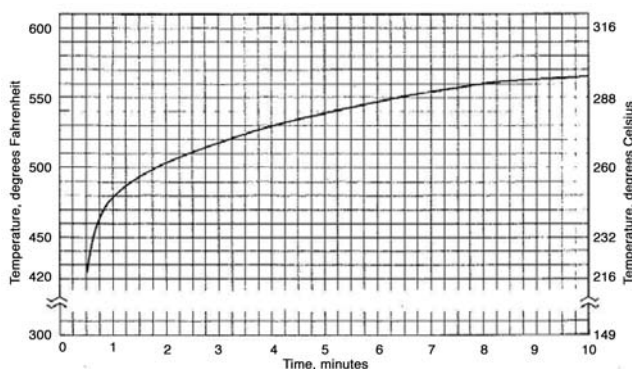

FIG. 6 Representative Time-Temperature Curve for Preheat Temperatures

7.9 Plot the flame spread distance, temperature, and change in photoelectric cell readings for the duration of the test. Figs. 7-9 are representative curves for red oak flame spread distance, time-temperature development, and smoke density, respectively. Flame spread distance shall be determined as the observed distance minus 4½ ft (1.37 m).

7.10 Conduct a similar test or tests on samples of ¼-in. (6-mm) fiber-cement board. These results shall be considered as representing an index of 0. Plot the temperature readings for the duration of the test. Fig. 10 is a representative curve for time-temperature development for fiber-cement board.

7.11 The calibrations described in Section 7 shall be performed after major repairs, such as re-bricking, have been made. If there have been no major repairs, new calibrations shall be conducted after 200 tests, or every 12 months, whichever comes first.

7.12 The red oak flame spread calibration data shall be used to confirm performance indicated in 7.8, that the flame reaches the end of the specimen at a time no less than 5 min 15 s and no more than 5 min 45 s from the start of the test. In the event that the flame reaches the end of the specimen outside these time limits, make adjustments and recalibrate until the correct time is achieved.

7.13 Add the data from the new red oak smoke calibration to a data set containing the last four calibrations in order to maintain a running average of at least five calibrations. This average of smoke-developed index (SDI) data shall provide the calibration data to be used to adjust the settings for the equipment and to establish areas for calculation of the SDI. When fewer than five calibrations have been performed on new equipment, average the available number of calibrations to achieve the running average.

**8. Procedure**

8.1 With the furnace draft operating, place the test specimen on the test chamber ledges that have been completely covered with nominal ⅛-in. (3.2-mm) thick by 1½-in. (38-mm) wide woven gasketing tape. Place the specimen as quickly as is practical. Place the removable top in position over the specimen.

8.2 Keep the completely mounted specimen in position in the chamber with the furnace draft operating for 120 ± 15 s prior to the application of the test flame.

8.3 Ignite the burner gas. Observe and record the distance and time of maximum flame front travel with the room darkened. Continue the test for a 10-min period. Termination of the test prior to 10 min is permitted if the specimen is completely consumed in the fire area and no further progressive burning is evident and the photoelectric cell reading has returned to the baseline.

8.4 Record the photoelectric cell output immediately prior to the test and at least every 2 s during the test.

8.5 Record the gas pressure, the pressure differential across the orifice plate, and the volume of gas used in each test. If a temperature- and pressure-compensating mass flowmeter device is used to monitor the gas flow, record only the volume of gas.

8.6 When the test is ended, shut off the gas supply, observe smoldering and other conditions within the test duct, and remove the specimen for further examination.

8.7 Plot the flame spread distance, temperature, and change in photoelectric cell readings for the duration of the test for use in determining the flame-spread and smoke-developed indexes as outlined in Section 9. Flame front advancement shall be recorded at the time of occurrence or at least every 30 s if no advancement is noted. Flame spread distance shall be determined as the observed distance minus 4½ ft (1.37 m).

**9. Interpretation of Results**

9.1 The flame spread index (FSI) shall be the value, determined as follows, rounded to the nearest multiple of five.

9.1.1 In plotting the flame spread distance-time relationship, all progressive flaming as previously recorded shall be included at the time of occurrence. A straight line shall be used to connect successive points. The total area ( $A_T$ ) under the flame spread

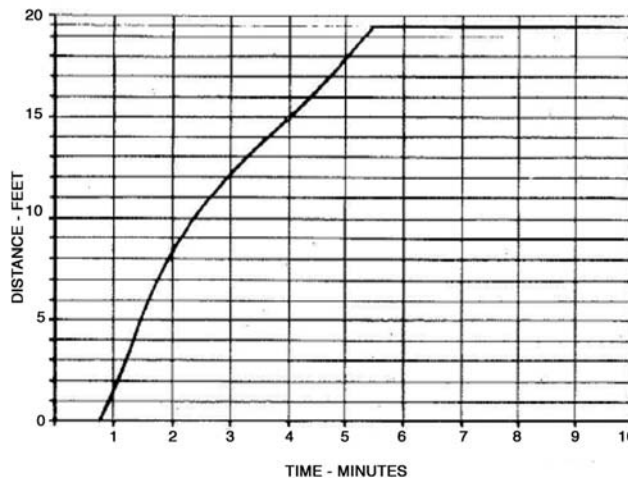

FIG. 7 Representative Time-Distance Curve for Flame Spread of Red Oak