



Standard Test Methods for Thickness and Density of Sprayed Fire-Resistive Material (SFRM) Applied to Structural Members¹

This standard is issued under the fixed designation E 605; the number immediately following the designation indicates the year of original adoption or, in the case of revision, the year of last revision. A number in parentheses indicates the year of last reapproval. A superscript epsilon (ϵ) indicates an editorial change since the last revision or reapproval.

1. Scope

1.1 These test methods cover procedures for determining thickness and density of sprayed fire-resistive material (SFRM) used in structural assemblies. These include sprayed fiber and cementitious types. The test methods are applicable to both laboratory and field procedures, as indicated in Section 7.

1.2 These test methods require the application of SFRM in accordance with the manufacturers' published instructions. The apparatus, materials, and procedure used to apply the SFRM for laboratory tests shall be the same as is used for the construction of either of the test assemblies described in Test Methods E 119 and E 84.

1.3 There is no intent in these test methods to establish levels of performance.

1.4 *This standard does not purport to address all of the safety concerns, if any, associated with its use. It is the responsibility of the user of this standard to establish appropriate safety and health practices and determine the applicability of regulatory limitations prior to use.*

2. Referenced Documents

2.1 ASTM Standards:

- E 84 Test Method for Surface Burning Characteristics of Building Materials²
- E 119 Test Methods for Fire Tests of Building Construction and Materials²
- E 631 Terminology of Building Constructions³

3. Terminology

3.1 *Definitions*—For definitions of terms found in these test methods, refer to Terminology E 631.

3.2 *Definitions of Terms Specific to This Standard:*

3.2.1 *density, n*—the weight⁴ per unit volume of the SFRM.

3.2.2 *sprayed fire-resistive materials, n*—materials that are sprayed onto substrates to provide fire-resistive protection of the substrates.

3.2.3 *thickness, n*—the distance measured from the substrate sprayed with the SFRM, through the SFRM, to the outer surface of the SFRM.

4. Summary of Test Methods

4.1 The basic properties of density and thickness are determined using a thickness gage, scales, steel rules, and templates.

5. Significance and Use

5.1 Certain properties, namely thickness and density, of SFRM are basic. It is the intent of these test methods to provide procedures to determine these properties.

6. Apparatus

6.1 *Steel Rule*, graduated in at least 1 mm ($1/16$ in.) intervals.

6.2 *Thickness Gage*, consisting of a needle or a pin and a sliding disk perpendicular to the needle (see Fig. 1). The pin shall be of sufficient length for the thickness of the material to be measured. This gage shall be graduated in 1 mm ($1/16$ in.) intervals. This disk shall be perpendicular to the needle at all times and shall have a friction device to grip the pin unless purposely moved. The disk diameter shall be a minimum of 22 mm ($7/8$ in.) and a maximum of 30 mm ($1\frac{1}{8}$ in.), to permit contact with the surface of the specimen to be measured. For materials not readily penetrated by the depth gage, see 8.1.2.1 and Note 2.

6.3 *Scales* of sufficient capacity and sensitivity to weigh the test specimen to an accuracy of at least 0.1 g.

6.4 *Rectangular Template* of predetermined length and width having a minimum area of 310 cm² (48 in.²). No dimension shall be less than 76 mm (3 in.).

6.5 *Knife*, or other suitable device for cutting the specimen.

6.6 *Drying Oven*, or other device capable of maintaining temperature and humidity conditions during the specimen curing cycle, in accordance with the SFRM manufacturer's requirements. (See Section 7.2.)

6.7 *Unexpanded Polystyrene Beads*, 500 mL—Designation C Bead with a nominal diameter of 1.0 mm (0.04 in.) (preferred) or lead shot—size #8 (alternate).

¹ These test methods are under the jurisdiction of ASTM Committee E06 on Performance of Buildings and is the direct responsibility of Subcommittee E06.21 on Serviceability.

Current edition approved April 15, 1993. Published June 1993. Originally published as E 605-77. Last previous edition E 605-77 (1982).

² *Annual Book of ASTM Standards*, Vol 04.07.

³ *Annual Book of ASTM Standards*, Vol 04.11.

⁴ Although *mass* is determined, the term *weight* is used in these test methods as a field-accepted substitute.

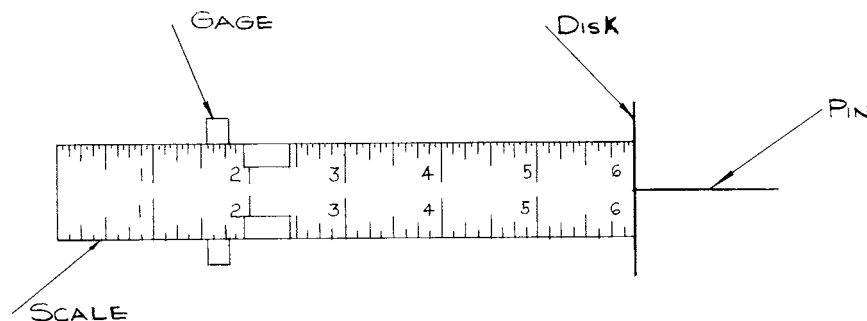

FIG. 1 Thickness Gage

6.8 *Graduated Cylinders*, two 250 cm³.

6.9 *Funnel*—Polypropylene funnel having a top diameter of 150 mm (6 in.) and a bottom diameter of 28 mm (1.1 in.).

6.10 *Beaker*, 400 mL smooth wall type.

6.11 *Screed*, minimum 150 mm (6 in.) long rigid straight edge.

6.12 *Pan*—Two flat pans minimum 150 mm (6 in.) diameter with minimum 150 mm high rim.

7. Test Specimen

7.1 Laboratory Tests:

7.1.1 The test specimens shall be SFRM applied to 1.5 mm (0.06 in. (16 ga.)), 400 by 400 mm (16 by 16 in.) bare or galvanized steel plates.

7.1.2 The specimens shall be conditioned for a period of not less than 72 h at room temperature, 20° ± 5°C (68° ± 9°F) and a relative humidity not greater than 60 %, until successive weight readings, taken at 24 h intervals, differ by less than 1 %.

7.2 Field Tests:

7.2.1 As an alternate to 7.1.2, the specimens shall be force dried at a temperature of 43° ± 6°C (109° ± 10°F) and a relative humidity not greater than 60 % until successive readings, taken at 8 h intervals, differ by less than 1 %.

8. Procedure

8.1 Thickness:

8.1.1 Selected areas to be measured for thickness shall be a predetermined, repetitive pattern to ensure obtaining representative average thickness.

8.1.2 Determine the thickness by inserting the penetrating pin of the thickness gage perpendicular to and through the SFRM, to the substrate. When the point of the pin touches the substrate, move the sliding disk to the SFRM surface with sufficient force on the disk to register the average plane of the surface. Withdraw the gage to read the thickness in 1 mm (1/16 in.) increments as shown by the position of the sliding clip indicator.

8.1.2.1 For the purpose of averaging measurements, any measurement 6 mm (1/4 in.) or more, over the required design thickness, shall be recorded as the design thickness plus 6 mm. No individual measured thickness shall be more than 6 mm less, or more than 25 % less, than the required design thickness.

NOTE 1—Specific fire resistance rating criteria for beams, trusses, and columns may allow for a reduced thickness on flange tips. These thicknesses are to be averaged apart from other sections of the structural

member. Also, some fire rating assemblies have different thickness requirements for crests and valleys of floor decks and should be averaged apart.

NOTE 2—Medium and high density SFRM may be too hard to test for thickness by standard procedure. It is recommended to check thicknesses immediately after application, and before curing.

The applicator shall adjust the thickness of the freshly applied SFRM to yield thickness after cure, in accordance with the SFRM manufacturer's recommendations.

If the product is cured and too hard to insert the thickness gage, drill small diameter holes into the product just large enough to accommodate the thickness gage pin. The thickness gage is then inserted into these holes and thickness is determined by the standard procedure. These holes are to be closed off immediately following the test using the same SFRM.

8.1.3 *Conducting Thickness Testing*—One bay per floor or one bay for each 10 000 ft², whichever provides the greater number of tests. Thickness determinations for the following structural elements shall be conducted in each randomly selected bay: one selected area of metal deck, concrete slab, or wall section; one column; and one beam (joist or truss).

NOTE 3—The applicable building code governs. Consult the applicable building code for exact requirements and tolerances.

8.1.4 Tests for the Deck and Wall Section:

8.1.4.1 *Flat Decks*—In the preselected area, lay out a 300 mm (12 in.) square. Take four random symmetrical measurements within that square and report as an average. (See Note 1.)

8.1.4.2 *Fluted Decks*—In the preselected area, lay out a 300 mm (12 in.) square. Take four random symmetrical measurements within that square, one each of the following: valley, crest, and sides, and report as an average. (See Note 1.)

8.1.5 Test for Beams, Joists (Trusses), and Columns:

8.1.5.1 *Beams*—For each preselected beam, lay out one 300 mm (12 in.) length and take nine thickness measurements (see Fig. 2) at each end of the 300 mm length (see Fig. 3). (See Notes 1 and 2.)

8.1.5.2 *Joists (Trusses)*—For each preselected joist (truss), lay out one 300 mm (12 in.) length and take seven thickness measurements (see Fig. 4) at each end of the 300 mm length (see Fig. 5). (See Notes 1 and 2.)

8.1.5.3 *Columns*—For each preselected column, lay out one 300 mm (12 in.) length and take twelve thickness measurements (see Fig. 6) at each end of the 300 mm length (see Fig. 7). (See Notes 1 and 2.)

8.1.5.4 *Beams, Joists (Trusses), and Columns*—Average, separately, the 18 thickness measurements for the beams, the 14 thickness measurements for the joists (trusses), and the 24

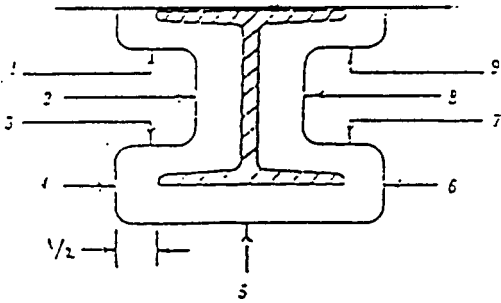
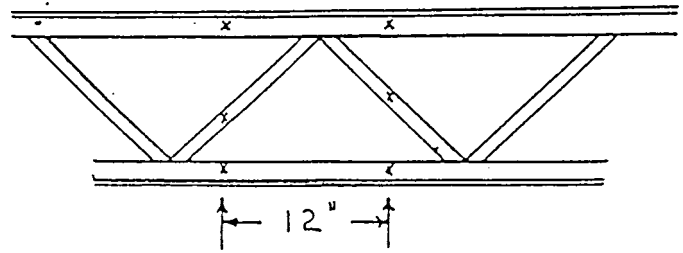
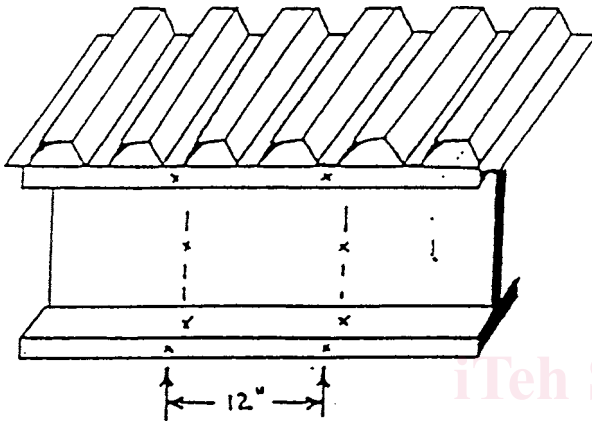

FIG. 2 Test Locations for Measuring Thickness of Fire-Resistive Materials on Beams



NOTE 1—Take 7 measurements at each end of 12 in. length.
FIG. 5 Joist



NOTE 1—Take nine measurements at each end of 12 in. length.
FIG. 3 Beam

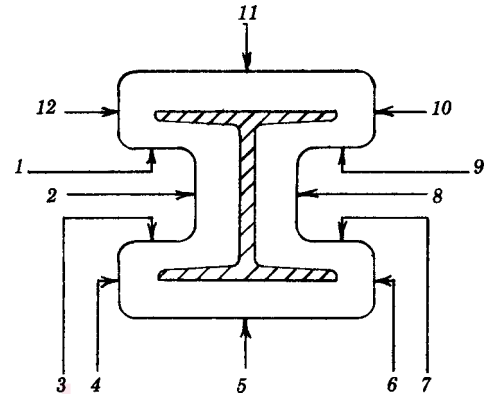

FIG. 6 Test Locations for Measuring Thickness of Fire-Resistive Materials on Beams and Columns

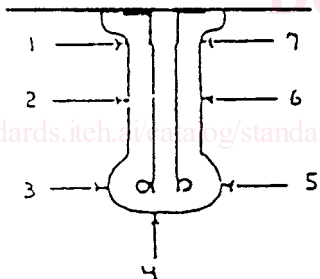
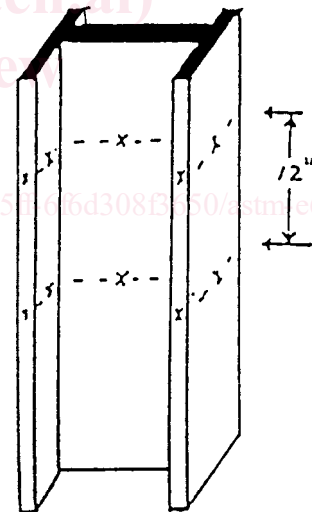

FIG. 4 Test Locations for Measuring Thickness of Fire-Resistive Materials on Joists (Trusses)



NOTE 1—Take 12 measurements at each end of 12 in. length.
FIG. 7 Column

thickness measurements for the columns. (A sample data sheet is shown in Fig. 8.) (See Notes 1 and 2.)

8.1.6 *Thickness Deficiency*—An item (deck, column, beam, or joist) is deficient if:

8.1.6.1 An individual measured thickness is more than 6 mm (1/4 in.) less, or more than 25 % less, than the required fire resistance design thickness. (See Note 3.)

8.1.6.2 The calculated average thickness of the SFRM is less than that required by the design.

NOTE 4—A thickness to density correction formula is contained in certain fire resistance rating criteria or is available from some SFRM manufacturers. Consult the rating criteria and the SFRM manufacturer for specific information before deficiency.

NOTE 5—If an item is deficient, then only that specific item fails. The remaining items in the bay, and like items in other areas of the building, shall not be deemed to have failed solely because the tested item has failed. (See 8.1.7.)

8.1.7 *Procedure in Case of Deficiency*— If an item is deficient, then it shall be corrected and retested, along with another of that specific item (that is, another column, if a column has failed, etc.) selected at random.

8.2 *Density:*

8.2.1 Conduct one density test at random on each of the following protected elements, per floor or per every 930 m²(10 000 ft²), whichever provides the greatest number of tests: the flat portion of the deck; a beam, either the bottom of