



Designation: E587-00 (Reapproved 2005) Designation: E587 – 10

Standard Practice for ~~Ultrasonic Angle-Beam Examination by the Contact Method~~ Ultrasonic Angle-Beam Contact Testing¹

This standard is issued under the fixed designation E587; the number immediately following the designation indicates the year of original adoption or, in the case of revision, the year of last revision. A number in parentheses indicates the year of last reapproval. A superscript epsilon (ϵ) indicates an editorial change since the last revision or reapproval.

1. Scope

1.1 This practice covers ultrasonic examination of materials by the pulse-echo technique, using continuous coupling of angular incident ultrasonic vibrations.

~~1.2 The values stated in inch-pound units are regarded as standard. The SI equivalents are in brackets and may be approximate.~~

~~1.3 This practice shall be applicable to development of an examination procedure agreed upon by the users of the practice.~~

1.3 The values stated in inch-pound units are regarded as standard. The values given in parentheses are mathematical conversions to SI units that are provided for information only and are not considered standard.

1.4 *This standard does not purport to address all of the safety concerns, if any, associated with its use. It is the responsibility of the user of this standard to establish appropriate safety and health practices and determine the applicability of regulatory limitations prior to use.*

2. Referenced Documents

2.1 ASTM Standards:²

E114 Practice for Ultrasonic Pulse-Echo Straight-Beam Contact Testing

E317 Practice for Evaluating Performance Characteristics of Ultrasonic Pulse-Echo Testing Instruments and Systems without the Use of Electronic Measurement Instruments

E543 Specification for Agencies Performing Nondestructive Testing

E1316 Terminology for Nondestructive Examinations

2.2 ASNT Documents:³

SNT-TC-1A Recommended Practice for Nondestructive Testing Personnel Qualification and Certification

ANSI/ASNT CP-189 Standard for Qualification and Certification of Nondestructive Testing Personnel

2.3 Military Standards:⁴

MIL-STD-410 Nondestructive Testing Personnel Qualification and Certification

2.4 Aerospace Industries Association Document:⁵

NAS 410 Certification and Qualification of Nondestructive Testing Personnel

3. Terminology

3.1 *Definitions*—For definitions of terms used in this practice, see Terminology E1316.

4. Significance and Use

4.1 An electrical pulse is applied to a piezoelectric transducer which converts electrical to mechanical energy. In the angle-beam search unit, the piezoelectric element is generally a thickness expander which creates compressions and rarefactions. This longitudinal (compressional) wave travels through a wedge (generally a plastic). The angle between transducer face and the examination face of the wedge is equal to the angle between the normal (perpendicular) to the examination surface and the incident

¹ This practice is under the jurisdiction of ASTM Committee E07 on Nondestructive Testing and is the direct responsibility of Subcommittee E07.06 on Ultrasonic Method. Current edition approved January 1, 2005-2010. Published January 2005-July 2010. Originally approved in 1976. Last previous edition approved in 2000-2005 as E587 - 00(2005). DOI: 10.1520/E0587-00R05-10.1520/E0587-10.

² For referenced ASTM standards, visit the ASTM website, www.astm.org, or contact ASTM Customer Service at service@astm.org. For Annual Book of ASTM Standards volume information, refer to the standard's Document Summary page on the ASTM website.

³ Available from The American Society for Nondestructive Testing (ASNT), P.O. Box 28518, 1711 Arlington Lane, Columbus, OH 43228-0518, <http://www.asnt.org>.

⁴ Available from Standardization Documents Order Desk, DODSSP, Bldg. 4, Section D, 700 Robbins Ave., Philadelphia, PA 19111-5094, Attn: NPODS-19111-5098, <http://dodssp.daps.dla.mil>.

⁵ Available from Aerospace Industries Association of America, Inc., 1250 Eye St. NW, Washington D.C. 20005.

⁶ Available from Aerospace Industries Association of America, Inc. (AIA), 1000 Wilson Blvd., Suite 1700, Arlington, VA 22209-3928, <http://www.aia-aerospace.org>.

beam. Fig. 1 shows the incident angle ϕ_i , and the refracted angle ϕ_r , of the ultrasonic beam.

4.2 When the examination face of the angle-beam search unit is coupled to a material, ultrasonic waves may travel in the material. As shown in Fig. 2, the angle in the material (measured from the normal to the examination surface) and mode of vibration are dependent on the wedge angle, the ultrasonic velocity in the wedge, and the velocity of the wave in the examined material. When the material is thicker than a few wavelengths, the waves traveling in the material may be longitudinal and shear, shear alone, shear and Rayleigh, or Rayleigh alone. Total reflection may occur at the interface. (Refer to Fig. 3.) In thin materials (up to a few wavelengths thick), the waves from the angle-beam search unit traveling in the material may propagate in different Lamb wave modes.

4.3 All ultrasonic modes of vibration may be used for angle-beam examination of material. The material forms and the probable flaw locations and orientations determine selection of beam directions and modes of vibration. The use of angle beams and the selection of the proper wave mode presuppose a knowledge of the geometry of the object; the probable location, size, orientation, and reflectivity of the expected flaws; and the laws of physics governing the propagation of ultrasonic waves. Characteristics of the examination system used and the ultrasonic properties of the material being examined must be known or determined. Some materials, because of unique microstructure, are difficult to examine using ultrasonics. Austenitic material, particularly weld material, is one example of this material condition. Caution should be exercised when establishing examination practices for these type materials. While examination may be possible, sensitivity will be inferior to that achievable on ferritic materials. When examining materials with unique microstructures, empirical testing should be performed to assure that the examination will achieve the desired sensitivity. This may be accomplished by incorporating known reflectors in a mock up of the weld or part to be examined.

4.3.1 *Angle-Beam Longitudinal Waves*—As shown in Fig. 4, angle-beam longitudinal waves with refracted angles in the range from 1 to 40° (where coexisting angle-beam shear waves are weak, as shown in Fig. 3) may be used to detect fatigue cracks in axles and shafts from the end by direct reflection or by corner reflection. As shown in Fig. 5, with a crossed-beam dual-transducer search unit configuration, angle-beam longitudinal waves may be used to measure thickness or to detect reflectors parallel to the examination surface, such as laminations. As shown in Fig. 6, reflectors with a major plane at an angle up to 40° with respect to the examination surface, provide optimum reflection to an angle-beam longitudinal wave that is normal to the plane of the reflector. Angle-beam longitudinal waves in the range from 45 to 85° become weaker as the angle increases; at the same time, the coexisting angle-beam shear waves become stronger. Equal amplitude angle beams of approximately 55° longitudinal wave and 29° shear wave will coexist in the material, as shown in Fig. 7. Confusion created by two beams traveling at different angles and at different velocities has limited use of this range of angle beams.

4.3.2 *Angle-Beam Shear Waves (Transverse Waves)*—Angle-beam shear waves in the range from 40 to 75° are the most used angle beams. They will detect imperfections in materials by corner reflection and reradiation (as shown in Fig. 8) if the plane of the reflector is perpendicular to a material surface, and by direct reflection if the ultrasonic beam is normal to the plane of the reflector (as shown in Fig. 9). Reflectors parallel to the examination surface (such as laminations in plate, as shown in Fig. 10) can rarely be detected by an angle beam unless accompanied by another reflector; for example, a lamination at the edge of a plate (as shown in Fig. 11) can be detected by corner reflection from the lamination and plate edge. Generally, laminations should be detected and evaluated by the straight-beam technique. Angle-beam shear waves applied to weld testing will detect incomplete penetration (as shown in Fig. 12) by corner reflection, incomplete fusion (as shown in Fig. 13) by direct reflection (when the beam angle is chosen to be normal to the plane of the weld preparation), slag inclusion by cylindrical reflection (as shown in Fig. 14), porosity by spherical reflection, and cracks (as shown in Fig. 15) by direct or corner reflection, depending on their orientation. Angle-beam shear waves of 80 to 85° are frequently accompanied by a Rayleigh wave traveling on the surface. Confusion created by two beams at slightly different angles, traveling at different velocities, has limited applications in this range of angle beams.

4.3.3 *Surface-Beam Rayleigh Waves*—Surface-beam Rayleigh waves travel at 90° to the normal of the examination surface on the examination surface. In material greater than two wavelengths thick, the energy of the Rayleigh wave penetrates to a depth of approximately one wavelength; but, due to the exponential distribution of the energy, one half of the energy is within one-quarter wavelength of the surface. Surface cracks with length perpendicular to the Rayleigh wave can be detected and their depth evaluated

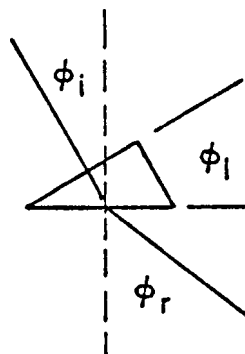

FIG. 1 Refraction

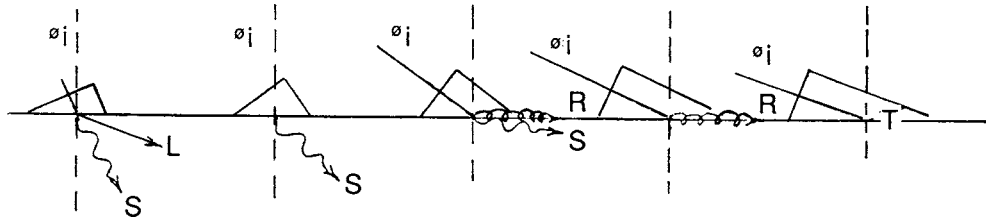

FIG. 2 Mode of Vibration

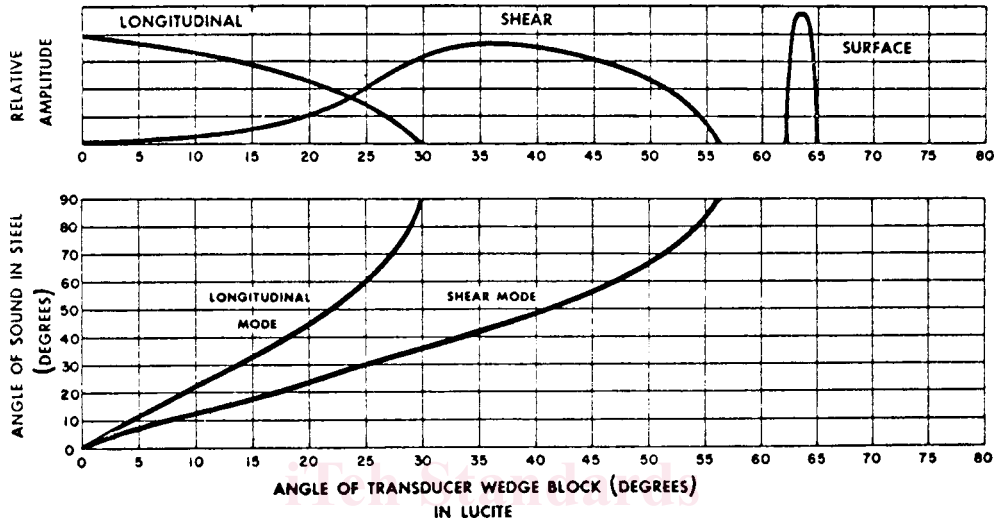

FIG. 3 Effective Angles in the Steel versus Wedge Angles in Acrylic Plastic

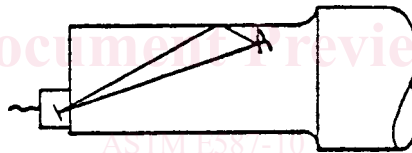

FIG. 4 Axle

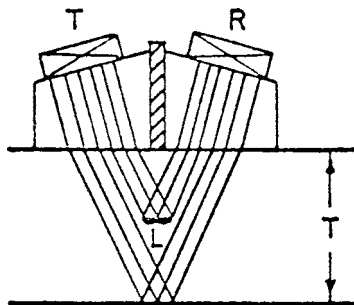

FIG. 5 Thickness

by changing the frequency of the Rayleigh wave, thus changing its wavelength and depth of penetration. Wavelength equals velocity divided by frequency.

$$\lambda = \frac{V}{f}$$

Subsurface reflectors may be detected by Rayleigh waves if they lie within one wavelength of the surface.

4.3.4 *Lamb Waves*—Lamb waves travel at 90° to the normal of the test surface and fill thin materials with elliptical particle vibrations. These vibrations occur in various numbers of layers and travel at velocities varying from slower than Rayleigh up to nearly longitudinal wave velocity, depending on material thickness and examination frequency. Asymmetrical-type Lamb waves have an odd number of elliptical layers of vibration, while symmetrical-type Lamb waves have an even number of elliptical layers of vibration. Lamb waves are most useful in materials up to five wavelengths thick (based on Rayleigh wave velocity in a thick

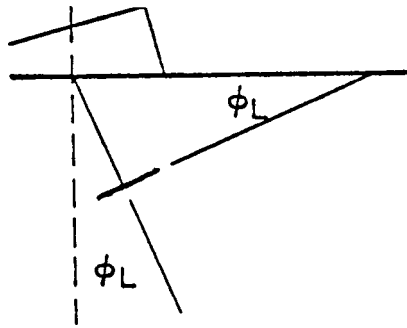

FIG. 6 Angle Longitudinal

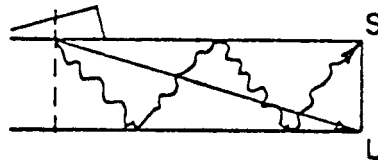

FIG. 7 Coincident Beams

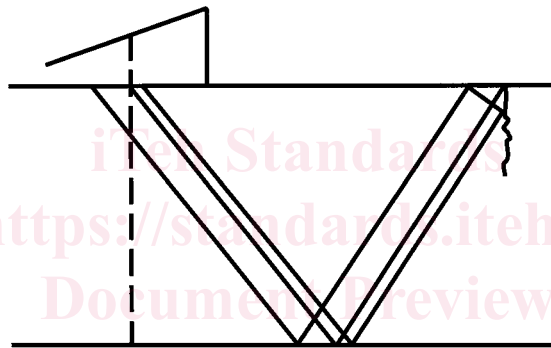

FIG. 8 Corner

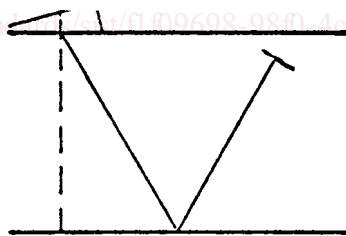

FIG. 9 Normal Plane

specimen of the same material). They will detect surface imperfections on both the examination and opposite surfaces. Centrally located laminations are best detected with the first or second mode asymmetrical Lamb waves (one or three elliptical layers). Small thickness changes are best detected with the third or higher mode symmetrical or asymmetrical-type Lamb waves (five or more elliptical layers). A change in plate thickness causes a change of vibrational mode just as a lamination causes a mode change. The mode conversion is imperfect and may produce indications at the leading and the trailing edges of the lamination or the thin area.

5. Basis of Application

5.1 *Purchaser-Supplier Agreements:* The following items require agreement between using parties for this practice to be used effectively:

5.1.1 *Personnel Qualification*—If specified in the contractual agreement, personnel performing examinations to this practice shall be qualified in accordance with a nationally recognized NDT personnel qualification practice or standard such as ANSI/ASNT-CP-189, SNT-TC-1A, MIL STD-410, NAS-410, or a similar document and certified by the employer or certifying agency, as applicable. The practice or standard used and its applicable revision shall be identified in the contractual agreement between the using parties.

NOTE 1—MIL STD-410 is canceled and has been replaced with NAS-410, however, it may be used with agreement between contracting parties.

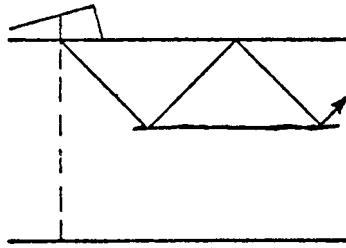

FIG. 10 Laminar

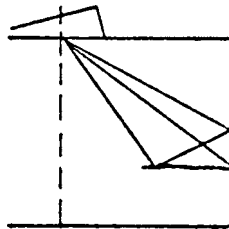

FIG. 11 Edge Lamination

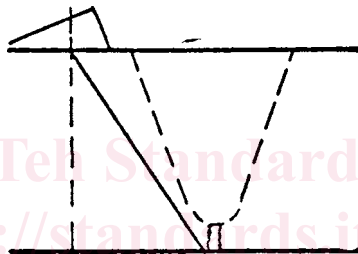

FIG. 12 Incomplete Penetration

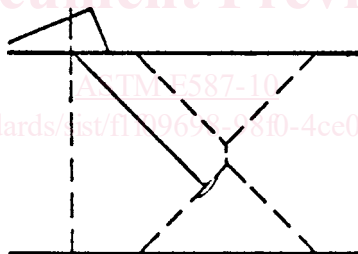

FIG. 13 Incomplete Fusion

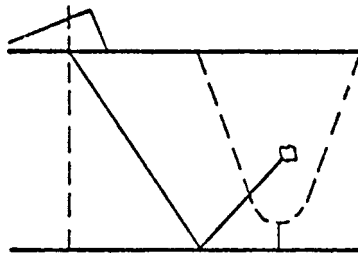

FIG. 14 Slag and Porosity

5.1.2 *Qualification of Nondestructive Agencies*—If specified in the contractual agreement, NDT agencies shall be qualified and evaluated as described in Practice Specification E543. The applicable edition of Practice Specification E543 shall be specified in the contractual agreement.

5.2 For material with unique microstructures as described in 4.3, a technique and procedure shall be agreed upon between contracting parties.

6. Apparatus

6.1 A complete ultrasonic system shall include the following:

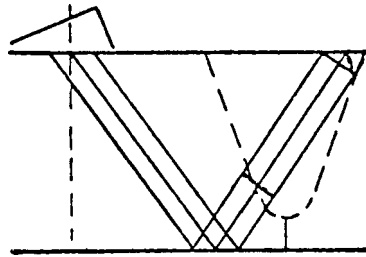

FIG. 15 Cracks

6.1.1 *Instrumentation*—The ultrasonic instrument shall be capable of generating, receiving, amplifying, and displaying high-frequency electrical pulses.

6.1.2 *Search Units*—The ultrasonic search units shall be capable of transmitting and receiving ultrasonic waves in the material at frequencies and energy levels necessary for discontinuity detection as determined by the standardization procedure. The search units are fitted with wedges in order to transmit ultrasonic waves into the examination object at the desired angle and mode of operation.

6.1.3 *Couplant*—A couplant, usually a liquid or semiliquid, is required between the face of the search unit and the examination surface to permit the transmission of ultrasonic waves from the search unit into the material under examination. Typical couplants include glycerin, water, cellulose gel, oil, water-soluble oils, and grease. Corrosion inhibitors or wetting agents or both may be used. Couplants must be selected that are not detrimental to the product or the process. The couplant used in standardization should be used for the examination. The standardization and examination surface temperatures should be within $\pm 25^{\circ}\text{F}$ [$\pm 14^{\circ}\text{C}$] (14°C) to avoid large attenuation and velocity differences in the wedge material.

6.1.3.1 The coupling medium should be selected so that its viscosity is appropriate for the surface finish of the material to be examined. The examination of rough surfaces generally requires a high-viscosity couplant. The temperature of the material's surface can change the couplant's viscosity. As an example, in the case of oil and greases, see Table 1.

6.1.3.2 At elevated temperatures (above 125°F [52°C]), (52°C), heat-resistant coupling materials such as silicone oils, gels, or greases should be used. Further, intermittent contact of the search unit with the surface or auxiliary cooling of the search unit may be necessary to avoid temperature changes that affect the ultrasonic wave transmission properties of the wedge material or the characteristics of the transducer. At higher temperatures, certain couplants based on inorganic salts or thermoplastic organic materials, high-temperature wedge materials, and transducers that are not damaged by high temperatures, may be required.

6.1.3.3 Where constant coupling over large areas is needed, as in automated examination, or where severe changes in surface roughness are found, other couplings such as liquid-gap coupling will usually provide a better examination. In this case, the search unit face does not contact the examination surface but is spaced from it a distance of about 0.02 in. (0.5 mm) by integral rails or a fixture. Liquid flowing through the search unit fills the gap. The flowing liquid provides the coupling path and has the additional advantage of keeping the search unit temperature low if the examination surface is hot.

6.1.3.4 An alternative means of direct contact coupling is provided by the wheel search unit. The transducer is mounted at the required angle to a stationary axle about which rotates a liquid-filled flexible tire. A minimum amount of couplant provides ultrasonic transmission into the examination surface since the elastic tire material is in rolling contact and conforms closely to the surface.

6.1.4 *Reference Reflectors*—Reference reflectors of known dimension, artificial reflectors, or distance-amplitude relationships of known reflector sizes for a particular search unit and material may be used for standardization. The artificial reflectors may be in the form of side-drilled holes, notches, or flat-bottom holes. The reference standard and the production material should have similar velocity, attenuation, curvature, and surface finish.

7. Standardization

7.1 If quantitative information is to be obtained, vertical or horizontal linearity or both should be checked in accordance with Practice E317 or another procedure approved by the examining agency and the customer. An acceptable linearity performance may

TABLE 1 Suggested Viscosities—Oil Couplants

NOTE 1—The table is a guide only and is not meant to exclude the use of a particular couplant that is found to work satisfactorily on a particular surface.

Approximate Surface Roughness Average (Ra $\mu\text{in.}$)	Equivalent Couplant Viscosity, weight motor oil
5 to 100	SAE 10
50 to 200	SAE 20
100 to 400	SAE 30
250 to 700	SAE 40
Over 1000	cup grease