



Designation: E1823 – 10a

## Standard Terminology Relating to Fatigue and Fracture Testing<sup>1</sup>

This standard is issued under the fixed designation E1823; the number immediately following the designation indicates the year of original adoption or, in the case of revision, the year of last revision. A number in parentheses indicates the year of last reapproval. A superscript epsilon ( $\epsilon$ ) indicates an editorial change since the last revision or reapproval.

### 1. Scope

1.1 This terminology contains definitions, definitions of terms specific to certain standards, symbols, and abbreviations approved for use in standards on fatigue and fracture testing. The definitions are preceded by two lists. The first is an alphabetical listing of symbols used. (Greek symbols are listed in accordance with their spelling in English.) The second is an alphabetical listing of relevant abbreviations.

1.2 This terminology includes **Annex A1** on Units and **Annex A2** on Designation Codes for Specimen Configuration, Applied Loading, and Crack or Notch Orientation.

### 2. Referenced Documents

#### 2.1 ASTM Standards:<sup>2</sup>

- E6 Terminology Relating to Methods of Mechanical Testing
- E23 Test Methods for Notched Bar Impact Testing of Metallic Materials
- E28 Test Methods for Softening Point of Resins Derived from Naval Stores by Ring-and-Ball Apparatus
- E208 Test Method for Conducting Drop-Weight Test to Determine Nil-Ductility Transition Temperature of Ferritic Steels
- E338 Test Method of Sharp-Notch Tension Testing of High-Strength Sheet Materials
- E399 Test Method for Linear-Elastic Plane-Strain Fracture Toughness  $K_{Ic}$  of Metallic Materials
- E436 Test Method for Drop-Weight Tear Tests of Ferritic Steels
- E467 Practice for Verification of Constant Amplitude Dynamic Forces in an Axial Fatigue Testing System
- E468 Practice for Presentation of Constant Amplitude Fatigue Test Results for Metallic Materials
- E561 Test Method for  $K-R$  Curve Determination
- E602 Test Method for Sharp-Notch Tension Testing with Cylindrical Specimens

- E604 Test Method for Dynamic Tear Testing of Metallic Materials
- E606 Practice for Strain-Controlled Fatigue Testing
- E647 Test Method for Measurement of Fatigue Crack Growth Rates
- E739 Practice for Statistical Analysis of Linear or Linearized Stress-Life ( $S-N$ ) and Strain-Life ( $\epsilon-N$ ) Fatigue Data
- E740 Practice for Fracture Testing with Surface-Crack Tension Specimens
- E813 Test Method for  $J_{Ic}$ , A Measure of Fracture Toughness
- E992 Practice for Determination of Fracture Toughness of Steels Using Equivalent Energy Methodology
- E1049 Practices for Cycle Counting in Fatigue Analysis
- E1152 Test Method for Determining J-R-Curves
- E1221 Test Method for Determining Plane-Strain Crack-Arrest Fracture Toughness,  $K_{Ia}$ , of Ferritic Steels
- E1290 Test Method for Crack-Tip Opening Displacement (CTOD) Fracture Toughness Measurement
- E1291 Test Method for Test Method for Conducting a Saturated Vapor Inhalation Study with Rats<sup>3</sup>
- E1304 Test Method for Plane-Strain (Chevron-Notch) Fracture Toughness of Metallic Materials
- E1457 Test Method for Measurement of Creep Crack Growth Times in Metals
- E1681 Test Method for Determining Threshold Stress Intensity Factor for Environment-Assisted Cracking of Metallic Materials
- E1737 Test Method for J-Integral Characterization of Fracture Toughness (Discontinued 1998)<sup>3</sup>
- E1820 Test Method for Measurement of Fracture Toughness
- E1921 Test Method for Determination of Reference Temperature,  $T_o$ , for Ferritic Steels in the Transition Range
- E1942 Guide for Evaluating Data Acquisition Systems Used in Cyclic Fatigue and Fracture Mechanics Testing
- E2208 Guide for Evaluating Non-Contacting Optical Strain Measurement Systems
- E2443 Guide for Verifying Computer-Generated Test Results Through The Use Of Standard Data Sets
- E2472 Test Method for Determination of Resistance to Stable Crack Extension under Low-Constraint Conditions

<sup>1</sup> This terminology is under the jurisdiction of ASTM Committee E08 on Fatigue and Fracture and is the direct responsibility of Subcommittee E08.02 on Standards and Terminology.

Current edition approved June 1, 2010. Published July 2010. Originally approved in 1996. Last previous edition approved in 2010 as E1823 – 10. DOI: 10.1520/E1823-10A.

<sup>2</sup> For referenced ASTM standards, visit the ASTM website, www.astm.org, or contact ASTM Customer Service at service@astm.org. For *Annual Book of ASTM Standards* volume information, refer to the standard's Document Summary page on the ASTM website.

<sup>3</sup> Withdrawn. The last approved version of this historical standard is referenced on www.astm.org.

G15 Terminology Relating to Corrosion and Corrosion Testing<sup>3</sup>

3. Terminology

3.1 Alphabetical Listing of Principal Symbols Used in This Terminology:

Symbol	Term
$a$	crack depth, crack length, crack size, estimated crack size
$a_e$	effective crack size
$a_n$	notch length
$a_o$	original crack size
$a_p$	physical crack size
$a/W$	normalized crack size
$A$	force ratio ( $P_a/P_m$ )
$A_N$	net-section area
$b$	remaining ligament
$b_o$	original uncracked ligament
$B$	specimen thickness
$B_e$	effective thickness
$B_N$	net thickness
$2c$	surface-crack length
$C$	normalized $K$ -gradient
$D$	cycle ratio ( $n/N_i$ )
$C^*(t)$	$C^*(t)$ – Integral
$da/dN$	fatigue-crack-growth rate
$\delta$	crack-tip opening displacement (CTOD)
$\delta d$	specimen gage length
$\Delta a$	crack extension, estimated crack extension
$\Delta K$	stress-intensity-factor range
$\Delta K_{th}$	fatigue-crack-growth threshold
$\Delta P$	force range
$\epsilon_a$	strain amplitude
$\epsilon_{in}$	inelastic strain
$\epsilon_m$	mean force
$G$	crack-extension force
$G_R$	crack-extension resistance
$H^*$	specimen center of pin hole distance
$\Gamma$	the path of the $J$ -integral
$J$	$J$ -integral
$J_{Ic}$	plane-strain fracture toughness
$J_R$	crack-extension resistance
$k_f$	fatigue notch factor
$k_t$	theoretical stress concentration factor (sometimes abbreviated stress concentration factor)
$K, K_1, K_2, K_3, K_I, K_{II}, K_{III}$	stress-intensity factor (see mode)
$K_a$	crack-arrest fracture toughness
$K_c$	plane-stress fracture toughness
$K_{EAC}$	stress intensity factor threshold for environment-assisted cracking
$K_{Ia}$	plane-strain crack-arrest fracture toughness
$K_{IEAC}$	stress intensity factor threshold for plane strain environment-assisted cracking
$K_{Ic}$	plane-strain fracture toughness
$K_{IVM}, K_{Iv}, K_{Ivj}$	plane-strain (chevron-notch) fracture toughness
$K_{max}$	maximum stress-intensity factor
$K_{min}$	minimum stress-intensity factor
$K_o$	stress-intensity factor at crack initiation
$K_R$	crack-extension resistance
$n$	cycles endured
$N_f$	fatigue life
$P$	force
$P_a$	force amplitude
$P_m$	mean force
$P_M$	precrack force
$P_{max}$	maximum force
$P_{min}$	minimum force
$q$	fatigue notch sensitivity
$r$	effective unloading slope ratio
$r_c$	critical slope ratio
$r_y$	plastic-zone adjustment
$\bar{R}$	force ratio ( $P_{min}/P_{max}$ )
$s$	sample standard deviation
$s^2$	sample variance

Symbol	Term
$S$	specimen span
$S_a$	force amplitude
$S_f$	fatigue limit
$S_m$	mean force
$S_N$	fatigue strength at $N$ cycles
$\sigma_c$	crack strength
$\sigma_N$	nominal (net-section) stress
$\sigma_r$	residual strength
$\sigma_s$	sharp-notch strength
$\sigma_{TS}$	tensile strength
$\sigma_x, \sigma_y, \sigma_z$	normal stresses (refer to )
$\sigma_Y$	effective yield strength
$\sigma_{YS}$	yield strength
$T$	specimen temperature
$t_T$	transition time
$\tau_t$	total cycle period
$\tau_{xy}, \tau_{yz}, \tau_{zx}$	shear stresses (refer to Fig. 1)
$u$	displacement in $x$ direction
$v$	displacement in $y$ direction
$2V_m$	crack-mouth opening displacement
$V_c$	force-line displacement due to creep
$w$	displacement in $z$ direction
$W$	specimen width
$Y^*$	stress-intensity factor coefficient
$Y_m^*$	minimum stress-intensity factor coefficient

3.2 Alphabetical Listing of Abbreviations Used:

$CMOD$	crack-mouth opening displacement
$COD$	see CTOD
$CTOD$	crack-tip opening displacement
$DT$	dynamic tear
$DWTT$	drop-weight tear test
$EAC$	environment-assisted cracking
$K-EE$	equivalent-energy fracture toughness
$NTS$	notch tensile strength
$PS$	part-through surface
$SCC$	stress corrosion cracking
$SZW$	stretch zone width

3.3 Definitions—Each definition is followed by the designation(s) of the standard(s) of origin. The listing of definitions is alphabetical.

**alternating force**—See **loading amplitude**.

**applied-K curve**—a curve (a fixed-force or fixed-displacement crack-extension-force curve) obtained from a fracture mechanics analysis for a specific configuration. The curve relates the stress-intensity factor to crack size and either applied force or displacement.

DISCUSSION—The resulting analytical expression is sometimes called a  $K$  calibration and is frequently available in handbooks for stress-intensity factors. **E647**

**basic data**—the sampled value of a sensor taken at fixed or variable time intervals. Each sample represents the value measured by the sensor at that instant of time.

DISCUSSION—in Test Method **E2208**, for optical, non-contacting methods, a two dimensional array of image intensity data is generally the basic data. **E1942, E2208, E2443**

**block**—in *fatigue loading*, a specified number of constant amplitude loading cycles applied consecutively, or a spectrum loading sequence of finite length that is repeated identically. **E1823**

**blunting line**—in *fracture testing*, a line that approximates apparent crack advance due to crack-tip blunting in the absence of slow stable crack tearing. The line is defined based on the assumption that the crack advance is equal to

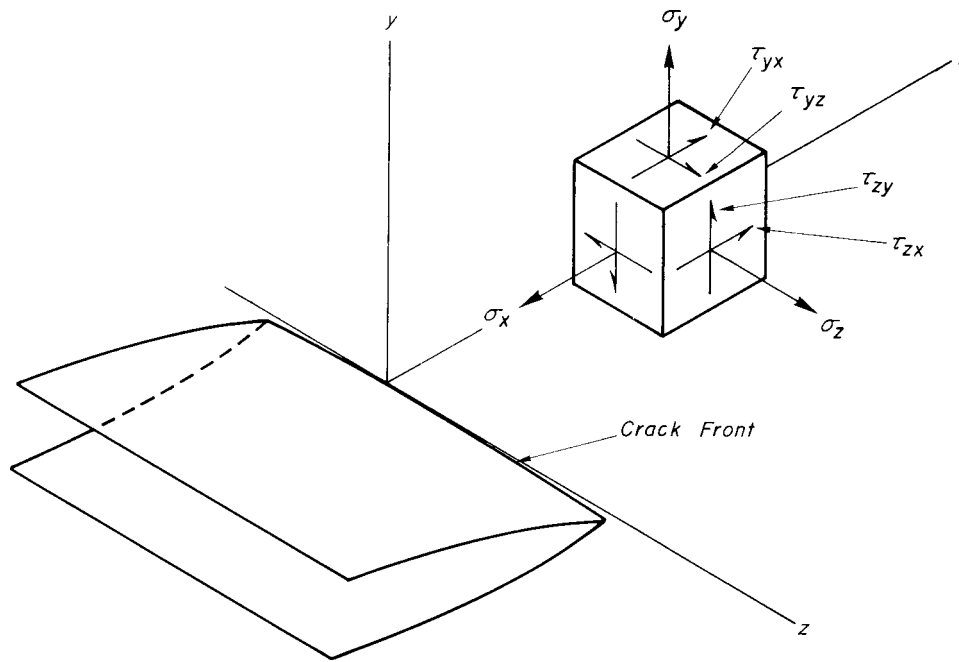

NOTE—See definition of mode.

FIG. 1 Customary Coordinate System and Stress on a Small Volume Element Located on the x Axis Just Ahead of the Crack Front

one half of the crack-tip opening displacement. This estimate of pseudo-crack advance,  $\Delta a_B$ , is based on the effective yield strength of the material tested. **E813**

$$\Delta a_B = J/2 \sigma_y \quad (1)$$

**circulation rate** [ $L^3 T^{-1}$ ]*—in fatigue testing*, the volume rate of change of the environment chamber volume. **E1823**

**clipping***—in fatigue spectrum loading*, the process of decreasing or increasing the magnitude of all loads (strains) that are, respectively, above or below a specified level, referred to as clipping level; the loads (strains) are decreased or increased to the clipping level (see Fig. 2). **E1823**

**compliance** [ $LF^{-1}$ ],  $n$ —the ratio of displacement increment to force increment. **E1820**

**confidence interval***—an interval estimate of a population parameter computed so that the statement "the population parameter included in this interval" will be true, on the average, in a stated proportion of the times such computations are made based on different samples from the population.* **E1823**

**confidence level (or coefficient)***—the stated proportion of the times the confidence interval is expected to include the population parameter.* **E1823**

**confidence limits***—the two statistics that define a confidence interval.* **E1823**

**control force, Pm [F]***—a calculated value of maximum force used in Test Method E1820 to stipulate allowable precracking limits.* **E1820, E1921**

**constant amplitude loading***— in fatigue loading*, a loading (straining) in which all of the peak forces (strains) are equal and all of the valley forces (strains) are equal. **E1049**

**constant life diagram***— in fatigue*, a plot (usually on rectangular coordinates) of a family of curves each of which is for a single fatigue life,  $N$ , relating stress amplitude,  $S_a$ , to mean

stress,  $S_m$ , or maximum stress,  $S_{max}$ , or both, to minimum stress,  $S_{min}$ . The constant life fatigue diagram is usually derived from a family of  $S-N$  curves each of which represents a different stress ratio ( $A$  or  $R$ ) for a 50 % probability of survival. **E1820**

**control force, Pm [F]***—a calculated value of maximum force used in Test Method E1820 to stipulate allowable precracking limits.* source **E1820, E1921**

**corrosion fatigue***—the process by which fracture occurs prematurely under conditions of simultaneous corrosion and repeated cyclic loading at lower stress levels or fewer cycles than would be required in the absence of the corrosive environment.* **G15**

**counting method***—in fatigue spectrum loading*, a method of counting the occurrences and defining the magnitude of various loading parameters from a load-time history; (some of the counting methods are: level crossing count, peak count, mean crossing peak count, range count, range-pair count, rain-flow count, racetrack count). **E1049**

**crack displacement [L]***—the force-induced separation vector between two points (on the facing surfaces of a crack) that were initially coincident.*

DISCUSSION—In Practice E561, displacement is the distance that a chosen measurement point on the specimen displaces normal to the crack plane. Measurement points on the C(W) and C(T) specimen configurations are identified as locations V0, V1, and V2. **E561**

**crack extension,  $\Delta a$  [L]***—an increase in crack size.*

DISCUSSION—For example, in Practice E561,  $\Delta a_p$  or  $\Delta a_e$  is the difference between the crack size, either  $a_p$  (physical crack size) or  $a_e$  (effective crack size), and  $a_o$  (original crack size). **E561**

**crack-extension force, G [ $FL^{-1}$  or  $FLL^{-2}$ ]***—the elastic energy per unit of new separation area that is made available at*

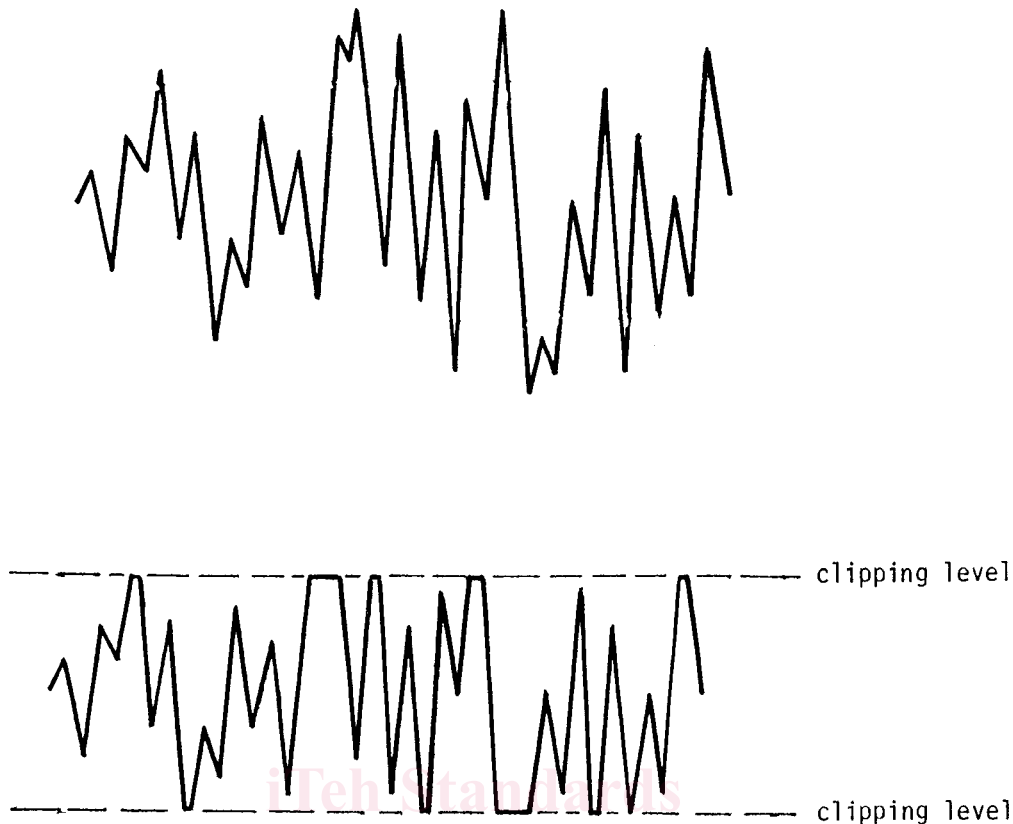

FIG. 2 Clipping of Fatigue Spectrum Loading

the front of an ideal crack in an elastic solid during a virtual increment of forward crack extension.

DISCUSSION—This force concept implies an analytical model for which the stress-strain relations are regarded as elastic. The preceding definition of  $G$  applies to either static cracks or running cracks. From past usage,  $G$  is commonly associated with linear-elastic methods of analysis, although the  $J$  (see **J-integral**) also may be used for such analyses.

E1823

**crack-extension resistance,  $K_R$  [ $FL^{-3/2}$ ],  $G_R$  [ $FL^{-1}$ ] or  $J_R$  [ $FL^{-1}$ ]**—a measure of the resistance of a material to crack extension expressed in terms of the stress-intensity factor,  $K$ ; crack-extension force,  $G$ ; or values of  $J$  derived using the  $J$ -integral concept.

DISCUSSION—See definition of  $R$ -curve.

E561

**crack initiation**—the onset of crack propagation from a preexisting macroscopic crack created in the specimen by a stipulated procedure.

E1921

**crack-mouth opening displacement (CMOD),  $2v_m$  [L]**—the Mode 1 (also called opening-mode) component of crack displacement resulting from the total deformation (elastic plus plastic), measured under force at the location on a crack surface that has the greatest elastic displacement per unit force.

DISCUSSION—In part-through surface-crack (PS) specimens,  $CMOD$  is measured on the specimen surface at the midpoint of the crack length.

E740

**crack-plane orientation**—an identification of the plane and

direction of fracture or crack extension in relation to product configuration. This identification is designated by a hyphenated code with the first letter(s) representing the direction normal to the crack plane and the second letter(s) designating the expected direction of crack propagation.

DISCUSSION—See also E1823 Annex A2, (A2.4 on crack or notch orientation).

E399, E1457

**crack size,  $a$  [L]**—principal lineal dimension used in the calculation of fracture mechanics parameters for through-thickness cracks as defined in the applicable standard. See Fig. A2.2 for schematic representations.

DISCUSSION—For example, in the C(T) specimen  $a$  is the average measurement from the line connecting the bearing points of force application; in the M(T) specimen,  $a$  is the average measurement from the perpendicular bisector of the central crack.

DISCUSSION—In practice, the value of  $a$  is obtained from procedures for measurement of physical crack size,  $a_p$ , original crack size,  $a_o$ , and effective crack size,  $a_e$ , as appropriate to the situation being considered.

DISCUSSION—For part-through cracks see crack depth ( $a$ ) and surface crack length ( $2c$ ) in *Definitions of Terms* (Specific to the indicated standards.)

DISCUSSION—In Test Method E1457, the physical crack size is represented as  $a_p$ . The subscript  $p$  is everywhere implied.

E1457

**crack strength,  $\sigma_c$  [ $FL^{-2}$ ]**—the maximum value of the nominal stress that a cracked structure is capable of sustaining.

DISCUSSION—1 Crack strength is calculated on the basis of the maximum force and the original minimum cross-sectional area (net cross section or ligament). Thus, it takes into account the original size

of the crack but ignores any crack extension that may occur during the test.

DISCUSSION—2 Crack strength is analogous to the ultimate tensile strength, as it is based on the ratio of the maximum force to the minimum cross-sectional area at the start of the test. **E338, E602**

**crack-tip opening displacement (CTOD),  $\delta$ , [L]**—the crack displacement resulting from the total deformation (elastic plus plastic) at variously defined locations near the original (prior to force application) crack tip.

DISCUSSION—In common practice,  $\delta$  is estimated for Mode I by inference from observations of crack displacement nearby or away, or both, from the crack tip. **E1290**

**crack-tip plane strain**—a stress-strain field (near the crack tip) that approaches plane strain to the degree required by an empirical criterion.

DISCUSSION—For example, in Mode I, the criterion for crack-tip plane strain given by Test Method **E399** requires that plate thickness,  $B$ , must be equal to or greater than  $2.5 (K/\sigma_{YS})^2$ . **E399**

**crack-tip plane stress**—a stress-strain field (near the crack tip) that is not in plane strain.

DISCUSSION—In such situations, a significant degree of plane strain may be present. **E1823**

**creep crack growth (CCG) rate,  $da/dt$  or  $\Delta a/\Delta t$  [L/t]**—the rate of crack extension caused by creep damage and expressed in terms of average crack extension per unit time. **E1457**

**criterion of failure**—complete separation, or the presence of a crack of specified length visible at a specified magnification. Other criteria may be used but should be clearly defined. **E468**

**crystallographic cleavage**—the separation of a crystal along a plane of fixed orientation relative to the three-dimensional crystal structure within which the separation process occurs, with the separation process causing the newly formed surfaces to move away from one another in directions containing major components of motion perpendicular to the fixed plane. **E1823**

*cumulative frequency spectrum*—See **exceedances spectrum**.

*cumulative occurrences spectrum*—See **exceedances spectrum**.

**cycle**—*in fatigue*, one complete sequence of values of force (strain) that is repeated under constant amplitude loading (straining). (See Fig. 3.) The symbol  $N$  (see definition of **fatigue life**) is used to indicate the number of cycles.

DISCUSSION—In *spectrum loading*, definition of cycle varies with the counting method. **E1823**

**cycle ratio,  $D$** —the ratio of cycles endured,  $n$ , to the estimated fatigue life,  $N_f$ , obtained from the stress versus fatigue life ( $S-N$ ) or the strain versus fatigue life ( $\epsilon-N$ ) diagram for cycles of the same character, that is,  $D = n/N_f$ . **E1823**

**cycles endured,  $n$** —*in fatigue*, the number of cycles of specified character (that produce fluctuating force) which a specimen has endured at any time in its force history. **E1823**

*cyclic loading*—See **fatigue loading**.

**deaeration**—*in environmentally affected fatigue testing*, the process of removal of air from the liquid environment before and during a test. **E1823**

**derived data**—data obtained through processing of the basic data. Typically, this is displacement field data. **E1942, E2208, E2443**

**dynamometer**—an elastic calibration device used to verify the indicated forces applied by a fatigue testing system. It shall consist of an instrumented member having mass, stiffness, and end displacements such that the inertial effects of the specimen and its attachments to the testing machine for which the verification of forces is desired are duplicated within 5 %. The instrumentation shall permit an accurate determination of the magnitude of the average strain in a region of the uniform transverse cross section when the dynamometer is subjected to a tensile or compressive force along its longitudinal axis, within 1 % of the true strains. A strain gaged specimen is often used as a dynamometer. **E467**

**dynamometer dynamic forces [F]**—the maximum and minimum forces (or the mean force and the force amplitude) that correspond to the readings obtained from the dynamometer output according to an existing static calibration. Such forces are considered true specimen dynamic forces for the purpose of this terminology. **E467**

**dynamometer range [F]**—the range of forces for which the dynamometer may be used for verification purposes. A dynamometer for use in tension and in compression will have two dynamometer ranges, one in tension and one in compression. **E467**

**effective crack size,  $a_e$  [L]**—the physical crack size augmented to account for crack-tip plastic deformation.

DISCUSSION—Sometimes the effective crack size,  $a_e$ , is calculated from a measured value of a physical crack size,  $a_p$ , plus a calculated value of a plastic-zone adjustment,  $r_Y$ . Another method for calculation of  $a_e$  involves comparing the compliance from the secant of a force-deflection trace with the elastic compliance from a calibration for the given specimen design. **E561**

**effective modulus,  $E_{\text{eff}}$  [FL<sup>-2</sup>]**—an elastic modulus that can be used with experimentally determined elastic compliance to effect an exact match to theoretical (modulus-normalized) compliance for the actual initial crack size,  $a_0$ . **E561, E1291, E1921**

DISCUSSION—for Test Method **E1291**, effective modulus,  $E_{\text{eff}}$  [FL<sup>-2</sup>] is an elastic modulus that can be used with experimentally determined elastic compliance to effect an exact match to theoretical (modulus-normalized) compliance for the actual initial crack size,  $a_0$ .

**effective thickness  $B_e$  [L]**—for compliance-based extension measurements: **E1823, E1820**

$$B_e = B - (B - B_N)^2/B \quad (2)$$

DISCUSSION—for Test Method **E1820**, for side-grooved specimens  $Be = B - (B - B_N)^2/B$ . This is used for elastic unloading compliance measurement of crack size.

**effective yield strength,  $\sigma_Y$  [FL<sup>-2</sup>]**—an assumed value of uniaxial yield strength, that represents the influences of plastic yielding upon fracture test parameters. **E1820, E1921**

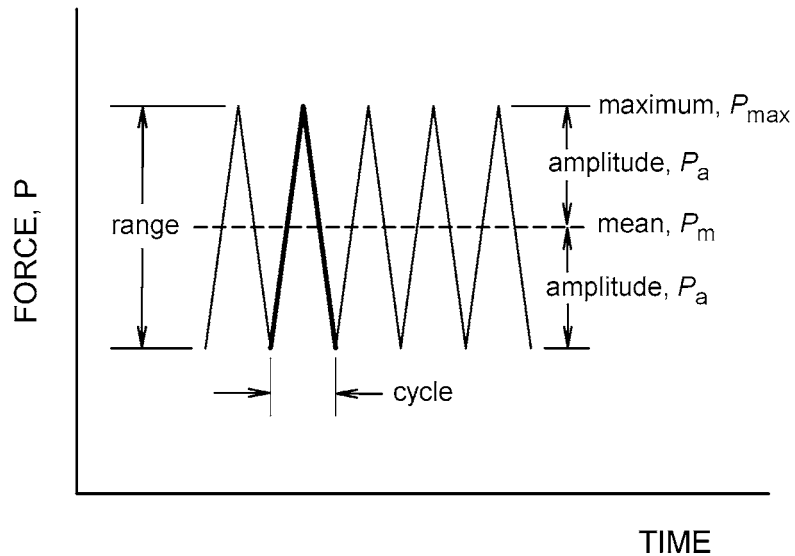

(a) Constant Amplitude Loading

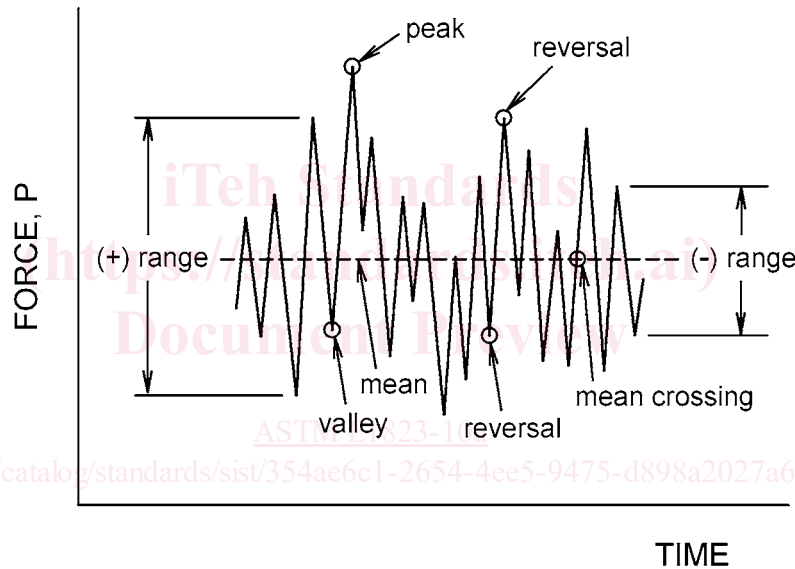

(b) Spectrum Loading

FIG. 3 Fatigue Loading Basic Terms

DISCUSSION—1 It is calculated as the average of the 0.2 % offset yield strength,  $\sigma_{YS}$ , and the ultimate tensile strength,  $\sigma_{TS}$ , as follows:

$$\sigma_Y = (\sigma_{YS} + \sigma_{TS})/2 \quad (3)$$

DISCUSSION—2 In estimating  $\sigma_Y$ , influences of testing conditions, such as loading rate and temperature, should be considered.

**elastic constraint modulus, E' [FL-2]**—a linear-elastic factor relating stress to strain, the value of which is dependent on the degree of constraint. For plane stress,  $E' = E$  is used, and for plane strain,  $E/(1 - \nu^2)$  is used, with  $\nu$  being Poisson's ratio. **E399, E647, E1457, E1681, E1921,**

*elastic modulus*—see **modulus of elasticity.**

**environment**—*in fatigue testing*, the aggregate of chemical species and energy that surrounds a test specimen. **E1823**

**environment chamber**—*in fatigue testing*, the container of the bulk volume surrounding a test specimen. **E1823**

**environment chamber volume [L<sup>3</sup>]**—*in fatigue testing*, that

bulk volume surrounding a test specimen. **E1823**

**environment composition [ML<sup>-3</sup>]**—*in corrosion fatigue testing*, the concentration of the chemical components in the fluid environment surrounding a test specimen. **E1823**

**environment hydrogen content [ML<sup>-3</sup>]**—*in corrosion fatigue testing*, the hydrogen gas concentration of the fluid environment surrounding a test specimen. **E1823**

**environment monitoring**—*in fatigue testing*, the periodic or continuous measurement of fluid concentrations of the environment. **E1823**

**environment oxygen content [ML<sup>-3</sup>]**—*in corrosion fatigue testing*, the oxygen concentration of the fluid environment surrounding a test specimen. **E1823**

**environment pressure [FL<sup>-2</sup>]**—*in fatigue testing*, the pressure of the bulk volume surrounding a test specimen. **E1823**

**environment temperature**— *in fatigue testing*, the temperature of the bulk volume surrounding a test specimen.

**E1823**

**environment volume** [ $L^3$ ]—*in fatigue testing*, the total volume immediately surrounding a test specimen plus that contained in a circulating reservoir if applicable.

**E1823**

**estimate**—*in statistical analysis*, the particular value or values of a parameter computed by an estimation procedure for a given sample.

**E1823**

**estimated crack extension,  $\Delta a$**  [ $L$ ]—an increase in estimated crack size ( $\Delta a = a - a_{og}$ ).

**E1737**

**estimated crack size  $a$**  [ $L$ ]—the distance from a reference plane to the observed crack front developed from measurements of elastic compliance or other methods. The reference plane depends on the specimen form, and it is normally taken to be either the boundary, or a plane containing either the force line or the centerline of a specimen or plate. The reference plane is defined prior to specimen deformation.

**E1737**

**estimation**—*in statistical analysis*, a procedure for making a statistical inference about the numerical values of one or more unknown population parameters from the observed values in a sample.

**E1823**

**exceedances spectrum**— *in fatigue loading*, representation of spectrum loading contents by the number of times specified values of a particular loading parameter (peak, range, and so forth) are equaled or exceeded (also known as *cumulative occurrences* or *cumulative frequency spectrum*).

**E1823**

**fatigue**—the process of progressive localized permanent structural change occurring in a material subjected to conditions that produce fluctuating stresses and strains at some point or points and that may culminate in cracks or complete fracture after a sufficient number of fluctuations.

DISCUSSION—1 In ceramic technology, static tests of considerable duration are called “static fatigue” tests, a type of test referred to as stress-rupture in metal testing.

DISCUSSION—2 Fluctuations may occur both in force and with time (frequency) as in the case of “random vibration.”

**E1823**

**fatigue-crack-growth rate (FCGR),  $da/dN$** , [ $L/cycle$ ]—the rate of crack extension under fatigue loading, expressed in terms of crack extension per cycle of fatigue.

**E1823**

**fatigue-crack-growth threshold,  $\Delta K_{th}$**  [ $FL^{-3/2}$ ]—that asymptotic value of  $\Delta K$  at which  $da/dN$  approaches zero. For most materials an *operational*, though arbitrary, definition of  $\Delta K_{th}$  is given as that  $\Delta K$  which corresponds to a fatigue crack growth rate of  $10^{-10}$  m/cycle.

DISCUSSION—The intent of this Definition is not to define a true threshold, but rather to provide a practical means of characterizing a material’s fatigue crack growth resistance in the near-threshold regime.

Caution is required in extending this concept to design.

**E647**

*fatigue cycle*—See **cycle**.

**fatigue life,  $N_f$** —the number of cycles of a specified character that a given specimen sustains before failure of a specified nature occurs. Fatigue life, or the logarithm of fatigue life, is a dependent variable.

**E1823**

**fatigue life for  $p$  % survival**—an estimate of the fatigue life that  $p$  % of the population would attain or exceed under a

given loading. The observed value of the median fatigue life estimates the fatigue life for 50 % survival. Fatigue life for  $p$  % survival values, where  $p$  is any number, such as, 95, 90, and so forth, also may be estimated from the individual fatigue life values.

**E1823**

**fatigue limit,  $S_f$**  [ $FL^{-2}$ ]—the limiting value of the median fatigue strength as the fatigue life,  $N_f$ , becomes very large.

DISCUSSION—Certain materials and environments preclude the attainment of a fatigue limit. Values tabulated as “fatigue limits” in the literature are frequently (but not always) values of  $S_N$  for which 50 % of the specimens survive a predetermined number of cycles. These specimens are frequently tested at a mean stress of zero.

**E1823**

**fatigue limit for  $p$  % survival** [ $FL^{-2}$ ]—the limiting value of fatigue strength for  $p$  % survival as  $N$  becomes very large;  $p$  may be any number, such as 95, 90, and so forth.

**E1823**

**fatigue loading**—periodic, or not periodic, fluctuating loading applied to a test specimen or experienced by a structure in service. (Also known as *cyclic loading*.)

**E1823**

**fatigue notch factor,  $k_f$** —the ratio of the fatigue strength of a specimen with no stress concentration to a specimen with a stress concentration for the same percent survival at  $N$  cycles and for the same conditions.

DISCUSSION—1 In specifying  $k_f$ , it is necessary to specify the geometry and the values of  $S_a$ ,  $S_m$ , and  $N$  for which it is computed.

DISCUSSION—2  $k_f$  was originally termed the fatigue limit (endurance limit) reduction factor. Early data pertained almost exclusively to mild steels, namely, to  $S_a - N$  curves with knees. Later the term was generalized to fatigue strength reduction factor; but, nevertheless, the  $k_f$  values tabulated in the literature still pertain almost exclusively to very long (“infinite”) fatigue lives where the notched and unnotched  $S_a - N$  curves were almost parallel and almost horizontal. Otherwise, the  $k_f$  data are not consistent and are markedly dependent on the type of notch, the fatigue life of interest, and the value of the mean stress.

DISCUSSION—3 Virtually no  $k_f$  data exist for percentiles other than (approximately) 50 %. Nevertheless,  $k_f$  is highly dependent on the percentile of interest.

**E1823**

**fatigue notch sensitivity,  $q$** —a measure of the degree of agreement between fatigue notch factor,  $k_f$ , and theoretical stress concentration factor,  $k_t$ .

DISCUSSION—1 The definition of fatigue notch sensitivity is  $q = (k_f - 1)/(k_t - 1)$ .

DISCUSSION—2  $q$  was originally termed the fatigue notch sensitivity index.

DISCUSSION—3 Virtually all  $q$  data and  $q$  curves found in the literature pertain to very long (“infinite”) fatigue lives where the notched and unnotched  $S_a - N$  curves are almost parallel and almost horizontal, as well as to tests in which  $S_m = 0$ . Thus, these values should not be extrapolated to  $S_m \neq 0$  or “finite” life situations.

DISCUSSION—4 Fatigue notch sensitivity is not considered to be a material property.

**E1823**

**fatigue strength at  $N$  cycles,  $S_N$**  [ $FL^{-2}$ ]—a value of stress for failure at exactly  $N$  cycles as determined from an  $S - N$  diagram. The value of  $S_N$  thus determined is subject to the same conditions as those which apply to the  $S - N$  diagram.

DISCUSSION—The value of  $S_N$  that is commonly found in the literature is the value of  $S_{max}$  or  $S_a$  at which 50 % of the specimens of a given sample could survive  $N$  stress cycles in which  $S_m = 0$ . This is also known as the median fatigue strength for  $N$  cycles.

**E1823**

**fatigue strength for  $p$  % survival at  $N$  cycles [FL<sup>-2</sup>]**—an estimate of the stress level at which  $p$  % of the population would survive  $N$  cycles;  $p$  may be any percent, such as 95, 90, and so forth.

DISCUSSION—ASTM STP 588<sup>4</sup> and STP 744<sup>5</sup> include estimation methods for these values. **E1823**

**fatigue testing system**—a device for applying repeated force cycles to a specimen or component. **E467**

**ferritic steels**—typically carbon, low-alloy, and higher alloy grades. Typical microstructures are bainite, tempered bainite, tempered martensite, and ferrite and pearlite. All ferritic steels have body centered cubic crystal structures that display ductile-to-cleavage transition temperature fracture toughness characteristics. See also test methods **E23**, **E208**, and **E436**. **E1921**

DISCUSSION—This definition is not intended to imply that all of the many possible types of ferritic steels have been verified as being amenable to analysis by Test Method **E1921**.

**force,  $P$  [F]**—the force applied to a test specimen or to a component.

DISCUSSION—used in Practices **E1049** to denote force, stress, strain, torque, acceleration, or other parameters of interest. **E1823**

*force cycle*—See **cycle**.

**force line displacement rate  $d\Delta_{LL}/dt$  [LT<sup>-1</sup>]**—rate of increase of specimen force-line displacement. **E1921**

**force range,  $\Delta P$  [F]**—*in fatigue loading*, the algebraic difference between successive valley and peak forces (positive range or increasing force range) or between successive peak and valley forces (negative range or decreasing force range). (See **Fig. 3**.) In constant amplitude loading, the range is given as follows:

$$\Delta P = P_{\max} - P_{\min} \quad (4)$$

DISCUSSION—In cycle counting by various methods, it is common to employ ranges between valley and peak forces, or between peak and valley forces, which are not necessarily successive events. The word “range” is used in this broader sense when dealing with cycle counting. **E1823**

**force ratio (also stress ratio),  $R$ ,  $A$** —*in fatigue*, the algebraic ratio of the two loading parameters of a cycle. The most widely used ratios are as follows

$$R = \frac{\text{minimum load}}{\text{maximum load}} = \frac{P_{\min}}{P_{\max}} = \frac{S_{\min}}{S_{\max}}, \text{ and} \quad (5)$$

$$A = \frac{\text{loading amplitude}}{\text{mean load}} = \frac{P_a}{P_m} = \frac{S_a}{S_m} \quad (6)$$

**force (strain) amplitude,  $P_a$  ( $S_a$  or  $\epsilon_a$ ) [F or FL<sup>-2</sup>]**—*in fatigue loading*, one half of the range of a cycle (see **Fig. 3**) (also known as *alternating force*). **E1823**

**force transducer**—a device which indicates the applied force by means of an electrical voltage. Usually the electrical voltage increases linearly with applied force. **E467**

**fracture toughness**—a generic term for measures of resistance to extension of a crack.

DISCUSSION—The term is sometimes restricted to results of fracture mechanics tests, which are directly applicable in fracture control. However, the term commonly includes results from tests of notched or precracked specimens which do not involve fracture mechanics analysis. Results from tests of the latter type are often useful for fracture control, based upon either service experience or empirical correlations with tests analyzed using fracture mechanics. **E740**

**frequency distribution**—the way in which the frequencies of occurrence of members of a population, or a sample, are distributed in accordance with the values of the variable under consideration. **E1823**

**group**—*in fatigue*, specimens of the same type tested at a specific time, or consecutively, at one stress level. A group may comprise one or more specimens. **E1823**

**high point, High**—the point on a force-displacement plot, at the start of an unloading-reloading cycle, at which the displacement reverses direction, that is, the point at which the specimen mouth begins closing due to unloading (see points labeled High in **Fig. 4** and **Fig. 5**). **E1304**

**hold time,  $t_h$  [T]**—*in fatigue testing*, the amount of time in the cycle where the controlled test variable (for example, force, strain, displacement) remains constant with time. (See **Fig. 6**.) **E606**

**hysteresis diagram**—*in fatigue*, the stress-strain path during a cycle. **E1823**

**ideal crack**—a simplified model of a crack. In a stress-free body, the crack has two smooth surfaces that are coincident and join within the body along a smooth curve called the crack front; in two-dimensional representations the crack front is called the crack tip. **E1823**

**ideal-crack-tip stress field**—the singular stress field, infinitesimally close to the crack front, that results from loading an ideal crack. In a linear-elastic homogeneous body, the significant stress components vary inversely as the square root of the distance from the crack tip.

DISCUSSION—In a linear-elastic body, the crack-tip stress field can be regarded as the superposition of three component stress fields called modes. **E1823**

**independent variable**—the selected and controlled variable (namely, stress or strain). It is denoted  $X$  when plotted on appropriate coordinates. **E739**

**indicated dynamic forces [F]**—the maximum and minimum forces (or the mean force and the force amplitude) that correspond to the readings obtained from the force transducer associated with the fatigue testing system, according to an existing static calibration. The force transducer calibration may have been furnished by the machine manufacturer or may have been developed by the user. **E467**

**inelastic strain,  $\epsilon_{in}$** —the strain that is not elastic.

DISCUSSION—For isothermal conditions,  $\epsilon_{in}$  is calculated by subtracting the elastic strain from the total strain. **E606**

**interval estimate**—the estimate of a parameter given by two statistics, defining the end points of an interval. **E1823**

<sup>4</sup> *Manual on Statistical Planning and Analysis*, ASTM STP 588, ASTM, 1975.

<sup>5</sup> *Statistical Analysis of Fatigue Data*, ASTM STP744, ASTM, 1979.



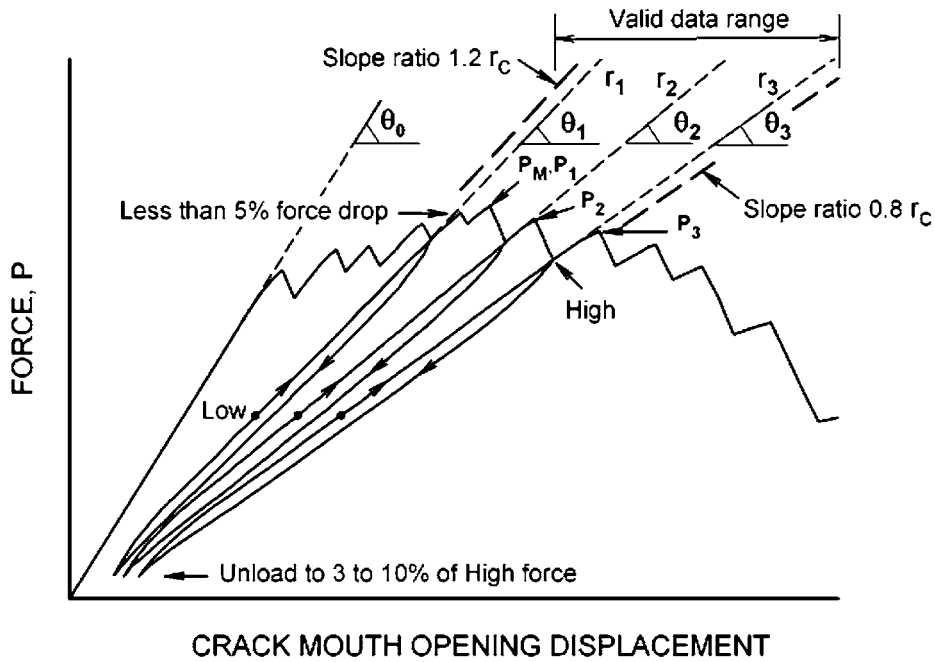

FIG. 4 Schematic of a Force-Displacement Test Record for Crack Jump Behavior, with Unloading/Reloading Cycles, Data Reduction Constructions, and Definitions of Terms

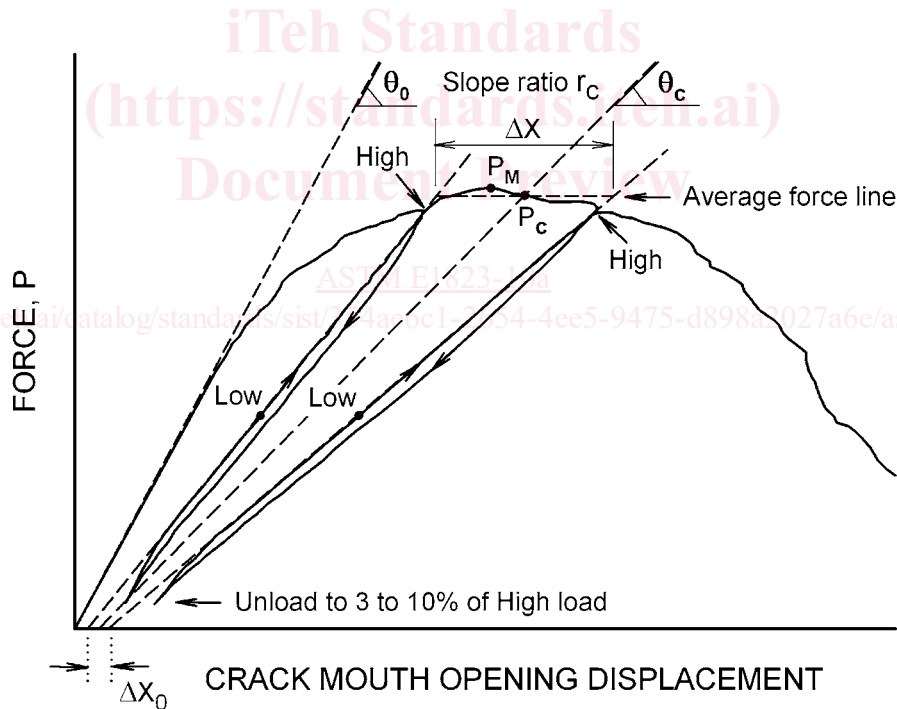
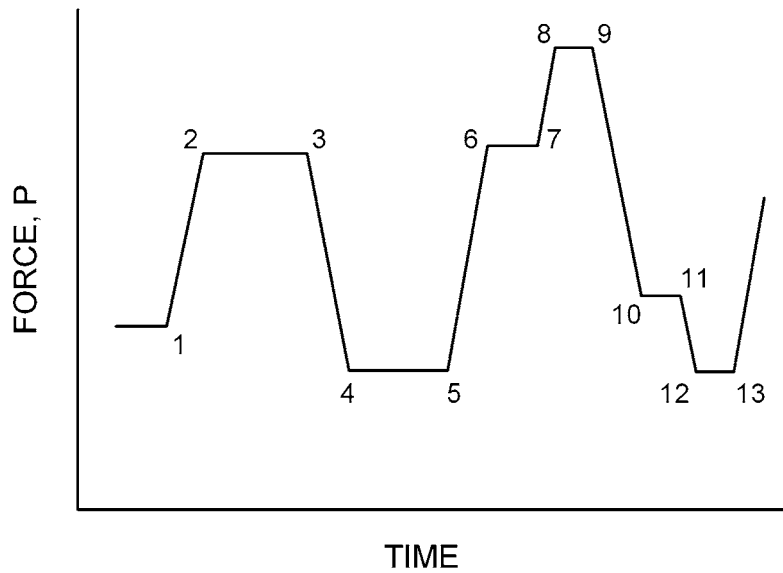

FIG. 5 Schematic of a Force-Displacement Test Record for Smooth Crack Growth Behavior, with Unloading/Reloading Cycles, Data Reduction Constructions, and Definitions of Terms

**irregularity factor**— in *fatigue loading*, the ratio of the number of zero crossings with positive slope (or mean crossings) to the number of peaks or valleys in a given, force-time history.

*irregular loading*— See **spectrum loading**.

**J-integral,  $J$  [ $FL^{-1}$ ]**—a mathematical expression, a line or surface integral that encloses the crack front from one crack



Example of Definitions  
 Hold Times: 2-3, 4-5, 6-7, 8-9, 10-11, 12-13  
 Peaks: 2-3, 8-9  
 Valleys: 4-5, 12-13  
 Reversals: 3, 5, 9, 13

FIG. 6 Definitions of Terms for Force-Histories with Hold Times

surface to the other, used to characterize the local stress-strain field around the crack front. **E1457, E1820**

DISCUSSION—1 The *J*-integral expression for a two-dimensional crack, in the *x*-*z* plane with the crack front parallel to the *z* axis, is the line integral,

$$J = \int_{\Gamma} \left( W dy - T \frac{\partial u}{\partial x} ds \right) \quad (7)$$

where:

- W* = loading work per unit volume or, for elastic bodies, strain energy density,
- $\Gamma$  = path of the integral, that encloses (that is, contains) the crack tip (see Fig. 7),
- ds* = increment of the contour path,
- T* = outward traction vector on *ds*,
- u* = displacement vector at *ds*,
- x, y, z* = rectangular coordinates (see Fig. 1), and
- $T \frac{\partial u}{\partial x} ds$  = rate of work input from the stress field into the area enclosed by  $\Gamma$ .

DISCUSSION—2 The value of *J* obtained from the preceding equation is taken to be path independent for commonly used specimen designs. However, in service components (and perhaps in test specimens), caution is needed to adequately consider loading interior to  $\Gamma$  such as from motion of the crack and from residual and thermal stress.

DISCUSSION—3 In elastic (linear or nonlinear) solids, the *J*-integral equals the crack-extension force, *G*. (See **crack extension force**.)

DISCUSSION—4 In Test Method **E1820**, in elastic (linear and nonlinear) solids for which the mathematical expression is path independent, the *J*-integral is equal to the value obtained from two identical bodies with infinitesimally differing crack areas each subject to stress. The parameter *J* is the difference in work per unit difference in crack area

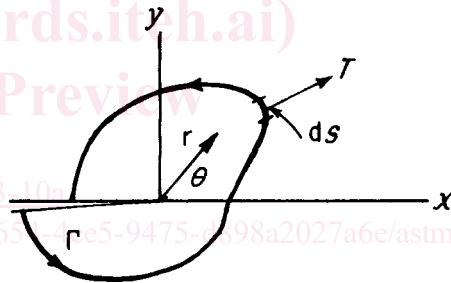

FIG. 7 *J*-Integral Contour and Symbolism

at a fixed value of displacement or, where appropriate, at a fixed value of force.<sup>6</sup>

***J*-R curve**—a plot of far-field *J*-integral versus the physical crack extension,  $\Delta a_p$ . It is recognized that the far-field value of *J* may not represent the stress-strain field local to a growing crack. **E1820**

DISCUSSION—In Test Method **E1820**, the *J*-R curve is a plot of the *J*-integral against physical crack extension  $\Delta a_p$ .

***K*-R-curve**—a plot of crack-extension resistance as a function of stable crack extension,  $\Delta a_p$  or  $\Delta a_e$ .

DISCUSSION—For specimens discussed in Practice **E561**, the influence of in-plane geometry appears to be negligible, but *K*-R-curves normally depend upon specimen thickness and, for some materials, upon temperature and strain rate. **E561, E1820**

<sup>6</sup> For further discussion, see Rice, J. R., *Journal of Applied Mechanics*, Vol 35, 1968, p. 379.