



SLOVENSKI STANDARD

SIST ISO 2553:1995

01-november-1995

Varjeni, trdo in mehko lotani spoji - Simbolično prikazovanje na risbah

Welded, brazed and soldered joints -- Symbolic representation on drawings

Joints soudés et brasés -- Représentations symboliques sur les dessins

Ta slovenski standard je istoveten z: ISO 2553:1992

[SIST ISO 2553:1995](https://standards.iteh.ai/catalog/standards/sist/67cd21aa-c2d9-491d-8e17-e3e1aa2ceca2/sist-iso-2553-1995)

<https://standards.iteh.ai/catalog/standards/sist/67cd21aa-c2d9-491d-8e17-e3e1aa2ceca2/sist-iso-2553-1995>

ICS:

01.100.20	Konstrukcijske risbe	Mechanical engineering drawings
25.160.40	Varjeni spoji in vari	Welded joints

SIST ISO 2553:1995

en

iTeh STANDARD PREVIEW
(standards.iteh.ai)

SIST ISO 2553:1995

<https://standards.iteh.ai/catalog/standards/sist/67cd21aa-c2d9-491d-8e17-e3e1aa2ceca2/sist-iso-2553-1995>

INTERNATIONAL STANDARD

ISO
2553

Third edition
1992-10-01

Welded, brazed and soldered joints — Symbolic representation on drawings

Jointes soudées et brasées — Représentations symboliques sur les dessins
iTeh STANDARD PREVIEW
(standards.iteh.ai)

[SIST ISO 2553:1995](#)

<https://standards.iteh.ai/catalog/standards/sist/67cd21aa-c2d9-491d-8e17-e3e1aa2ceca2/sist-iso-2553-1995>



Reference number
ISO 2553:1992(E)

Contents

	Page
1 Scope	1
2 Normative references	1
3 General	1
4 Symbols	2
4.1 Elementary symbols	2
4.2 Combinations of elementary symbols	5
4.3 Supplementary symbols	6
5 Position of the symbols on drawings	8
5.1 General	8
5.2 Relationship between the arrow line and the joint	8
5.3 Position of the arrow line	10
5.4 Position of the reference line	10
5.5 Position of the symbol with regard to the reference line	11
6 Dimensioning of welds	12
6.1 General rules	12
6.2 Main dimensions to be shown	12
7 Complementary indications	18
7.1 Peripheral welds	18
7.2 Field or site welds	18
7.3 Indication of the welding process	18
7.4 Sequence of information in the tail of the reference mark	18
8 Examples for application of spot and seam joints	19

© ISO 1992

All rights reserved. No part of this publication may be reproduced or utilized in any form or by any means, electronic or mechanical, including photocopying and microfilm, without permission in writing from the publisher.

International Organization for Standardization
Case Postale 56 • CH-1211 Genève 20 • Switzerland

Printed in Switzerland

Annexes

A	Examples of use of symbols	22
B	Guidance for converting drawings made in accordance with ISO 2553:1974 into the new system in accordance with ISO 2553:1991	50

iTeh STANDARD PREVIEW
(standards.iteh.ai)

[SIST ISO 2553:1995](https://standards.iteh.ai/catalog/standards/sist/67cd21aa-c2d9-491d-8e17-e3e1aa2ceca2/sist-iso-2553-1995)

<https://standards.iteh.ai/catalog/standards/sist/67cd21aa-c2d9-491d-8e17-e3e1aa2ceca2/sist-iso-2553-1995>

Foreword

ISO (the International Organization for Standardization) is a worldwide federation of national standards bodies (ISO member bodies). The work of preparing International Standards is normally carried out through ISO technical committees. Each member body interested in a subject for which a technical committee has been established has the right to be represented on that committee. International organizations, governmental and non-governmental, in liaison with ISO, also take part in the work. ISO collaborates closely with the International Electrotechnical Commission (IEC) on all matters of electrotechnical standardization.

Draft International Standards adopted by the technical committees are circulated to the member bodies for voting. Publication as an International Standard requires approval by at least 75 % of the member bodies casting a vote.

International Standard ISO 2553 was prepared by Technical Committee ISO/TC 44, *Welding and allied processes*, Sub-Committee SC 7, *Representation and terms*.

This third edition cancels and replaces the second edition (ISO 2553:1984), which has been technically revised to include ISO 2553/DAD 1:1987.

Annexes A and B of this International Standard are for information only.

iTeh STANDARD PREVIEW
(standards.iteh.ai)

<https://standards.iteh.ai/catalog/standards/sist/07cd21aa-c2d9-491d-8e17-e3e1aa2ceca2/sist-iso-2553-1995>

Welded, brazed and soldered joints — Symbolic representation on drawings

1 Scope

This International Standard prescribes the rules to be applied for the symbolic representation of welded, brazed and soldered joints on drawings.

2 Normative references

The following standards contain provisions which, through reference in this text, constitute provisions of this International Standard. At the time of publication, the editions indicated were valid. All standards are subject to revision, and parties to agreements based on this International Standard are encouraged to investigate the possibility of applying the most recent editions of the standards indicated below. Members of IEC and ISO maintain registers of currently valid International Standards.

ISO 128:1982, *Technical drawings — General principles of presentation*.

ISO 544:1989, *Filler materials for manual welding — Size requirements*.

ISO 1302:1978, *Technical drawings — Method of indicating surface texture on drawings*.

ISO 2560:1973, *Covered electrodes for manual arc welding of mild steel and low alloy steel — Code of symbols for identification*.

ISO 3098-1:1974, *Technical drawings — Lettering — Part 1: Currently used characters*.

ISO 3581:1976, *Covered electrodes for manual arc welding of stainless and other similar high alloy steels — Code of symbols for identification*.

ISO 4063:1990, *Welding, brazing, soldering and braze welding of metals — Nomenclature of processes and*

reference numbers for symbolic representation on drawings.

ISO 5817:1992, *Arc-welded joints in steel — Guidance on quality levels for imperfections*.

ISO 6947:1990, *Welds — Working positions — Definitions of angles of slope and rotation*.

ISO 8167:1989, *Projections for resistance welding*.

ISO 10042:—¹⁾, *Arc-welded joints in aluminium and its weldable alloys — Guidance on quality levels for imperfections*.

3 General

3.1 Joints may be indicated with the general recommendations for technical drawings. However, for the purpose of simplification, it is advisable to adopt, for usual joints, the symbolic representation described in this International Standard.

3.2 The symbolic representation shall give clearly all necessary indications regarding the specific joint to be obtained without over-burdening the drawing with notes or showing an additional view.

3.3 This symbolic representation includes an elementary symbol which may be completed by

- a supplementary symbol;
- a means of showing dimensions;
- some complementary indications (particularly for workshop drawings).

3.4 In order to simplify the drawings as much as possible it is recommended that references be made to specific instructions or particular specifications giving all details of the preparation of edges to be

1) To be published.

welded, brazed and soldered and/or welding, brazing and soldering procedures, rather than showing these indications on the drawings of the welded parts.

If there are no such instructions, the dimensions relating to the preparation of the edges to be welded, brazed and soldered and/or welding, brazing and soldering procedures can be close to the symbol.

4 Symbols

4.1 Elementary symbols

The various categories of joints are characterized by a symbol which, in general, is similar to the shape of the weld to be made.

The symbol shall not be taken to prejudge the process to be employed.

The elementary symbols are shown in table 1.

If the joint should not be specified but only be represented that the joint will be welded, brazed or soldered, the following symbol shall be used:

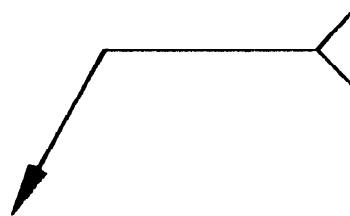

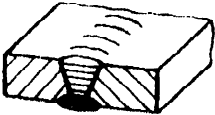

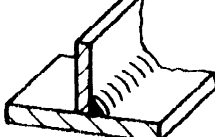



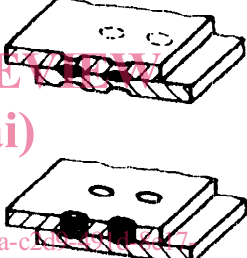

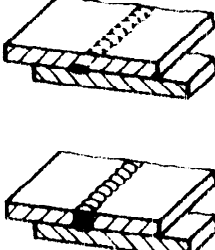





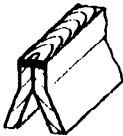

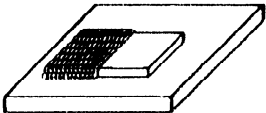

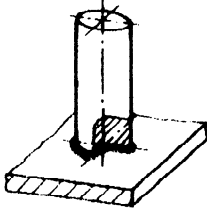







Table 1 — Elementary symbols

No.	Designation	Illustration	Symbol
1	Butt weld between plates with raised edges ¹⁾ ; edge flanged weld /USA/ (the raised edges being melted down completely)		
2	Square butt weld		
3	Single-V butt weld		
4	Single-bevel butt weld		
5	Single-V butt weld with broad root face		
6	Single-bevel butt weld with broad root face		
7	Single-U butt weld (parallel or sloping sides)		

No.	Designation	Illustration	Symbol
8	Single-J butt weld		
9	Backing run; back or backing weld /USA/		
10	Fillet weld		
11	Plug weld; plug or slot weld /USA/		
12	Spot weld	<p data-bbox="477 1000 1127 1113" style="text-align: center;">iTeh STANDARD PREVIEW (standards.iteh.ai)</p> <p data-bbox="444 1147 1159 1238" style="text-align: center;"><small>SIST ISO 2553:1995 https://standards.iteh.ai/catalog/standards/sist/67cd21aa-c2d8-4777-7e3e1aa2ceca2/sist-iso-2553-1995</small></p> 	
13	Seam weld		
14	Steep-flanked single-V butt weld		
15	Steep-flanked single-bevel butt weld		

No.	Designation	Illustration	Symbol
16	Edge weld		
17	Surfacing		
18	Surface joint		
			
19	Inclined joint		
20	Fold joint		

iTeh STANDARD PREVIEW
(standards.iteh.ai)

SIST ISO 2553:1995
<https://standards.iteh.ai/catalog/standards/sist/67cd27aa-c2d9-491d-8e17-e3e1aa2ceca2/sist-iso-2553-1995>

1) Butt welds between plates with raised edges (symbol 1) not completely penetrated are symbolized as square butt welds (symbol 2) with the weld thickness s shown (see table 5)

4.2 Combinations of elementary symbols









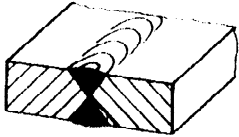

When required, combinations of elementary symbols can be used.

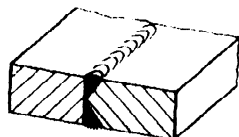
The elementary symbols are to be combined for welding from both sides in such a manner arranging the applicable elementary symbols symmetrical to the reference line. Typical examples are given in

table 2 and applications for symbolic representation in table A.2.

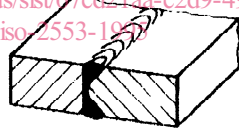
NOTE 1 Table 2 gives a collection of combinations of elementary symbols for symmetrical welds. For the symbolic representation the elementary symbols are arranged symmetrically at the reference line (see table A.2). For the use of symbols out of symbolic representation the symbols may be represented without the reference line.

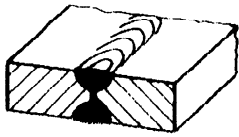
Table 2 — Combined symbols for symmetrical welds (examples)

Designation	Illustration	Symbol
Double-V butt weld (X weld)		
Double-bevel butt weld		
Double-V butt weld with broad root face		
Double-bevel butt weld with broad root face		
Double-U butt weld		

4.3 Supplementary symbols

Elementary symbols may be completed by a symbol characterizing the shape of the external surface or the shape of the weld.





The recommended supplementary symbols are given in table 3.

The absence of a supplementary symbol means that the shape of the weld surface does not need to be indicated precisely.

Examples of combinations of elementary and supplementary symbols are given in tables 4 and A.3.

NOTE 2 Although it is not forbidden to associate several symbols, it is better to represent the weld on a separate sketch when symbolization becomes too difficult.

Table 3 — Supplementary symbols

Shape of weld surface or weld	Symbol
a) Flat (usually finished flush)	—
b) Convex	
c) Concave	
d) Toes shall be blended smoothly	
e) Permanent backing strip used	
f) Removable backing strip used	











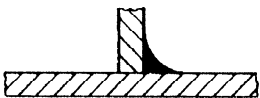

iTeh STANDARD PREVIEW (standards.iteh.ai)

[SIST ISO 2553:1995](https://standards.iteh.ai/catalog/standards/sist/67cd21aa-c2d9-491d-8e17-e3e1aa2ceca2/sist-iso-2553-1995)

<https://standards.iteh.ai/catalog/standards/sist/67cd21aa-c2d9-491d-8e17-e3e1aa2ceca2/sist-iso-2553-1995>

Table 4 gives examples of application of the supplementary symbols.

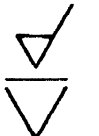
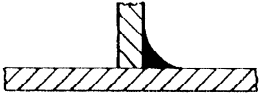
Table 4 — Examples of application of supplementary symbols

Designation	Illustration	Symbol
Flat (flush) single-V butt weld		
Convex double-V weld		
Concave fillet weld		
Flat (flush) single-V butt weld with flat (flush) backing run		
Single-V butt weld with broad root face and backing run		
Flush finished single-V butt weld		
Fillet weld with smooth blended face		

¹⁾ Symbol in accordance with ISO 1302; instead of this symbol the main symbol $\sqrt{\quad}$ can be used.

5 Position of the symbols on drawings

5.1 General

The symbols covered by these rules form only part of the complete method of representation (figure 1), which comprises in addition to the symbol (3) itself:

- an arrow line (1) per joint (see figure 2 and figure 3);
- a dual reference line, consisting of two parallel lines, one continuous and one dashed (2) (exception, see note 3);
- a certain number of dimensions and conventional signs.

NOTES

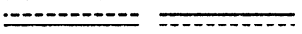
3 The dashed line can be drawn either above or beneath the continuous line  (see also 5.5 and annex B).

For symmetrical welds, the dashed line is unnecessary and should be omitted.

4 The thickness of lines for arrow line, reference line, symbol and lettering shall be in accordance with the thickness of line for dimensioning in accordance with ISO 128 and ISO 3098-1, respectively.

The purpose of the following rules is to define the location of welds by specifying

- the position of the arrow line;
- the position of the reference line;
- the position of the symbol.

The arrow line and the reference line form the complete reference mark. If details are given, e.g. for processes, acceptance levels, position, filler and auxiliary materials (see clause 7), a tail shall be added at the end of the reference line.

5.2 Relationship between the arrow line and the joint

The examples given in figure 2 and figure 3 explain the meaning of the terms

- "Arrow side" of the joint;
- "Other side" of the joint.

NOTE 5 The position of the arrow in these figures is chosen for purposes of clarity. Normally, it would be placed immediately adjacent to the joint.

NOTE 6 See figure 2.

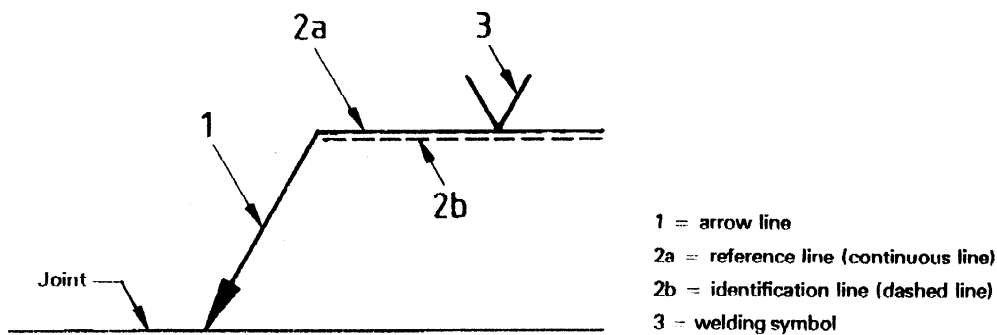

Figure 1 — Method of representation

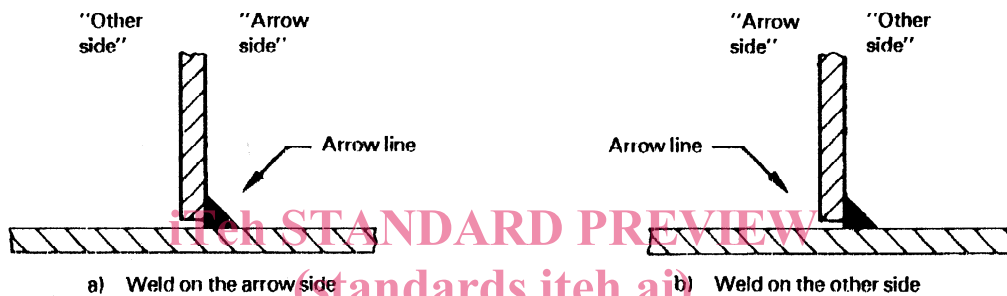

Figure 2 — T joint with one fillet weld

SIST ISO 2553:1995

<https://standards.iteh.ai/catalog/standards/sist/67cd21aa-c2d9-491d-8e17-e3e1aa2ceca2/sist-iso-2553-1995>

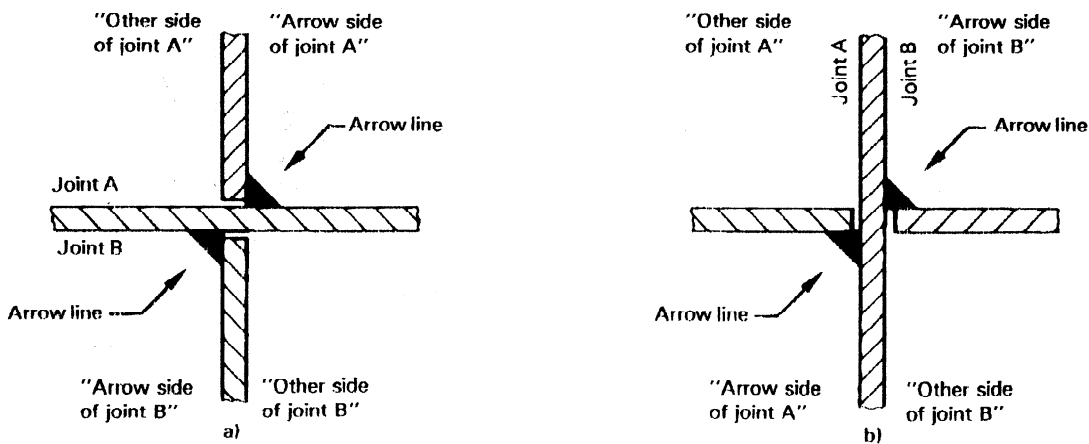

Figure 3 — Cruciform joint with two fillet welds