



Designation: D3983 – 98 (Reapproved 2011)

# Standard Test Method for Measuring Strength and Shear Modulus of Nonrigid Adhesives by the Thick-Adherend Tensile-Lap Specimen<sup>1</sup>

This standard is issued under the fixed designation D3983; the number immediately following the designation indicates the year of original adoption or, in the case of revision, the year of last revision. A number in parentheses indicates the year of last reapproval. A superscript epsilon ( $\epsilon$ ) indicates an editorial change since the last revision or reapproval.

## 1. Scope

1.1 This test method describes a method of measuring the shear modulus and rupture stress in shear of adhesives in bonded joints. The method employs lap-shear specimens with wood, metal, or composite adherends, with adhesives having shear moduli ranging up to 700 MPa (100 000 psi). This test method is suitable generally for joints in which the ratio of adherend tensile modulus to adhesive shear modulus is greater than 300 to 1. It is not suitable for adhesives that have a high shear modulus in the cured state and that also require elimination of volatile constituents during cure.

1.2 The values stated in SI units are to be regarded as standard. The values given in parentheses are for information only.

1.3 *This standard does not purport to address all of the safety concerns, if any, associated with its use. It is the responsibility of the user of this standard to establish appropriate safety and health practices and determine the applicability of regulatory limitations prior to use.*

## 2. Referenced Documents

- 2.1 *ASTM Standards:*<sup>2</sup>
- D143 Test Methods for Small Clear Specimens of Timber
  - D905 Test Method for Strength Properties of Adhesive Bonds in Shear by Compression Loading
  - D907 Terminology of Adhesives
  - D1151 Practice for Effect of Moisture and Temperature on Adhesive Bonds
  - D2651 Guide for Preparation of Metal Surfaces for Adhesive Bonding
  - E6 Terminology Relating to Methods of Mechanical Testing
  - E83 Practice for Verification and Classification of Extensometer Systems

<sup>1</sup> This test method is under the jurisdiction of ASTM Committee D14 on Adhesives and is the direct responsibility of Subcommittee D14.70 on Construction Adhesives.

Current edition approved Jan. 1, 2011. Published January 2011. Originally approved in 1981. Last previous edition approved in 2004 as D3983 – 98 (2004). DOI: 10.1520/D3983-98R11.

<sup>2</sup> For referenced ASTM standards, visit the ASTM website, www.astm.org, or contact ASTM Customer Service at service@astm.org. For *Annual Book of ASTM Standards* volume information, refer to the standard's Document Summary page on the ASTM website.

- E104 Practice for Maintaining Constant Relative Humidity by Means of Aqueous Solutions
- E229 Test Method for Shear Strength and Shear Modulus of Structural Adhesives (Withdrawn 2003)<sup>3</sup>

## 3. Terminology

### 3.1 Definitions:

3.1.1 For definitions of terms used in this test method, refer to Terminologies E6 and D907.

3.1.2 *initial tangent modulus, n*—the slope of the stress-strain curve at the origin.

3.1.3 *nominal stress, n*—the stress at a point calculated on the net cross section by simple elastic theory without taking into account the effect on the stress produced by discontinuities such as holes, grooves, fillets, etc.

3.1.4 *normal stress, n*—the stress component perpendicular to a plane on which the forces act, that is, the plane of the bondline.

3.1.5 *proportional limit, n*—the maximum stress that a material is capable of sustaining without significant deviation from proportionality of stress to strain.

3.1.6 *secant modulus, n*—the slope of the secant drawn from the origin to any specified point on the stress-strain curve.

3.1.6.1 *Discussion*—Modulus is expressed in force per unit area (MPa, lb/in.<sup>2</sup>, etc.).

3.1.7 *shear modulus, n*—the ratio of shear stress to corresponding shear strain below the proportional limit. (Compare *secant modulus*.)

3.1.7.1 *Discussion*—The term shear modulus is generally reserved for materials that exhibit linear elastic behavior over most of their stress-strain diagram. Many adhesives exhibit curvilinear or nonelastic behavior, or both, in which case some other term, such as secant modulus, may be substituted.

3.1.8 *shear strain, n*—the tangent of the angular change, due to force, between two lines originally perpendicular to each other through a point in the body.

3.1.8.1 *Discussion*—Shear strain equals adherend slip/adhesive layer thickness.

<sup>3</sup> The last approved version of this historical standard is referenced on www.astm.org.

3.1.9 *shear strength, n*—in an adhesive joint, the maximum average stress when a force is applied parallel to the joint.

3.1.9.1 *Discussion*—In most adhesive test methods, the shear strength is actually the maximum average stress at failure of the specimen, not necessarily the true maximum stress in the material.

3.1.10 *shear stress, n*—the stress component tangential to the plane of which the forces act, that is, the plane of the bondline.

3.1.10.1 *Discussion*—Nominal shear stress equals load/bond area.

3.1.11 *strain, n*—the unit change due to force, in the size or shape of a body referred to its original size or shape.

3.1.12 *stress, n*—the intensity at a point in a body of the internal forces or components of force that act on a given plane through the point.

3.1.13 *stress-strain diagram, n*—a diagram in which corresponding values of stress and strain are plotted against each other. Values of stress are usually plotted as ordinates (vertically) and values of strain as abscissas (horizontally).

3.2 *Definitions of Terms Specific to This Standard:*

3.2.1 *load, n*—the force applied to the specimen at any given time.

3.2.2 *load-slip diagram, n*—a diagram in which corresponding values of load and slip are plotted against each other. Values of load are usually plotted as ordinates (vertically) and values of slip as abscissas (horizontally).

3.2.2.1 *Discussion*—Stress-strain behavior is commonly recorded in the form of a load-slip diagram. The difference between the two is simply one of scale. Load is divided by bond area to obtain stress and slip is divided by adhesive layer thickness to obtain strain. Examples of various types of load-slip diagrams and modulus are shown in Figs. 1-3.

3.2.3 *rate of strain, n*—rate of slip per unit adhesive thickness.

3.2.4 *slip, n*—the relative collinear displacement of the adherends on either side of the adhesive layer in the direction of the applied load.

3.3 *Symbols:*

- 3.3.1  $c$  = half the overlap length =  $L/2$ , mm or in.
- 3.3.2  $\hat{G}$  = estimate of shear modulus of adhesive, MPa or psi.
- 3.3.3  $G$  = shear modulus of adhesive, MPa or psi.
- 3.3.4  $E$  = tensile modulus of adherend, MPa or psi.
- 3.3.5  $t$  = thickness of adherend, mm or in.
- 3.3.6  $\eta$  = thickness of adhesive, mm or in.
- 3.3.7  $P_{max}$  = failure load for the bond, N or lbf.
- 3.3.8  $L$  = overlap length, mm or in.
- 3.3.9  $A$  = bond area, mm<sup>2</sup> or in.<sup>2</sup>.
- 3.3.10  $\delta$  = adherend slip at load equivalent to 0.1  $P_{max}$ , mm or in.
- 3.3.11  $\bar{\tau}_{max}$  = maximum nominal shear stress sustained by the bond, MPa or psi.

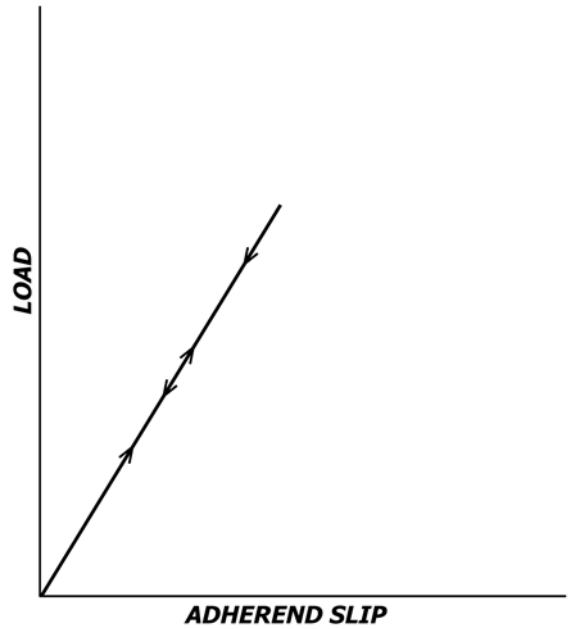

NOTE 1—Case load and unload diagrams and modulus line are congruent.

FIG. 1 Load-Slip Diagram of Linear Elastic Adhesive Under Cyclic Low-Level Loading

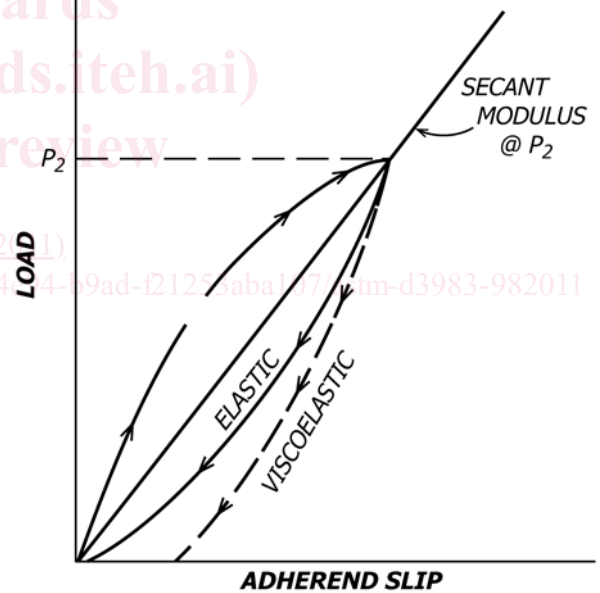

NOTE 1—The modulus is represented by the secant modulus line at some load  $P_2$  less than the load to cause failure.

FIG. 2 Load-Slip Diagram of Nonlinear Adhesive Under Cyclic Low-Level Loading Showing Both Elastic and Viscoelastic Recovering Diagrams

4. Summary of Test Method

4.1 Lap-shear specimens are prepared with the adhesive in question using selected adherends. The load-deformation properties of the specimens are measured under specific recommended conditions to yield a “first estimate” of adhesive shear modulus. This estimate is used to determine the optimized joint geometry for best attainable uniformity of stress distribution in

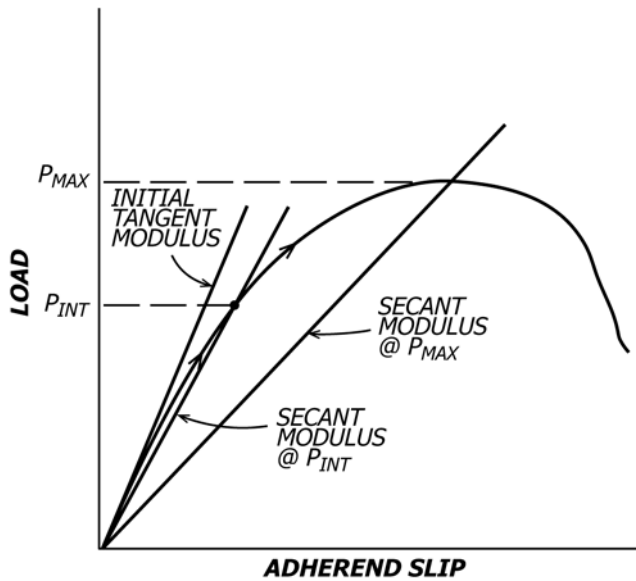

NOTE 1—The modulus may be represented by the initial tangent, the secant drawn to the ultimate load, or the secant drawn to some intermediate load.

FIG. 3 Load-Slip Diagram of Adhesive Loaded to Failure

the joint. A second set of specimens is prepared having the optimized joint geometry. The final values for load-deformation properties are then measured under a variety of controlled environmental and experimental conditions.

4.2 The test method is based upon the theoretical analysis by Goland and Reissner<sup>4</sup> relating stress concentrations (that is, nonuniformity) in single-lap joints to the geometry of the joint and the mechanical properties of the materials involved. The controlling factor in the Goland and Reissner equations is a composite of essentially three ratios which can be manipulated to improve the stress uniformity in the joint, and thereby control the accuracy of measurement. Stress uniformity is improved by (1) increasing the adherend tensile modulus in relation to the shear modulus of the adhesive, and by (2) increasing adherend and adhesive thickness while minimizing overlap length. Because of these relationships, the practice was developed to use high-modulus adherends in thick cross sections.

## 5. Significance and Use

5.1 This test method is capable of providing shear modulus and shear strength values for adhesives with accuracy suitable for use by design engineers in predicting the characteristics of building assemblies bonded with nonrigid adhesives. Adhesive formulators will also find the method useful during the development of new adhesive systems. In general, the thick adherend lap-shear test is a useful tool in research during studies of both short- and long-term load-deformation properties of adhesives. This thick adherend lap-shear test yields a uniformity of stress distribution approaching that obtained in

thin tubular butt joints subjected to torsion, which is considered to be a condition of pure shear.

5.2 The user is cautioned that pure shear strength cannot be obtained by this test method, because some tensile and compression stresses and stress concentrations are present in the joint. The estimate of shear strength by this test method will be conservative. If pure shear strength is demanded, then Test Method E229 should be used.

## 6. Equipment

6.1 *Test Machine*—A tension test machine with electronic load cell capacities of 0 to 100 and 0 to 1000 kg (0 to 200 and 0 to 2000 lb) is satisfactory for this test method. The machine should have a loading rate capability of 0 to 200 kg/min (0 to 400 lb/min) or a crosshead movement rate of 0 to 1 mm/min (0 to 0.040 in./min). Closed-loop control of load level and loading rate, or crosshead position and movement rate, is desirable to facilitate testing under controlled cyclic loading conditions. A working space approximately 450 by 450 mm (18 by 18 in.) is desirable to accommodate the specimen grips and the installation of a chamber for environmental control. In-line tension grips, shown in Fig. 4, are used for transmitting the load to the specimen.

### 6.2 Slip Gage and Signal Conditioner:

6.2.1 The shear strain in adhesive layers is usually small. Thin layers of relatively rigid adhesives (greater than 50 MPa (7000 psi)) require an ASTM Class A extensometer. Class B-1 or B-2 extensometers suffice for thicker layers and more flexible adhesives. Extensometer classes are described in Practice E83.

6.2.2 A mechanical-electrical transducer, the linear variable differential transformer (LVDT), is well suited for these tests. The LVDT with suitable signal conditioning will satisfy the requirements of Class B and A extensometers. They are rugged enough to remain fastened to the specimen through failure if the gage is properly designed.

6.2.2.1 The LVDT should have a linear output over a displacement range of  $\pm 2.5$  mm ( $\pm 0.10$  in.) to accommodate adhesive layers varying in shear modulus and thickness.

6.2.2.2 The LVDT transducers with signal conditioner should provide several ranges of displacement resolution—between 0.0005 and 0.5 mm/cm ( $5 \times 10^5$  and 0.05 in./m) of chart paper.

6.2.3 The slip gage shall employ two LVDTs as described in 6.2.2, positioned in such a manner as to measure and compensate for rotation of the adherends as well as slip.

6.2.4 A gage design that has been found to compensate satisfactorily for adherend rotation is shown in Fig. 5, Fig. A1.1, and Fig. A1.2. The gage consists of three components: the gage itself on which two LVDTs are mounted, the follower, and a gage block. The gage and follower attach to opposing adherends by clamping knife edges. One knife edge on each component may be advanced or retracted by a captive screw. The gage block is placed between the gage and follower to align the knife edges. The gage is clamped to the stationary or downward moving adherend and the follower to the upward moving adherend, so the LVDT core moves out of the LVDT during loading. This prevents damage to the LVDT upon

<sup>4</sup> Goland, M., and Reissner, E., "The Stresses in Cemented Joints," *Journal of Applied Mechanics*, November 1944, pp. A17–A27.

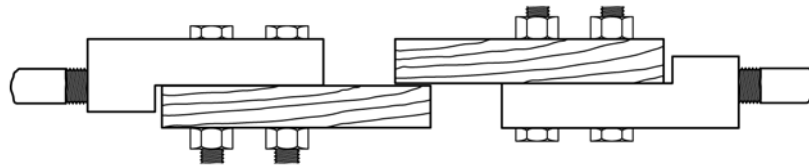

FIG. 4 Incline Tension Grips with Specimen Bolted in Place Ready for Testing

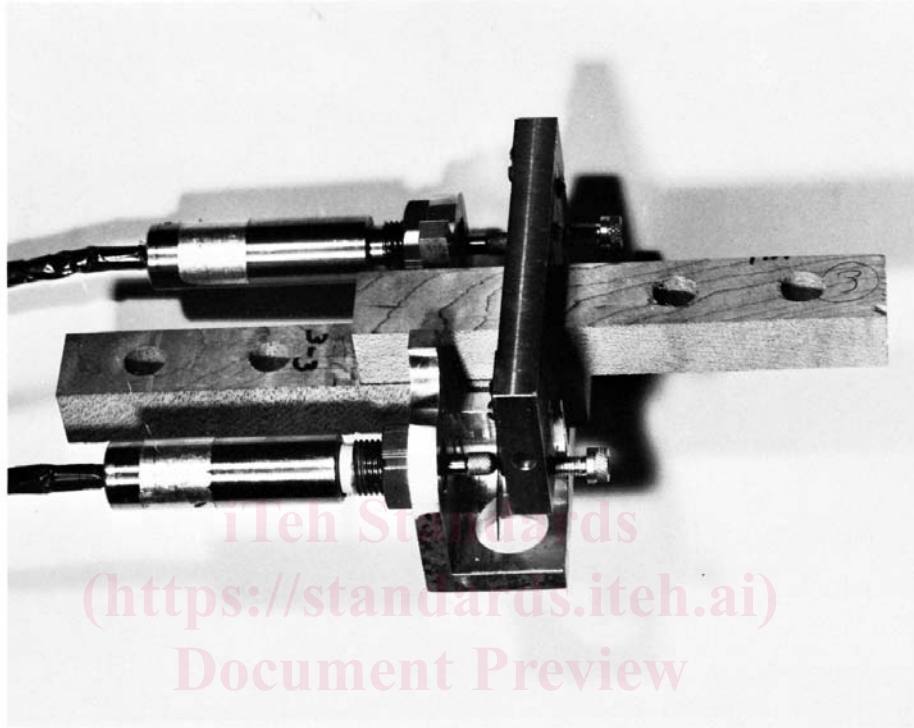

FIG. 5 Dual Transducer Slip Gage Mounted on a Thick Adherend Lap Specimen

<https://standards.iteh.ai/catalog/standards/sist/50ca5901-9cb4-4e94-b9ad-f21253aba107/astm-d3983-982011>

failure of the specimen. The follower is equipped with a knurled adjustment screw for each LVDT. These screws are used to null mechanically and electrically each LVDT prior to testing.

6.2.5 The slip gage shall be equipped with a switching and signal-conditioning device to permit recording the signal from each LVDT individually or the sum of the signals.

6.2.6 The LVDTs and slip gage components should be fabricated of corrosion-resistant materials.

6.3 *X-Y Recorder*—A general-purpose X-Y recorder with inputs compatible with the outputs of the load cell and slip gage is required. The load is connected to the recorder of the Y-axis and the LVDTs to the X-axis. The recorder should have several precalibrated input ranges and a preamplifier to scale the transducer signals conveniently. The required ranges will depend upon the voltage output of the load cells and the LVDT transducers and their signal conditioner.

#### 6.4 *Environmental Chamber:*

6.4.1 A controlled test environment is required to determine the effects of temperature and moisture and to minimize variability in test results due to changes in environmental conditions.

6.4.2 The combined test chamber and conditioning unit should be capable of maintaining a constant temperature within the limits from  $23$  to  $71 \pm 1^\circ\text{C}$  ( $80$  to  $160 \pm 2^\circ\text{F}$ ), and constant relative humidity within the limits of  $44$  to  $98 \pm 2\%$  at a given temperature.

6.4.3 A suitable test chamber is described in [Annex A2](#).

## 7. Materials

### 7.1 *Adherend:*

7.1.1 *Wood*—Hard maple (*Acer saccharum* or *Acer nigrum*) with a minimum specific gravity of 0.60 is the standard wood adherend for this test method. Other dense species with comparable modulus of elasticity such as yellow birch, Douglas fir, western hemlock, or southern pine may be used. The lumber shall be of straight grain and free of defects, including knots, birdseye, short grain, decay, and any unusual discolorations within the shearing area. Criteria for lumber selection shall be those described in Test Method [D905](#).

7.2 *Metal*—Use cold-rolled steel or aluminum-alloy bar stock, machined to a surface finish of  $16\ \mu\text{in.}$  or better in the bond area, for adhesives that contain no volatile constituents,



and have a shear modulus in the range from 50 to 700 MPa (7 000 to 100 000 psi).

7.3 *Adhesives*—Any adhesive with a shear modulus not exceeding 50 MPa (7000 psi) can be tested using hard maple adherends. More rigid adhesives can be tested using stiffer although nonpermeable adherends if the adhesive does not require the elimination of volatile solvents during cure. In this case, adhesives with shear modulus in the range from 50 to 250 MPa (7 000 to 36 000 psi) may be tested with aluminum adherends. Adhesives having shear modulus in the range from 250 to 700 MPa (36 000 to 100 000 psi) shall be tested with steel adherends.

## 8. Test Specimen

8.1 The standard adherend for the tension lap-shear specimen shall be a block 150 by 16 by 20 mm (5.9 by 0.63 by 0.79 in.) which can be bonded on the 20-mm face in overlaps ranging from 4 to 50 mm (0.16 to 1.97 in.).

8.2 Drill holes in the lap-shear specimen in order to bolt the specimen firmly to the fixtures of the crosshead and load cell of the test machine.

### 8.3 Specimen Preparation:

#### 8.3.1 Wood Specimens:

8.3.1.1 Cut lumber into boards 19 by 95 by 350 mm (0.75 by 3.75 by 13.8 in.) with the 350-mm dimension parallel to the grain direction. Condition the boards to an equilibrium moisture content of 7 to 10 %, on an oven-dry weight basis, or to the moisture content recommended by the manufacturer of the adhesive being tested (Note 1). Lightly surface the side of the board to be bonded using a hand-fed jointer having well-sharpened and aligned knives. Surface the opposite face of the board in a planer set to provide a finished board thickness of  $16 \pm 0.2$  mm ( $0.63 \pm 0.008$  in.). The planer should be well-maintained with sharp knives and set for minimum thickness variation from one side of the board to the other.

NOTE 1—A procedure for determining moisture content is described in Sections 124 to 127 of Test Methods D143.

NOTE 2—For safety as well as accuracy, a carrier board wider and longer than the panel boards, and fitted with a 6-mm (0.25-in.) thick stop on one end, should be used to feed the panel boards through the planer. The carrier board should be carefully conditioned and surfaced accurately for thickness and stored in a conditioned room between uses.

8.3.1.2 After surfacing, cut each board into two blocks 90 by 150 mm (3.54 by 5.91 in.), mark them as a pair, and return them to the conditioning atmosphere. Bond the blocks within 24 h of the time the boards were surfaced.

8.3.1.3 Shims placed between the adherends or used in combination with a gluing jig are required to control bondline thickness. A suitable jig is shown in Fig. 6. Shims are placed between the jig base and the top block (which is clamped in

place) to squeeze out excess adhesive, and leave the desired volume of adhesive between the two adherends. The bottom block is free to move upward to allow for bondline shrinkage as volatiles are lost during cure. Adhesive systems with 100 % total solids will require shims equal in thickness to that of the desired bondline. Bonded blocks should remain in the jig for 24 h followed by additional time in the conditioned atmosphere as required to assure full strength development.

8.3.1.4 Different overlap lengths can be produced by saw kerfs through an adherend to the bondline. The method for determining allowable overlap length is described in 11.4.

8.3.1.5 After adjustment of overlap length, the bonded blocks can be cut into specimens 20 mm (0.79 in.) wide to yield four specimens each. Cut specimen ends to length and drill holes for bolt attachment to the test apparatus, as shown in Fig. 7.

NOTE 3—Care must be taken to drill the holes exactly on the central longitudinal axis of each adherend to minimize adherend rotation for this source. The use of a marked jig, centering punch and spur, or doweling drill bit are recommended.

#### 8.3.2 Metal Specimens:

8.3.2.1 Metal specimens shall be bonded from individual adherends rather than being cut from a bonded block as described for wood. Machine single adherends that can be reused from bar stock to the dimensions 20 by 20 by 150 mm (0.79 by 0.79 by 5.91 in.) and grind to a final thickness of  $16 \pm 0.025$  mm ( $0.63 \pm 0.001$  in.). Drill holes in one end of each single adherend for bolt attachment to the test machine grips.

8.3.2.2 Before bonding, degrease the surfaces of the adherends and prepare them by the procedure recommended by the adhesive manufacturer, or by one of the procedures described in Guide D2651. Bond the adherends within 24 h after surface preparation.

8.3.2.3 Bond the individual adherends in a jig similar to that shown in Fig. 6, except that the top and bottom plates of the jig should have slots to align the adherends in the correct position. Pin the two halves of the jig to ensure proper alignment. Control the overlap length by inserting suitably sized blocks at the end of the adherends, away from the bondline. Metal specimens may be bonded by either hot-pressing or cold-pressing. After a suitable postcure period, trim adhesive squeezeout flush with the adherends with a razor blade.

## 9. Conditioning

9.1 Make load-slip measurements at temperatures and moisture levels designated either by the party requesting these tests, or in the specification calling for this test method.

9.2 In the absence of specific requirements, use as standard conditions  $23 \pm 2^\circ\text{C}$  ( $73 \pm 4^\circ\text{F}$ ) and  $50 \pm 5\%$  relative humidity. The conditions in Table 1 are recommended for tests

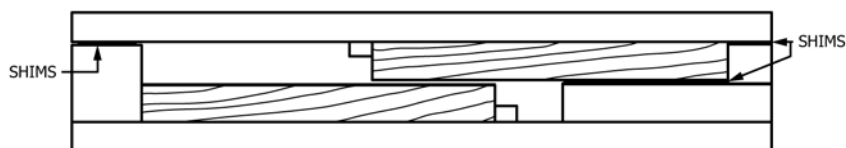

FIG. 6 Gluing Jig for Controlling Initial Wet Glueline Thickness

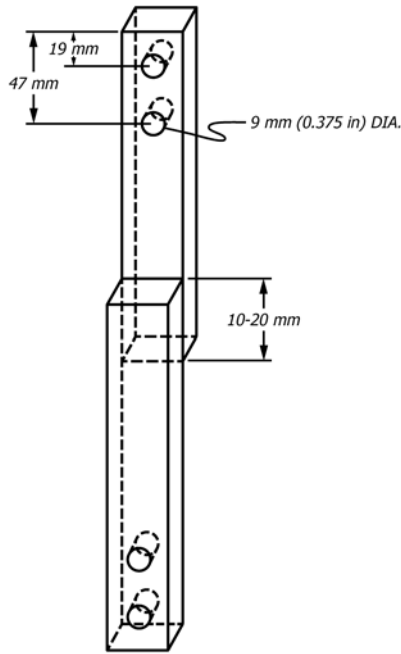

FIG. 7 Standard Thick Adherend Tensile Lap Shear Specimen Showing the 10 to 20-mm Overlap Used to Establish a Trial Shear Modulus

TABLE 1 Relative Humidity Required to Maintain Equilibrium Moisture Contents of Wood at Three Different Temperatures<sup>A</sup>

Wood Equilibrium Moisture Content, %	Relative Humidity, % Required at		
	23°C (73°F)	49°C (120°F)	71°C (160°F)
8	44	51	60
19	87	91	94
30	soak	soak	soak

<sup>A</sup> Values from Table 1 of "Relative Humidity and Equilibrium Moisture Content Graphs and Tables for Use in Kiln Drying Lumber," Forest Products Laboratory Report No. 1651, 1963.

to evaluate environmental effect on adhesives for building construction. Further guidelines are provided in Practice D1151.

9.3 Specimens are most conveniently conditioned at 23°C (73°F) to the desired equilibrium moisture condition. A satisfactory method is the use of saturated salt solutions in closed containers, as described in Practice E104. Prior to test, place specimens in equilibrium at 23°C in the test chamber set at the desired temperature and the relative humidity that will result in the same moisture equilibrium as at 23°C. Residence time in the chamber before testing can begin is reduced to the time required to achieve temperature uniformity throughout the specimen.

## 10. Measurement of Bond Dimensions

10.1 Measure the length and width of the bond area to the nearest 0.5 mm (0.02 in.), and calculate the bond area to the nearest 1 mm<sup>2</sup>.

10.2 Measure the bond layer thickness at each of the four corners, and calculate the average thickness. A suitable device

TABLE 2 Five Test Procedures for Determining Load-Slip Behavior of Each Specimen

Test Procedure	Purpose <sup>A,B</sup>	Loading Condition <sup>C</sup>
1	Preload grips and specimen, check recorder scaling.	0–0.1P–0 <sup>D</sup>
2	Record load and the slip measured by the LVDT A output.	0–0.1 P–0 <sup>D</sup>
3	Record load and the slip measured by the LVDT B output.	0–0.1 P–0 <sup>D</sup>
4	Record load and the slip measured by the combined (summed) LVDT A + LVDT B output.	0–0.1P–0 <sup>D</sup>
5	Record load and the slip measured by the combined LVDTs.	0–P

<sup>A</sup> The load-slip diagram for the first load-unload cycle will generally have a different shape and slope than subsequent loadings.

<sup>B</sup> Recorder scaling should be adjusted to produce a slope of the load-slip diagram between 30 and 60°.

<sup>C</sup> P is the maximum load the joint will withstand as established in the preliminary tests to estimate shear modulus and strength.

<sup>D</sup> The value of 0.1 P<sub>max</sub> is a recommendation. Its selection for secant modulus determination is an arbitrary one. For many adhesives, the initial portion of the load-slip diagram is fairly linear up to 0.1 P<sub>max</sub> and thus may approximate a useful working load. The party or specification calling for the performance of this test may specify any other value as, for example, a load based on a predetermined allowable working stress.

for this measurement is a binocular microscope at 80× magnification, fitted with an eyepiece scale having 100 divisions per millimetre.

## 11. Test Specimen Design

11.1 There are three steps in the specimen design: (1) adherend selection; (2) adhesive shear modulus estimation; and (3) evaluation of joint geometry. These criteria based on Goland and Reissner's<sup>4</sup> work are developed and discussed in a report by River and Gillespie.<sup>5</sup>

11.2 Solvent-dispersed adhesives must bond permeable adherends. In this test method, hard maple is the standard permeable adherend. One hundred percent reactive adhesive may be tested with either wood, aluminum, or steel adherends. The maximum adhesive shear modulus that can be accurately measured is 50 MPa (7250 psi) with maple adherends, 250 MPa (36 000 psi) with aluminum, and 700 MPa (101 500 psi) with steel adherends.

NOTE 4—These limitations are based on the condition of the Goland-Reissner theory that the ratio of adherend thickness over elastic tensile modulus  $t/E$  be less than adhesive thickness over 30 times the shear modulus  $\eta/30G$  or  $t/E < \eta/30G$  assuming a maximum practical adhesive thickness of 1.5 mm (0.06 in.).

### 11.3 Shear Modulus Estimation:

11.3.1 An estimate of the adhesive shear modulus is required for joint design. Obtain the estimate from specimens having a trial overlap of 20 mm ( $c = 10$  mm). Test two to four trial specimens in accordance with Procedure 5 of Table 2. Conduct the tests at 23°C and 50 % relative humidity.

11.3.2 Use data obtained from the load-slip curves to calculate the estimated shear modulus ( $\hat{G}$ ), as described in 13.1.

<sup>5</sup> River, B. H., and Gillespie, R. H., *Measurement of Shear Modulus and Shear Strength of Adhesives*. Report prepared for the Department of Housing and Urban Development, Office of Policy and Research, by the Forest Products Laboratory, Forest Service, U.S. Department of Agriculture, 1978.