

ISO/TC 213

Secretariat: BSI

Voting begins on:  
2023-01-30

Voting terminates on:  
2023-03-27

---

---

## Geometrical product specifications (GPS) — Dimensional and geometrical tolerances for moulded parts —

Part 4:

### Rules and general tolerances for castings using profile tolerancing in a general datum system

*Spécification géométrique des produits (GPS) — Tolérances  
dimensionnelles et géométriques pour les pièces moulées —*

*Partie 4: Tolérances générales pour les pièces moulées par  
tolérancement de profil dans un système général de références  
spécifiées*

RECIPIENTS OF THIS DRAFT ARE INVITED TO SUBMIT, WITH THEIR COMMENTS, NOTIFICATION OF ANY RELEVANT PATENT RIGHTS OF WHICH THEY ARE AWARE AND TO PROVIDE SUPPORTING DOCUMENTATION.

IN ADDITION TO THEIR EVALUATION AS BEING ACCEPTABLE FOR INDUSTRIAL, TECHNOLOGICAL, COMMERCIAL AND USER PURPOSES, DRAFT INTERNATIONAL STANDARDS MAY ON OCCASION HAVE TO BE CONSIDERED IN THE LIGHT OF THEIR POTENTIAL TO BECOME STANDARDS TO WHICH REFERENCE MAY BE MADE IN NATIONAL REGULATIONS.



---

---

Reference number  
ISO/FDIS 8062-4:2023(E)

© ISO 2023

iTeh STANDARD PREVIEW  
(standards.iteh.ai)

ISO/FDIS 8062-4

<https://standards.iteh.ai/catalog/standards/sist/c5d2b40e-a33e-4cc8-ba8a-c4d018bfa7d7/iso-fdis-8062-4>



**COPYRIGHT PROTECTED DOCUMENT**

© ISO 2023

All rights reserved. Unless otherwise specified, or required in the context of its implementation, no part of this publication may be reproduced or utilized otherwise in any form or by any means, electronic or mechanical, including photocopying, or posting on the internet or an intranet, without prior written permission. Permission can be requested from either ISO at the address below or ISO's member body in the country of the requester.

ISO copyright office  
CP 401 • Ch. de Blandonnet 8  
CH-1214 Vernier, Geneva  
Phone: +41 22 749 01 11  
Email: [copyright@iso.org](mailto:copyright@iso.org)  
Website: [www.iso.org](http://www.iso.org)

Published in Switzerland

# Contents

Page

<b>Foreword</b> .....	<b>v</b>
<b>Introduction</b> .....	<b>vi</b>
<b>1 Scope</b> .....	<b>1</b>
<b>2 Normative references</b> .....	<b>1</b>
<b>3 Terms and definitions</b> .....	<b>2</b>
<b>4 Graphical symbols</b> .....	<b>5</b>
<b>5 Product definition type indicator</b> .....	<b>6</b>
5.1 Single and combined product definitions.....	6
5.2 Final moulded part product definitions.....	6
5.3 Intermediate machined moulded part product definitions.....	7
5.4 Final machined moulded part product definition.....	7
5.5 Identifier for machining by the supplier.....	7
<b>6 Product definition indications</b> .....	<b>8</b>
6.1 Surface texture symbols.....	8
6.2 Part condition identifiers.....	8
6.2.1 General.....	8
6.2.2 Surface texture.....	9
6.2.3 Linear sizes.....	10
6.2.4 Linear dimensions and individually indicated dimensional tolerances.....	10
6.2.5 Theoretically exact dimensions (TEDs).....	10
6.2.6 Geometrical tolerances and datums.....	10
6.3 Required machining allowance (RMA).....	12
6.3.1 General.....	12
6.3.2 General RMA.....	12
6.3.3 Individual RMA.....	12
6.4 Draft angles.....	12
<b>7 Indication of general tolerances</b> .....	<b>14</b>
7.1 General tolerances according to this document.....	14
7.2 General surface profile tolerance.....	14
<b>8 Types of specifications</b> .....	<b>15</b>
8.1 General.....	15
8.2 Specification of final moulded part condition.....	15
8.2.1 Overview of specification of final moulded part condition.....	15
8.2.2 Specification of final moulded part condition by the casting calculation method.....	15
8.2.3 Specification of final moulded part condition by the multiple tolerancing method.....	16
8.3 Specification of intermediate machined moulded part conditions.....	16
8.4 Specification of final machined moulded part condition.....	17
<b>9 Tolerancing</b> .....	<b>17</b>
9.1 General.....	17
9.2 Tolerancing of final moulded parts.....	17
9.2.1 Recommendations.....	17
9.2.2 Drafts.....	18
9.3 Tolerancing of intermediate machined moulded parts.....	18
9.4 Tolerancing of final machined moulded parts.....	18
9.4.1 General.....	18
9.4.2 Drafts.....	18
9.4.3 Multiple tolerancing method.....	18
<b>10 Rules</b> .....	<b>19</b>

10.1	Rule A: Application of general tolerances for castings .....	19
10.2	Rule B: General surface profile tolerances .....	19
10.3	Rule C: General datum system RST .....	20
10.4	Rule D: Tolerances overruling the general surface profile tolerances.....	20
10.5	Rule E: Additional tolerances.....	21
10.6	Rule F: Machined condition .....	21
10.7	Rule G: Required machining allowances (RMA).....	21
10.8	Rule H: Draft angle (taper).....	21
10.9	Rule I: Wall thickness .....	21
<b>11</b>	<b>General tolerances .....</b>	<b>22</b>
<b>12</b>	<b>Required machining allowances (RMAs) .....</b>	<b>23</b>
<b>13</b>	<b>Draft angles .....</b>	<b>24</b>
<b>14</b>	<b>General product definition indication.....</b>	<b>26</b>
<b>Annex A</b>	<b>(normative) Proportions and dimensions of graphical symbols .....</b>	<b>28</b>
<b>Annex B</b>	<b>(informative) Proposed process for general tolerancing castings.....</b>	<b>30</b>
<b>Annex C</b>	<b>(informative) Examples for the multiple tolerancing method .....</b>	<b>31</b>
<b>Annex D</b>	<b>(informative) Drawing examples .....</b>	<b>33</b>
<b>Annex E</b>	<b>(informative) Selection of general tolerances.....</b>	<b>39</b>
<b>Annex F</b>	<b>(informative) Selection of required machining allowances (RMA).....</b>	<b>40</b>
<b>Annex G</b>	<b>(informative) Example of using general tolerances .....</b>	<b>41</b>
<b>Annex H</b>	<b>(normative) Calculation of the nominal dimension of the moulded condition — casting calculation method .....</b>	<b>44</b>
<b>Annex I</b>	<b>(informative) Relationship to the GPS matrix model .....</b>	<b>47</b>
<b>Bibliography</b>	<b>.....</b>	<b>48</b>

## Foreword

ISO (the International Organization for Standardization) is a worldwide federation of national standards bodies (ISO member bodies). The work of preparing International Standards is normally carried out through ISO technical committees. Each member body interested in a subject for which a technical committee has been established has the right to be represented on that committee. International organizations, governmental and non-governmental, in liaison with ISO, also take part in the work. ISO collaborates closely with the International Electrotechnical Commission (IEC) on all matters of electrotechnical standardization.

The procedures used to develop this document and those intended for its further maintenance are described in the ISO/IEC Directives, Part 1. In particular, the different approval criteria needed for the different types of ISO documents should be noted. This document was drafted in accordance with the editorial rules of the ISO/IEC Directives, Part 2 (see [www.iso.org/directives](http://www.iso.org/directives)).

Attention is drawn to the possibility that some of the elements of this document may be the subject of patent rights. ISO shall not be held responsible for identifying any or all such patent rights. Details of any patent rights identified during the development of the document will be in the Introduction and/or on the ISO list of patent declarations received (see [www.iso.org/patents](http://www.iso.org/patents)).

Any trade name used in this document is information given for the convenience of users and does not constitute an endorsement.

For an explanation of the voluntary nature of standards, the meaning of ISO specific terms and expressions related to conformity assessment, as well as information about ISO's adherence to the World Trade Organization (WTO) principles in the Technical Barriers to Trade (TBT), see [www.iso.org/iso/foreword.html](http://www.iso.org/iso/foreword.html).

This document was prepared by Technical Committee ISO/TC 213, *Dimensional and geometrical product specifications and verification*.

This second edition cancels and replaces the first edition (ISO 8062-4:2017), which has been technically revised.

The main changes are as follows:

- overall clarification regarding better applicability according to the ISO GPS system;
- overall revision of tables and figures for plausibility;
- new symbols for draft angles with symmetrical/unsymmetrical tolerance zones as already included in the model geometry or drawing outlines have been added;
- requirements for the indication in the product definition (new [Clauses 5](#), [6](#) and [7](#)) and types of specifications (new [Clause 8](#)) have been added;
- Rule I concerning the wall thickness has been added;
- [Clause 9](#) and [Annex G](#) have been added, expanding the information previously given in former Annex A;
- new [Annexes A](#), [B](#) and [C](#) have been added;

A list of all parts in the ISO 8062 series can be found on the ISO website.

Any feedback or questions on this document should be directed to the user's national standards body. A complete listing of these bodies can be found at [www.iso.org/members.html](http://www.iso.org/members.html).

## Introduction

This document is a geometrical product specification (GPS) standard and is to be regarded as a complementary ISO GPS standard. It influences chain link B of the chain of standards on size, form, orientation and location.

The ISO GPS matrix model given in ISO 14638 gives an overview of the ISO GPS system, of which this document is a part. The fundamental rules of ISO GPS given in ISO 8015 apply to this document and the default decision rules given in ISO 14253-1 apply to specifications made in accordance with this document, unless otherwise indicated.

For more detailed information about the relation of this document to other standards and the GPS matrix model, see [Annex I](#).

This document gives terms and definitions and symbols for product definition indications for tolerancing of moulded parts, which are to be used in addition to the usual standards on geometrical product specifications (GPS), such as ISO 1101, ISO 5458 and ISO 5459.

According to this document,  $\pm$  tolerances are only used for sizes and the following non-features of size: wall thicknesses, fillets and chamfers. Positional tolerances are also applied for sizes specified with  $\pm$  tolerances. For all other tolerancing purposes, geometrical tolerances according to ISO 1101 are used. For all other non-features of size, such as step dimension,  $\pm$  tolerances are not recommended. See the ISO 14405 series for background information.

This document defines a system of tolerance grades, draft angle (taper) grades and machining allowance grades for cast metals and their alloys.

ISO/TS 8062-2 states, in relation to the accumulation method where general dimensional tolerances according to ISO 8062-3 are used, that there is not yet a clearly defined way in the context of the future system of ISO GPS standards to apply the rules for calculating the final moulded part nominal dimensions from the final machined moulded part nominal dimensions, taking into account the miscellaneous influences. One of the reasons for this problem is the lack of a proper workpiece datum system.

The general dimensional tolerances apply independently from each other (without a datum system). It is difficult or even impossible to assess what the overall shape of the workpiece can become.

The general dimensional tolerances ( $\pm$ tolerances) of ISO 8062-3 apply not only to sizes but also to centre distances and dimensions defining profile contours. This is in contradiction to the ISO GPS rules (e.g. ISO 14405-2).

The general tolerances of ISO 8062-4 are not in compliance with the rules of ISO 22081 with respect to the general geometrical tolerancing.

Furthermore, with 3D CAD the nominal dimensions are not always visible in the model. As the general dimensional tolerances depend on the nominal dimensions, they cannot be used anymore when only the CAD model is available. To avoid these problems this document was developed as a parallel approach fully conforming with the ISO GPS rules given in, for example, ISO 14405-2 by introducing profile tolerancing and a datum system.

If there is no datum system specified or if the datum surfaces are to be machined after moulding then only ISO 8062-3 can be applied.

For the development of a new product, it is strongly recommended that customer and foundry should discuss and agree on the method of tolerancing to be applied to the product. This also includes casting method, calculation methods, cast material and draft angles, which are crucial for the process.

# Geometrical product specifications (GPS) — Dimensional and geometrical tolerances for moulded parts —

## Part 4: Rules and general tolerances for castings using profile tolerancing in a general datum system

### 1 Scope

This document specifies the rules for geometrical dimensioning and tolerancing of final moulded parts and parts machined out of moulded parts. It also specifies rules and conventions for the indications of these requirements in technical product documentation and specifies the proportions and dimensions of the graphical symbols to be used.

This document provides symbols for identifying the relative completeness of the moulded features and parts. These graphical symbols differ from the graphical symbols for surface texture according to ISO 1302,<sup>1</sup>

1 Cancelled and replaced by ISO 21920-1.

This document specifies general geometrical tolerances using surface profile tolerances related to a general datum system that remains on the final part. It also specifies machining allowances and draft angles (tapers) for castings in all cast metals and their alloys produced by various casting manufacturing processes.

This document establishes the general principles for presentation of general geometrical tolerances that apply to 2D technical drawings in all disciplines and trades but which are also applicable to 3D applications.

NOTE All figures are shown in 2D views only.

When cast datum surfaces are machined, this document is not applicable.

### 2 Normative references

The following documents are referred to in the text in such a way that some or all of their content constitutes requirements of this document. For dated references, only the edition cited applies. For undated references, the latest edition of the referenced document (including any amendments) applies.

ISO 129-1, *Technical product documentation (TPD) — Presentation of dimensions and tolerances — Part 1: General principles*

ISO 1101, *Geometrical product specifications (GPS) — Geometrical tolerancing — Tolerances of form, orientation, location and run-out*

ISO 1302,<sup>1</sup> *Geometrical Product Specifications (GPS) — Indication of surface texture in technical product documentation*

ISO 1660, *Geometrical product specifications (GPS) — Geometrical tolerancing — Profile tolerancing*

ISO 2692, *Geometrical product specifications (GPS) — Geometrical tolerancing — Maximum material requirement (MMR), least material requirement (LMR) and reciprocity requirement (RPR)*

## ISO/FDIS 8062-4:2023(E)

ISO 5458, *Geometrical product specifications (GPS) — Geometrical tolerancing — Pattern and combined geometrical specification*

ISO 5459, *Geometrical product specifications (GPS) — Geometrical tolerancing — Datums and datum systems*

ISO 7083, *Technical product documentation — Symbols used in technical product documentation — Proportions and dimensions*

ISO 8015, *Geometrical product specifications (GPS) — Fundamentals — Concepts, principles and rules*

ISO 8062-1, *Geometrical product specifications (GPS) — Dimensional and geometrical tolerances for moulded parts — Part 1: Vocabulary*

ISO 8785, *Geometrical Product Specification (GPS) — Surface imperfections — Terms, definitions and parameters*

ISO 10135, *Geometrical product specifications (GPS) — Drawing indications for moulded parts in technical product documentation (TPD)*

ISO 10579, *Geometrical product specifications (GPS) — Dimensioning and tolerancing — Non-rigid parts*

ISO 13715, *Technical product documentation — Edges of undefined shape — Indication and dimensioning*

ISO 14405-1, *Geometrical product specifications (GPS) — Dimensional tolerancing — Part 1: Linear sizes*

ISO 14405-2, *Geometrical product specifications (GPS) — Dimensional tolerancing — Part 2: Dimensions other than linear or angular sizes*

ISO 14405-3, *Geometrical product specifications (GPS) — Dimensional tolerancing — Part 3: Angular sizes*

ISO 16792, *Technical product documentation — Digital product definition data practices*

ISO 21204, *Geometrical product specifications (GPS) — Transition specification*

ISO 22081, *Geometrical product specifications (GPS) — Geometrical tolerancing — General geometrical specifications and general size specifications*

ISO 81714-1, *Design of graphical symbols for use in the technical documentation of products — Part 1: Basic rules*

### 3 Terms and definitions

For the purposes of this document, the terms and definitions given in ISO 1101, ISO 1660, ISO 2692, ISO 5458, ISO 5459, ISO 8062-1, ISO 10135, ISO 10579 and ISO 16792 and the following apply.

ISO and IEC maintain terminology databases for use in standardization at the following addresses:

- ISO Online browsing platform: available at <https://www.iso.org/obp>
- IEC Electropedia: available at <https://www.electropedia.org/>

#### 3.1 moulded feature

feature of a moulded part which has not been machined



**3.2****intermediate machined feature**

feature of a moulded part which has undergone some machining and which subsequently will be machined to its final condition

Note 1 to entry: An intermediate machined feature is typically a roughly machined *moulded feature* (3.1).

Note 2 to entry: An intermediate machined feature can be used as a datum for subsequent machining of the moulded part.

**3.3****final machined feature**

feature of a moulded part which has been machined to its final condition

**3.4****final moulded part**

moulded part after fettling (if any)

Note 1 to entry: A final moulded part only consists of features which are moulded and have not been finished except by fettling.

**3.5****intermediate machined moulded part**

moulded part which has undergone some machining and which subsequently will be machined to its final condition

Note 1 to entry: An intermediate machined moulded part consists of at least one *moulded feature* (3.1) to be subsequently machined or at least one *intermediate machined feature* (3.2). In addition, it consists of moulded features not to be machined (if any) and *final machined features* (3.3) (if any).

Note 2 to entry: An intermediate machined moulded part can be produced from a *final moulded part* (3.4) or from another intermediate machined moulded part.

**3.6****final machined moulded part**

moulded part which has been machined to its final condition

Note 1 to entry: A final machined moulded part consists of *final machined features* (3.3) and can include *moulded features* (3.1) not to be machined. A final machined moulded part cannot include intermediate machined moulded features.

Note 2 to entry: A final machined moulded part can be produced from a *final moulded part* (3.4) or from an *intermediate machined moulded part* (3.5).

**3.7****moulded part condition**

manufacturing stage of a moulded part

Note 1 to entry: Listed in chronological order of manufacturing, a moulded part can be in a *final moulded part* (3.4) condition, *intermediate machined moulded part* (3.5) condition or *final machined moulded part* (3.6) condition.

Note 2 to entry: Only one final moulded part condition exists.

Note 3 to entry: Various intermediate machined moulded part conditions can exist.

Note 4 to entry: Only one final machined moulded part condition can exist.

Note 5 to entry: A moulded part does not need to exist in an intermediate machined moulded part condition before the final machined moulded part condition.

Note 6 to entry: Heat treatment or straightening (correction of unintended distortion) can be carried out in any moulded part condition.

**3.8  
product definition**

<of a moulded part> drawing or a 3D model representing the product

**3.9  
single product definition**

*product definition* (3.8) of a moulded part giving requirements for one *moulded part condition* (3.7) only

**3.10  
combined product definition**

product definition of a moulded part giving requirements for more than one *moulded part condition* (3.7)

**3.11  
draft angle  
taper**

value of inclination (angle) that is added to a geometrical feature of a pattern or mould to ensure the removal of the pattern or moulded part from the mould

**3.12  
external draft angle**

*draft angle* (3.11) on a surface that has no opposite surface in the direction outward of the part

Note 1 to entry: See [Figure 1](#).

**3.13  
internal draft angle**

*draft angle* (3.11) on a surface that has an opposite surface in the direction outward of the part

Note 1 to entry: See [Figure 1](#).

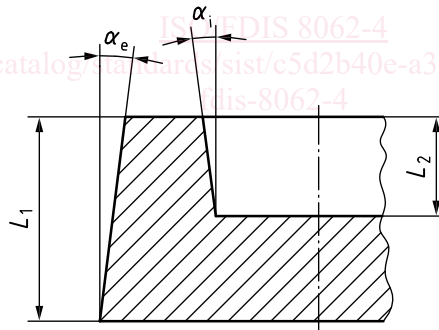

**Key**

- $L_1$  length of the external feature
- $L_2$  length of the internal feature
- $\alpha_e$  external draft angle
- $\alpha_i$  internal draft angle

**Figure 1 — External and internal draft angles**

**3.14  
draft angle increasing the tolerance of feature(s)**

*draft angle* (3.11) which is added to the model geometry and included in the tolerance zone

Note 1 to entry: See [Figure 17 d](#)).

**3.15**

**general datum system RST**

datum system according to ISO 5459, locking all degrees of freedom and used for the general tolerance

Note 1 to entry: [Annex G](#) provides an example of using general tolerances. For the general datum system RST, see [Figure G.2](#).

Note 2 to entry: It is recommended that the datum feature identifiers R, S, and T are used for the general datum systems for moulded parts.

Note 3 to entry: It is recommended that a datum target system RST is used, see [Figure G.1](#).

Note 4 to entry: The datum letters R, S, T are reserved for the general datum system, see [10.3](#).

**3.16**

**wall thickness**

minimum dimension between two surfaces (external and internal) enclosing solid material

Note 1 to entry: The surface can be planar, cylindrical, complex or any combination thereof.

**4 Graphical symbols**







[Table 1](#) gives an overview of the graphical symbols used in this document. Their proportions and dimensions shall be as specified in [Annex A](#).

**Table 1 — Graphical symbols**

Symbol	Description	Source
	moulded surface <sup>a</sup>	ISO 1302
	machined surface <sup>a</sup>	ISO 1302
	moulded or machined surface <sup>a</sup>	ISO 1302
	surface profile tolerance	ISO 1101
	positional tolerance	
	theoretically exact dimension	
	datum of datum target	ISO 5459
	datum target, fixed, movable	
Surfaces without tolerance indication: 	indication of general tolerance	<a href="#">10.1</a> , <a href="#">10.2</a> , <a href="#">10.3</a>
	parting surface	ISO 10135
	parting surface movable fixed	
	indication of draft angle with symmetrical tolerance zone as already included in the model geometry or drawing outlines	<a href="#">6.4</a>

<sup>a</sup> New symbols for surface roughness in accordance with the ISO 21920 series are being prepared.

**Table 1** (continued)

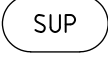
Symbol	Description	Source
	indication of a draft angle with unsymmetrical tolerance zone as already included in the model geometry or drawing outlines	<a href="#">6.4</a>
	draft angle with symmetrical tolerance zone	ISO 10135
	draft angle with unsymmetrical tolerance zone	<a href="#">6.4</a>
	moulded condition	<a href="#">5.2</a>
	intermediate (pre)machined	<a href="#">5.3</a>
	final machined	<a href="#">5.4</a>
	machining by supplier	<a href="#">5.5</a>

<sup>a</sup> New symbols for surface roughness in accordance with the ISO 21920 series are being prepared.

## 5 Product definition type indicator

### 5.1 Single and combined product definitions

The requirements for the three types of moulded part conditions (final moulded, intermediate machined moulded and final machined moulded) can be specified on a combined product definition or separately on single product definitions, as appropriate. [ISO/FDIS 8062-4](https://standards.iteh.ai/catalog/standards/sist/c5d2b40e-a33e-4cc8-ba8a-c4d018bfa7d7/iso-8062-4)

NOTE Some CAD systems allow the representation of multiple types of moulded part conditions in one CAD model.

If use of the symbols in this document makes a combined product definition difficult to read, use single product definitions instead.

Information as to which part condition or conditions the stated specifications on the product definition apply shall be indicated on the product definition in accordance with [5.2](#), [5.3](#), [5.4](#) and [5.5](#). Therefore, the product definition shall indicate which part condition(s) the stated specification applies to.

On combined product definitions, only the outline of the most advanced part condition for which the product definition is valid shall be illustrated. Requirements for the most advanced condition and for the preceding moulded part condition in question shall be stated.

### 5.2 Final moulded part product definitions

If the product definition specifies requirements on a final moulded part, the graphical symbol given in [Figure 2](#) shall be indicated in or near the drawing title block or defined in the product definition data set.



**Figure 2** — Graphical symbol for a final moulded part product definition

### 5.3 Intermediate machined moulded part product definitions

If the product definition specifies requirements on an intermediate machined moulded part, the graphical symbol given in [Figure 3](#) shall be indicated in or near the drawing title block or defined in the product definition data set.



**Figure 3 — Graphical symbol for an intermediate machined moulded part product definition**

If more than one intermediate machined moulded part condition exists on the product definition, they shall be numbered and indicated after the symbol (see [Figure 4](#)).



a)



b)



c)

**Figure 4 — Examples of numbered intermediate machined moulded parts**

If stating general tolerances on a single product definition of an intermediate machined moulded part, for example by referencing ISO 8062-4 or by stating particular general tolerances, these general tolerances apply to the moulded features in the intermediate machined moulded part condition only.

### 5.4 Final machined moulded part product definition

If the product definition states requirements on a final machined moulded part, the graphical symbol given in [Figure 5](#) shall be indicated in or near the title block or defined in the product definition data set.



**Figure 5 — Graphical symbol for final machined moulded part product definition**

If stating general tolerances according to the ISO 8062 series, for example by referencing ISO 8062-4 for castings, on a product definition of a final machined moulded part, these general tolerances apply to the moulded surfaces in the final machined moulded part condition only (see also [Clause 14](#)).

### 5.5 Identifier for machining by the supplier

If there is, for some special reason, a need to identify which part condition specifications a supplier is expected to meet, this can be indicated by the symbol as shown in [Figure 6](#) after the drawing type indicator (see [Figure 7](#)).



**Figure 6 — Symbol for machining by the supplier**

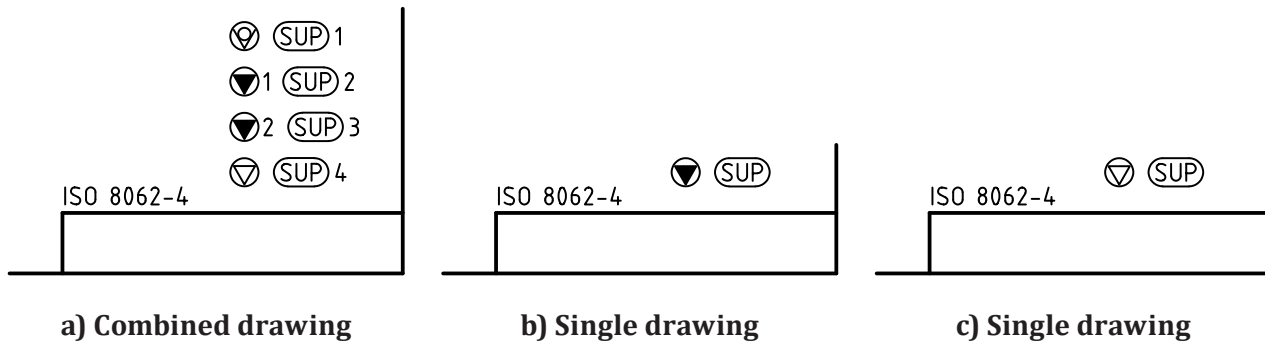

**Figure 7 — Example of SUP indication used together with the product definition type indicator near the drawing title block**

In any case, the written agreement between customer and foundry shall clearly state which part condition and which specification the supplier is expected to meet, irrespective of other part conditions and specifications appearing on the product definition.

## 6 Product definition indications

### 6.1 Surface texture symbols

On combined product definitions, each surface shall be indicated with only one surface texture symbol according to the condition of the surface in question on the most advanced part condition stated on the product definition.

### 6.2 Part condition identifiers

#### 6.2.1 General

Three-part condition identifiers are used for identifying which part condition a specification applies to (see [Figure 8](#)).



**Figure 8 — Part condition identifiers**

The part condition identifier may be omitted on single product definitions.

The use of part condition identifiers is necessary on a combined product definition to state requirements to different part conditions (final moulded, intermediate machined moulded, final machined moulded), see [Figure D.4](#). More than one intermediate machined moulded part condition may be specified. This being the case, the intermediate machined moulded part condition is enumerated in consecutive sequence according to the manufacturing processes.

When a specification is given without a part condition identifier, this specification applies to all part conditions stated on the product definition.

On combined product definitions, requirements on features that remain as moulded in the most advanced part condition according to the product definition may also be given. If not otherwise specified, this type of specification applies to all part conditions according to the product definition, see [Figure 9](#).

When a specification is given with an intermediate part condition, this specification applies for all subsequent part conditions if not otherwise specified.

**6.2.2 Surface texture**

On combined product definitions, surface texture requirements shall be indicated for each part condition using the symbols as shown in [Figure 9](#).

**Product definition indication**

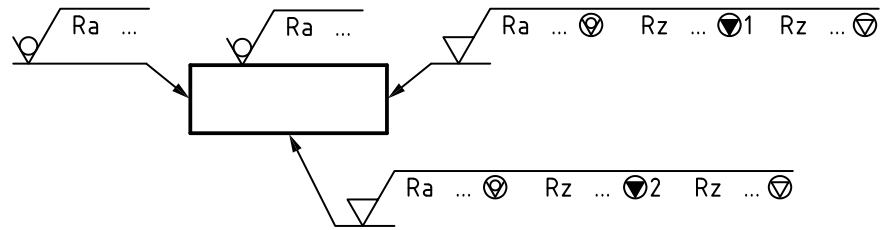

**Condition**

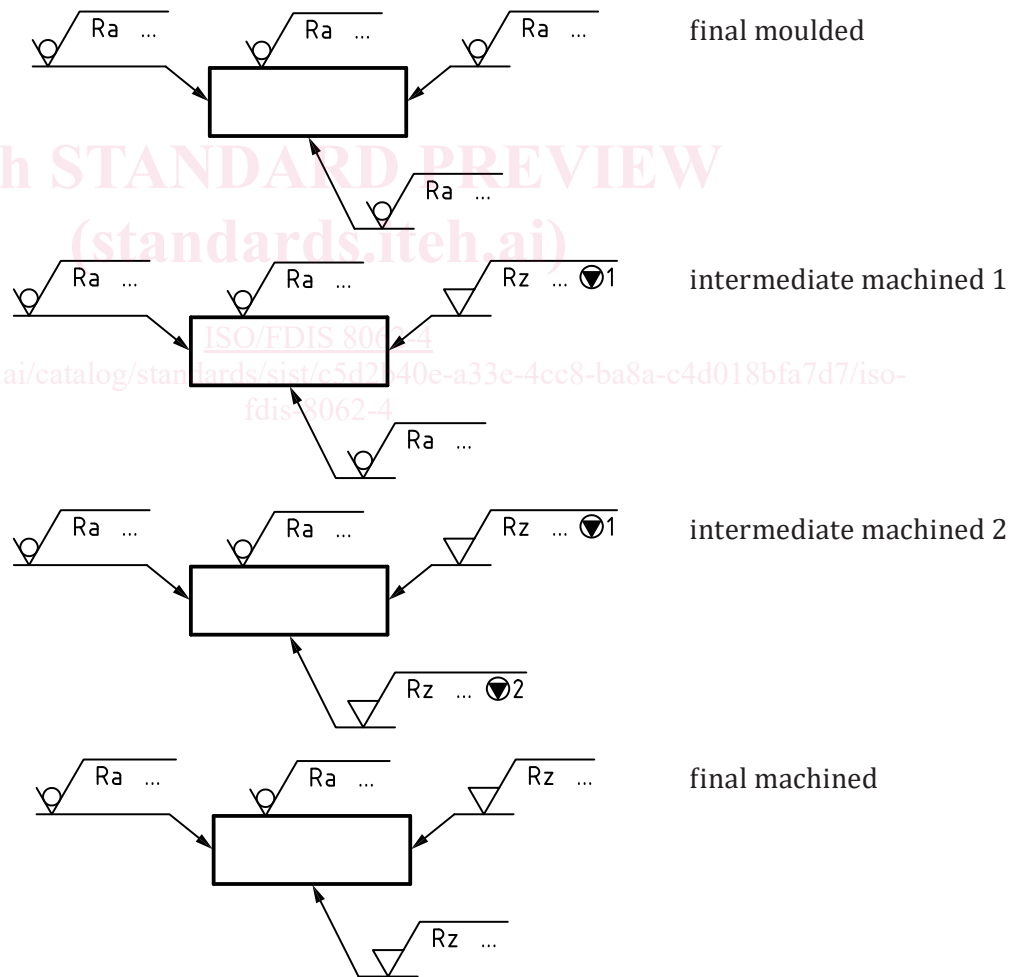

**Figure 9 — Example of a surface texture indication on a combined product definition and its interpretation**