



Standard Test Method for Flammability of Marine Surface Finishes¹

This standard is issued under the fixed designation E1317; the number immediately following the designation indicates the year of original adoption or, in the case of revision, the year of last revision. A number in parentheses indicates the year of last reapproval. A superscript epsilon (ϵ) indicates an editorial change since the last revision or reapproval.

1. Scope

1.1 This fire-test-response standard covers a procedure for measuring fire properties associated with flammable behavior of surface finishes used on noncombustible substrates aboard ship (Note 1). In particular, these include surface finishes intended for use in ship construction such as deck surfacing materials, bulkhead and ceiling veneers including any adhesives used to fasten the veneers to the bulkheads and ceilings, paints, and exposed treatment of insulating materials.

NOTE 1—This test method has been prepared to closely follow the test procedure of IMO Resolution A.653(16) (1).² Optional provisions not applicable to the domestic use of this test method have been deleted.

1.2 Tests performed according to this test method are intended to yield fire properties that, when appropriately interpreted, are potentially useful to select materials and surface treatments that will limit the rapid growth and spread of fire.

1.3 This test method requires a specific range of specimen radiant thermal exposure for measuring fire properties.

1.4 The values stated in SI units are to be regarded as standard. No other units of measurement are included in this standard.

1.5 *This standard is used to measure and describe the response of materials, products, or assemblies to heat and flame under controlled conditions, but does not by itself incorporate all factors required for fire hazard or fire risk assessment of the materials, products, or assemblies under actual fire conditions.*

1.6 *Fire testing is inherently hazardous. Adequate safeguards for personnel and property shall be employed in conducting these tests.*

1.7 *This standard does not purport to address all of the safety concerns, if any, associated with its use. It is the responsibility of the user of this standard to establish appro-*

priate safety and health practices and determine the applicability of regulatory limitations prior to use. For specific hazard statements, see Section 7.

2. Referenced Documents

2.1 *ASTM Standards:*³

E84 Test Method for Surface Burning Characteristics of Building Materials

E162 Test Method for Surface Flammability of Materials Using a Radiant Heat Energy Source

E176 Terminology of Fire Standards

E648 Test Method for Critical Radiant Flux of Floor-Covering Systems Using a Radiant Heat Energy Source

E970 Test Method for Critical Radiant Flux of Exposed Attic Floor Insulation Using a Radiant Heat Energy Source

E1321 Test Method for Determining Material Ignition and Flame Spread Properties

2.2 *Code of Federal Regulations (CFR):*⁴

CFR Title 46, Part 164.009, Noncombustible Materials

2.3 *ISO Standard:*⁵

ISO 5658-2 Reaction to fire tests – Spread of flame-Part 2: Lateral spread on building and transport products in vertical configuration

3. Terminology

3.1 *Definitions*—For definitions of general terms used in this test method, refer to Terminology E176.

3.2 *Definitions of Terms Specific to This Standard:*

3.2.1 *compensating thermocouple, n*—a thermocouple for the purpose of generating an electrical signal representing long-term changes in the stack metal temperatures wherein a fraction of the signal generated is subtracted from the signal developed by the stack-gas thermocouples.

3.2.2 *critical flux at extinguishment, n*—a flux level at the specimen surface corresponding to the distance of farthest

¹ This test method is under the jurisdiction of ASTM Committee E05 on Fire Standards and is the direct responsibility of Subcommittee E05.22 on Surface Burning.

Current edition approved July 1, 2012. Published August 2012. Originally approved in 1990. Last previous edition approved in 2008 as E1317 – 08b. DOI: 10.1520/E1317-12.

² The boldface numbers in parentheses refer to a list of references at the end of this standard.

³ For referenced ASTM standards, visit the ASTM website, www.astm.org, or contact ASTM Customer Service at service@astm.org. For *Annual Book of ASTM Standards* volume information, refer to the standard's Document Summary page on the ASTM website.

⁴ Available from Superintendent of Documents, U.S. Government Printing Office, Washington, DC 20402.

⁵ Available from American National Standards Institute (ANSI), 25 W. 43rd St., 4th Floor, New York, NY 10036, http://www.ansi.org.

advance and subsequent self-extinguishment of the flame on the centerline of a specimen.

3.2.2.1 *Discussion*—The flux reported is based on calibration tests with a special calibration dummy specimen.

3.2.3 *dummy specimen*—a noncombustible (as defined by 46 CFR 164.009) insulating board used for standardizing the operating condition of the equipment, 20 ± 5 mm in thickness with a density of 750 ± 100 kg/m³.

3.2.3.1 *Discussion*—The dummy specimen is mounted in the apparatus in the position of the test specimen and removed only when a test specimen is to be inserted. The term noncombustible is used in a manner consistent with 46 CFR 164.009.

3.2.4 *fume stack*—a box-like duct with thermocouples and baffles through which flames and hot fumes from a burning specimen pass whose purpose is to permit measurement of the heat release from the burning specimen.

3.2.5 *heat for ignition*—the product of time from initial specimen exposure until the flame front reaches the 150-mm position and the flux level at this position, the latter obtained in prior calibration of the apparatus.

3.2.6 *heat for sustained burning*—the product of time from initial specimen exposure until the arrival of the flame front, and the incident flux level at that same location as measured with a dummy specimen during calibration.

3.2.7 *marine board*—an insulation board of 750 ± 100 kg/m³ density that meets the noncombustibility criteria of 46 CFR 164.009.

3.2.8 *measured heat release of specimen*—the observed heat release under the variable flux field imposed on the specimen and measured as defined by this test method.

3.2.9 *mirror assembly*—a mirror, marked and aligned with the viewing rakes, used as an aid in quickly identifying and tracking the flame front progress.

3.2.10 *reverberatory wires*—a wire mesh located in front of, but close to, the radiating surface of the panel heat source which serves to enhance the combustion efficiency and increase the radiance of the panel.

3.2.11 *special calibration dummy specimen*—a dummy specimen as defined by Fig. 1, made of the same material as the dummy specimen, intended only for use in calibration of flux gradient along the specimen.

3.2.12 *viewing rakes*—a set of bars with wires spaced at 50-mm intervals for the purpose of increasing the precision of timing the flame front progress along the specimen.

4. Summary of Test Method

4.1 This test provides methods for evaluating the flammability characteristics of 155 by 800-mm specimens in a vertical orientation. The specimens are exposed to a graded radiant-flux field supplied by a gas-fired radiant panel. Means are provided for observing the times to ignition, spread, and extinguishment of flame along the length of the specimen as well as for measuring the compensated millivolt signal of the stack gas thermocouples as the burning progresses. Results are reported

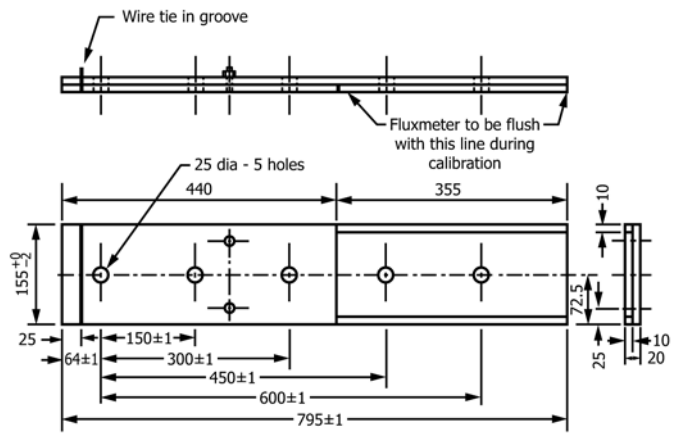

NOTE 1—All dimensions are in millimetres.

FIG. 1 Dummy Specimen for Flux Gradient Calibration

in terms of heat for ignition, heat for sustained burning, critical flux at extinguishment, and heat release of the specimen during burning.

5. Significance and Use

5.1 This test method provides a means for evaluation of the flammable performance of surface finish materials used in constructing and outfitting ships.

5.2 A specimen of the surface finish of concern is mounted on the support material contemplated for use and subjected to a controlled significant radiant-flux exposure.

5.3 All specimens are tested while mounted in a vertical plane.

5.4 The following surfaces are exposed to test:

5.4.1 Bulkhead specimens having surface veneers, fabrics, or painted finishes are tested on one or both exposed sides.

5.4.2 Ceiling finish materials shall be tested on the lower exposed surface.

5.4.3 For ceiling finish materials which are perforated and air backed, tests also shall be conducted on the back (upper) surface of the material.

5.4.4 Deck finish and flooring materials are tested on the upper exposed surface.

5.4.5 Protective membranes or finishes on insulation materials are tested on the air-exposed face or faces.

5.5 This test method provides fire properties that relate to the flammability of the specimens tested. These include ignitability, heat exposure for continued burning, critical flux at extinguishment, and heat-release behavior under varying flux-exposure conditions applied.

5.6 This test method does not provide:

5.6.1 Full information on fire properties of surface-finish materials supported by backing materials other than those tested.

5.6.2 Full information on surface-finish materials when used in other thicknesses than those tested.

5.6.3 Methods for using the fire property measurements as a measure for classifying the fire risk or hazard of the specimens tested.

6. Apparatus

6.1 Test Equipment—Figs. 2-6 show photographs of the equipment as assembled ready for test. Brief parts list for the test equipment assembly includes:

6.1.1 Main Frame (see Fig. 2(a) and Fig. 2 2(b) consisting of two separate sections; the burner frame and the specimen support frame. These two units are bolted together with threaded rods permitting flexibility in mechanical alignment.

6.1.2 Specimen Holders that provide for support of the specimen during test. At least two of these are required. Using three of these will prevent delays resulting from required cooling of holders prior to mounting specimens.

6.1.3 Specimen Fume Stack, fabricated of stainless sheet steel of 0.46 ± 0.05 mm thickness (see Fig. 7) complete with gas and stack-metal compensating thermocouples (also see Fig. 5).

6.1.4 Radiant Panel (2) (see Fig. 4) shall have heated surface dimensions of 280 by 483 mm. The radiant panel consists of an enclosure supporting porous refractory tiles.

6.1.5 Air and Fuel Supply—An air and fuel supply to support combustion on the radiant panel surface, air-flow metering device, gas-control valves, pressure reducer and

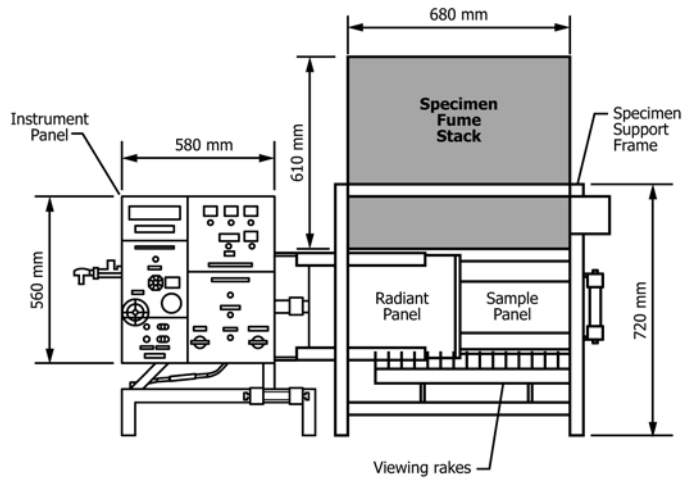

FIG. 2 (b) Test Apparatus Main Frame, Front View (continued)

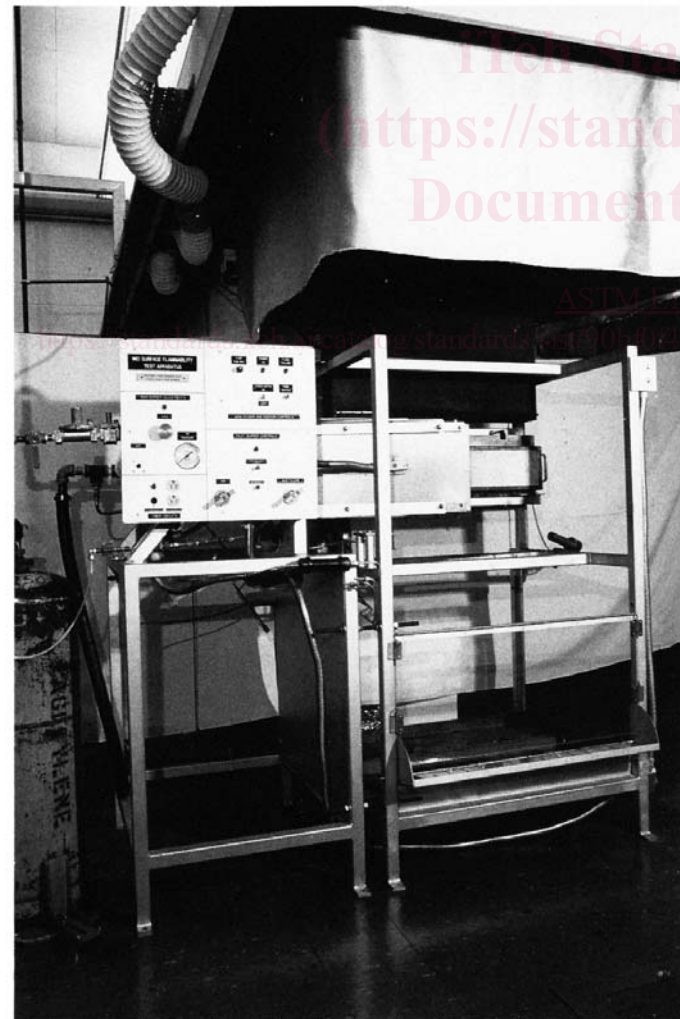
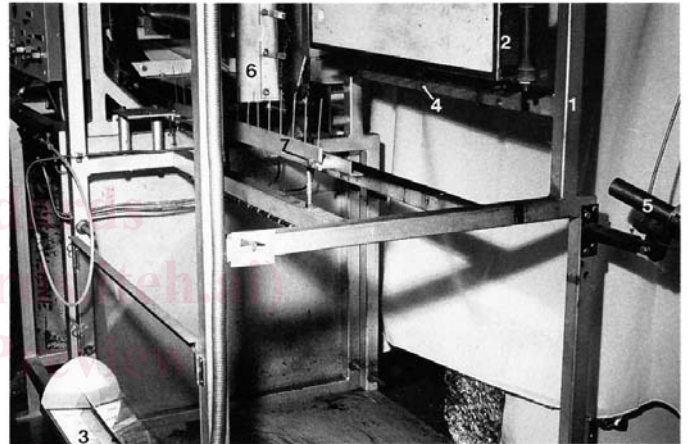

FIG. 2 (a) General View of the Apparatus



- 1—Specimen support frame
- 2—Specimen holder
- 3—Flame-front viewing mirror
- 4—Viewing rake
- 5—Radiation pyrometer
- 6—Radiant panel assembly
- 7—Viewing rake for horizontal specimen not used in this test method

FIG. 3 View From Specimen Insertion Frame

safety controls are all mounted on the burner frame. Requirements are summarized as follows:

6.1.5.1 A regulated air supply of about 30 m³/h [108 000 m³/s] at a pressure sufficient to overcome the friction loss through the line, metering device, and radiant panel. The radiant panel pressure drop amounts to only a few millimetres of water.

6.1.5.2 In the absence of a calibrated flowmeter in the air line, set this flow rate by holding a lighted match with its axis horizontal and close to the panel tile face. The match flame shall not deviate more than 10° from the vertical.

6.1.5.3 The fuel gas used shall be either natural gas or methane. A pressure regulator shall be provided to maintain a constant supply pressure. The gas shall be controlled either by a manually adjusted needle valve or a venturi mixer. The

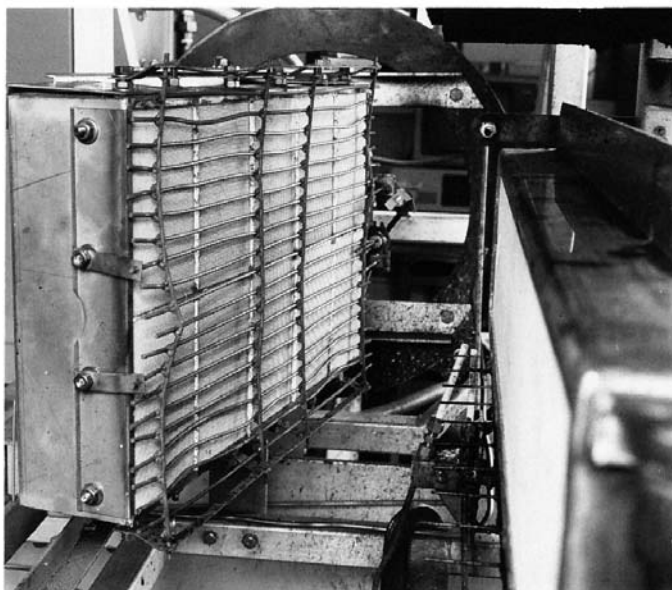

FIG. 4 Radiant Panel Facing Dummy Specimen

venturi mixer will allow control of the flux level of the panel by adjusting only the air valve. Safety devices shall include an electrically operated shutoff valve to prevent gas flow in the event of electric power failure, air pressure failure, or loss of heat at the burner surface. The fuel gas flow requirements shall be 1.0 to 3.7 m³/h at a pressure sufficient to overcome pressure losses.

6.1.6 The specimen holder, pilot-flame holder, fume stack, flame-front viewing rakes, radiation pyrometer, and mirror are all assembled on the specimen support frame. The arrangement of parts on this frame is evident in Fig. 2(a), Fig. 2(b), and Fig. 3.

6.1.7 A dummy specimen of marine board of the thickness and density specified in the test procedure shall be mounted on the apparatus in the position of the specimen except during actual testing.

NOTE 2—Additional information on the construction details of the test equipment can be found in ISO 5658-2 and IMO Resolution A.653(16) (1).

6.2 Instrumentation:

6.2.1 *Total Radiation Pyrometer*—This instrument shall be compensated for its temperature variation and shall have a sensitivity between the thermal wavelengths of 1 and 9 μm that is nominally constant and shall view a centrally located area on the radiant panel of about 150 by 300 mm. The instrument shall be rigidly mounted on the specimen support frame in such a manner that it will be directed at the radiant panel surface oriented for specimens in the vertical positions.

6.2.2 *Heat Fluxmeters*—It is desirable to have at least two fluxmeters for this test method. They shall be of the thermopile type with a sensitivity of approximately 10 mV at 50 kW/m² and capable of operation at three times this rating. One of these shall be retained as a laboratory reference standard. They shall have been calibrated to an accuracy of ±5 % or better. The time constant of these instruments shall not be more than 290 ms (corresponding to a time to reach 95 % of final output of not



FIG. 5 Rear View of Specimen Supported in Equipment Showing Specimen Clamp, Stack and Handle of Stack Thermocouple Assembly

more than 1 s). The target sensing the applied flux shall occupy an area not more than 4 by 4 mm and be located flush with and at the center of the water cooled 25 mm circular exposed metallic end of the fluxmeter. If fluxmeters of smaller diameter are to be used, these shall be inserted into a copper sleeve of 25 mm outside diameter in such a way that good thermal contact is maintained between the sleeve and water cooled fluxmeter body. The end of the sleeve and exposed surface of the fluxmeter shall lie in the same plane. Radiation shall not pass through any window before reaching the fluxmeter sensing surface.

6.2.3 *Timing Devices*, such as either a paper tape chronograph, as well as digital clock with second resolution, digital stopwatch with a memory for ten times, an audio tape recorder, a data acquisition/computer system, or an audio visual (VCR) instrument shall be provided to measure the times of ignition and flame front advancement with resolution to 1/10 s.

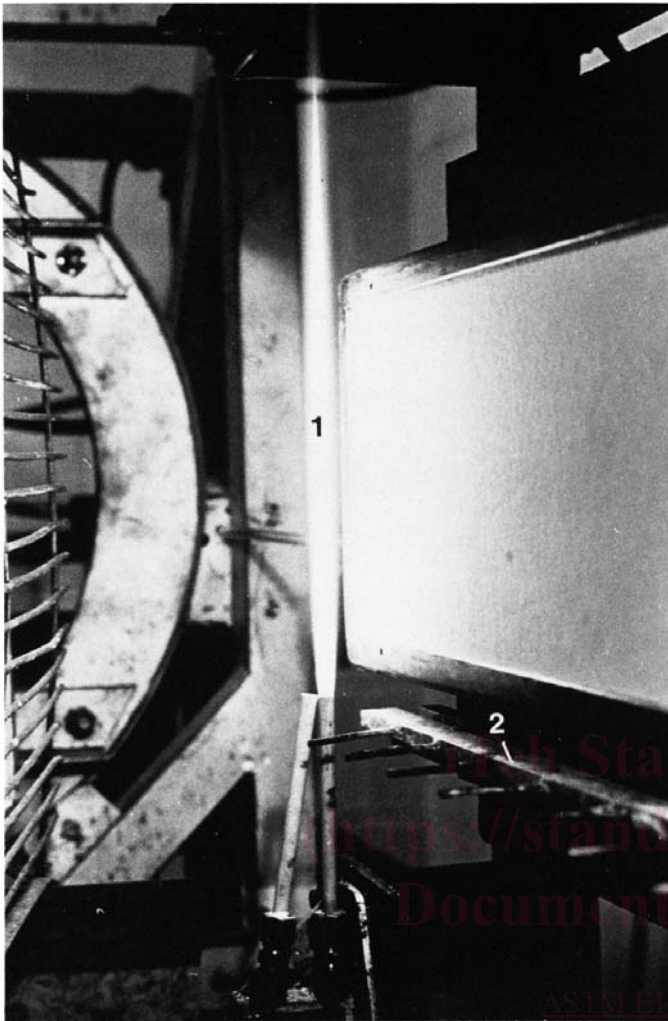

1—Pilot flame
2—Viewing rake

NOTE 1—Two burners are provided; only one for the non-contracting pilot is operating.

FIG. 6 Pilot Flame and Dummy Assembly

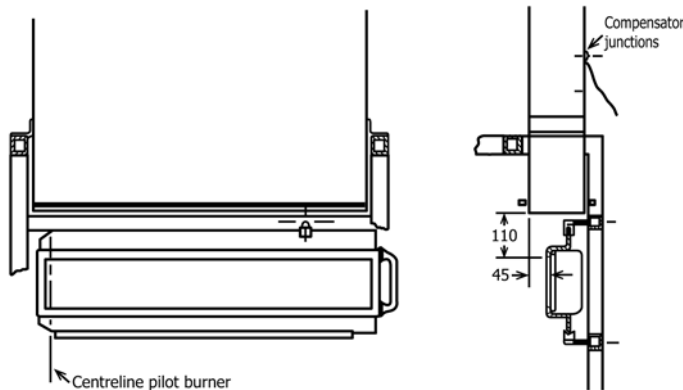

FIG. 7 Stack—Specimen Position Dimensions

6.2.4 *Recording Millivoltmeter*—A two-channel multirange recording millivoltmeter having at least 1 MΩ input resistance

shall be used to record signals from the fume stack thermocouples (see Fig. A1.3) and the output from the radiation pyrometer. The signal from the fume stack will in most instances be less than 15 mV. The sensitivity of the other channel shall be selected to require less than full scale deflection with the total radiation pyrometer or fluxmeter chosen. The effective operating temperature of the radiant panel will not normally exceed 935°C. Either the two-channel multi-range recording millivoltmeter or a digital millivoltmeter with a resolution of 10 μV or less shall be used for monitoring changes in operating conditions of the radiant panel.

6.3 *Space for Conducting Tests:*

6.3.1 *Test Area*—The dimensions of the test area shall be at least 45 m³ volume with a ceiling height of not less than 2.5 m.

6.3.2 *Fume Exhaust System*—An exhaust system shall be installed with a capacity for moving air and combustion products at a rate of 30 m³/min. The exhaust system shall be surrounded by a 1.3 by 1.3 m refractory-fiber fabric skirt hanging down to 1.7 ± 0.1 m from the floor of the room. The specimen support frame and radiant panel shall be located beneath this hood in such a way that essentially all combustion fumes are withdrawn from the room.

6.3.3 The apparatus shall be located with a clearance of at least 1-m separation between it and the walls of the test room. No combustible finish material of ceiling, floor, or walls shall be located within 2 m of the radiant heat source.

6.3.4 *Air Supply*—Access to an exterior supply of air, to replace that removed by the exhaust system, is required. This shall be arranged in such a way that the ambient temperature remains reasonably stable (for example, the air might be taken from an adjoining heated building).

6.3.5 *Room Draughts*—Measurements shall be made of air speeds near a dummy specimen in the vertical position while the fume exhaust system is operating but the radiant panel and its air supply are turned off. The air flow shall not exceed 0.2 m/s in any direction at a distance of 100 mm perpendicular to the lower edge at midlength of the specimen.

7. Hazards

7.1 Take the following safety precautions:

7.1.1 Safeguards shall be installed in the panel fuel supply to guard against a gas-air fuel explosion in the test chamber. The safeguards shall include, but are not limited to, one or more of the following: a gas feed cutoff activated when the air supply fails; a fire sensor directed at the panel surface to interrupt gas supply if the panel flame is extinguished; or other suitable and approved device. Manual reset is a requirement of any safeguard system used.

7.1.2 The exhaust system shall be so designed that the laboratory environment is protected from smoke and gas. The operator shall be instructed to minimize his exposure to combustion products by following sound safety and industrial hygiene practices, for example, ensure that the exhaust system is working properly, wear appropriate clothing including gloves, wear breathing apparatus when hazardous fumes are expected.

8. Test Specimens

8.1 The samples selected for testing shall be representative of the product as it is intended for use.

8.2 *Specimen Size*—The specimen shall be 155 + 0, - 5 mm wide by 800 + 0, - 5 mm long, and shall be representative of the product.

8.3 *Specimen Thickness*—Materials and composites of normal thickness 50 mm or less shall be tested using their full thickness. For materials and composites of normal thickness greater than 50 mm, obtain the requisite specimens by cutting away the unexposed face to reduce the thickness to 50 + 3, - 0 mm.

8.4 *Number Required*—Test three specimens for each different exposed surface and specimen orientation of the product evaluated.

8.5 *Composites*—Assemblies shall be as specified in 8.3. However, where thin materials or composites are used, it is possible that the presence of an air gap or the nature of any underlying construction, or both, significantly affects the flammability characteristics of the exposed surface. Care shall be taken to ensure that the test result obtained on any assembly is relevant to its use in practice. For comparison of the relative performance of surface treatments without consideration of the particular backing to which they are likely to be applied, they shall be tested on 10 to 21-mm marine board backing.

9. Calibration of Apparatus

9.1 Perform mechanical, electrical, and thermal calibrations as described in Annex A1. Perform these adjustments and calibrations following initial installation of the apparatus and at other times as the need arises.

9.2 *Monthly Verification*—In a continuing program of tests, the flux distribution shall be determined not less than once a month. When the time interval between tests is greater than one month, the flux distribution shall be determined at the start of the test series.

9.3 *Daily Verification*—Perform the following tests on a daily basis.

9.3.1 *Adjustment of the Pilot Burner*—Adjust the acetylene and air supply to provide a flame length of about 230 mm (see Fig. 8). When this has been done, the flame length as viewed in a darkened laboratory will be seen to extend about 40 mm above the upper retaining flange of the specimen holder. Adjust the space between the burner and the specimen while the radiant source is operating using softwood splines of 3-mm thickness and of 10 and 12-mm width. When these splines are moved along the flame length between the pilot burner flame and a dummy specimen surface during a 2-s exposure, the 10-mm spline shall not be charred but the 12-mm spline shall show char. With the specimen in the vertical position, the charring of the 12-mm spline shall occur over a vertical distance of at least 40 mm from the upper exposed edge of the specimen.

9.3.2 Clean the stack-gas thermocouples by light brushing at least daily. When materials producing heavy soot clouds are tested it is likely that such cleaning will be required even more frequently. Also individually check these thermocouples for electrical continuity to ensure the existence of a useful thermojunction. Following daily cleaning of the parallel connected stack-gas thermocouples, check both the thermocouples and the compensating junction to verify that the resistance between them and the stack metal is in excess of $10^6 \Omega$.

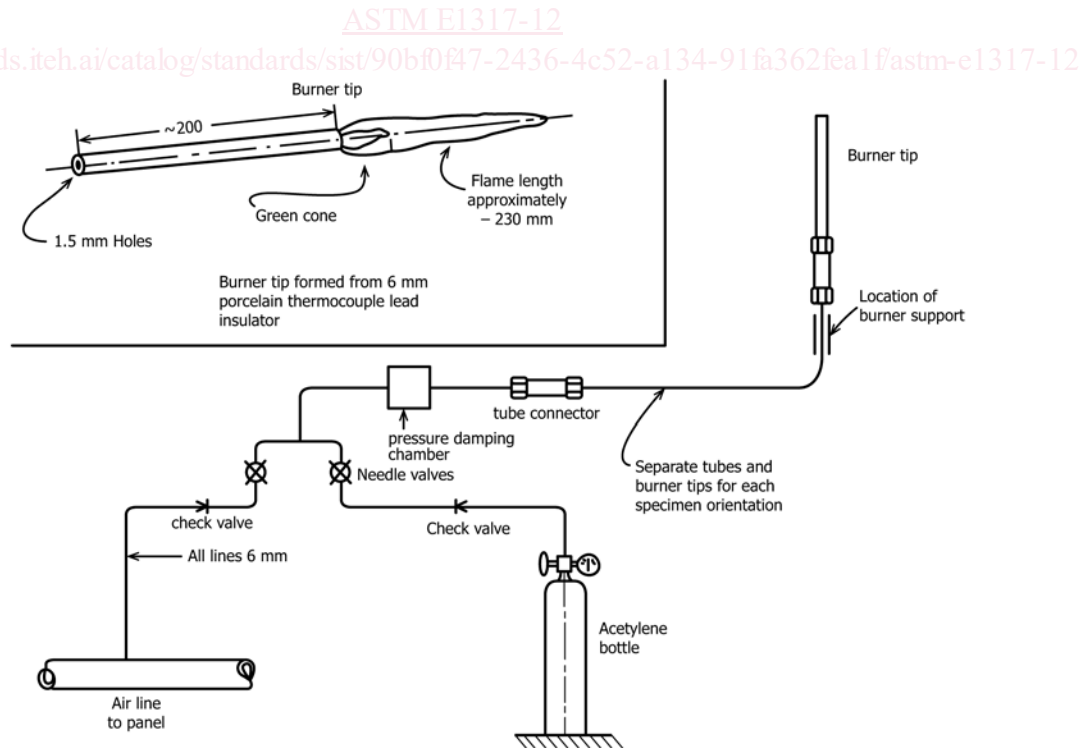

FIG. 8 Pilot Burner Details and Connections