**Technical product documentation
(TPD) — General principles of
representation —**

**Part 2:
Basic conventions for lines**

*Documentation technique de produits (TPD) — Principes généraux de
représentation —
Partie 2: Conventions de base pour les traits*

[ISO 128-2:2022](https://standards.iteh.ai/catalog/standards/sist/ed38e2d0-844f-4eb5-97a9-8770b7a9acd6/iso-128-2-2022)

<https://standards.iteh.ai/catalog/standards/sist/ed38e2d0-844f-4eb5-97a9-8770b7a9acd6/iso-128-2-2022>



iTeh STANDARD PREVIEW
(standards.iteh.ai)

ISO 128-2:2022

<https://standards.iteh.ai/catalog/standards/sist/ed38e2d0-844f-4eb5-97a9-8770b7a9acd6/iso-128-2-2022>



COPYRIGHT PROTECTED DOCUMENT

© ISO 2022

All rights reserved. Unless otherwise specified, or required in the context of its implementation, no part of this publication may be reproduced or utilized otherwise in any form or by any means, electronic or mechanical, including photocopying, or posting on the internet or an intranet, without prior written permission. Permission can be requested from either ISO at the address below or ISO's member body in the country of the requester.

ISO copyright office
CP 401 • Ch. de Blandonnet 8
CH-1214 Vernier, Geneva
Phone: +41 22 749 01 11
Email: copyright@iso.org
Website: www.iso.org

Published in Switzerland

Contents

	Page
Foreword.....	iv
Introduction.....	v
1 Scope	1
2 Normative references	1
3 Terms and definitions	2
4 Types of lines	3
4.1 General.....	3
4.2 Basic types.....	3
4.3 Line subtypes.....	4
4.4 Variations of the basic types of lines.....	4
4.5 Combinations of lines with the same length.....	4
4.5.1 Arrangement of two or more lines parallel to each other.....	4
4.5.2 Arrangement of two different types of lines.....	5
4.5.3 Arrangement of two continuous lines parallel to each other with regularly recurring connecting elements between them.....	5
4.5.4 Arrangement of regularly recurring geometric pictorial elements in association with continuous lines.....	5
5 Line dimensions	6
5.1 Line width.....	6
5.2 Deviation in line width.....	6
5.3 Configuration of lines.....	6
6 Draughting of lines	7
6.1 Spacing.....	7
6.2 Junctions.....	7
6.2.1 Types.....	7
6.2.2 Representation.....	9
6.3 Location of a second line.....	10
6.4 Hierarchy of overlapping lines.....	10
7 Colours	11
8 Designation	11
9 Basic conventions and applications for leader lines and reference lines	11
9.1 Presentation of leader lines.....	11
9.2 Representation of reference lines.....	14
9.3 Indication of instructions.....	15
Annex A (informative) Preparation of lines by CAD systems	17
Annex B (normative) Lines in construction technical drawings	30
Annex C (informative) Examples of application in construction technical drawings	33
Annex D (normative) Types of lines and their application in mechanical engineering technical drawings	39
Annex E (informative) Examples of application in mechanical engineering technical drawings	43
Annex F (normative) Types of lines and their application on shipbuilding technical drawings	55
Annex G (informative) Application examples of the different types of lines on shipbuilding technical drawings	57
Bibliography	68

Foreword

ISO (the International Organization for Standardization) is a worldwide federation of national standards bodies (ISO member bodies). The work of preparing International Standards is normally carried out through ISO technical committees. Each member body interested in a subject for which a technical committee has been established has the right to be represented on that committee. International organizations, governmental and non-governmental, in liaison with ISO, also take part in the work. ISO collaborates closely with the International Electrotechnical Commission (IEC) on all matters of electrotechnical standardization.

The procedures used to develop this document and those intended for its further maintenance are described in the ISO/IEC Directives, Part 1. In particular, the different approval criteria needed for the different types of ISO documents should be noted. This document was drafted in accordance with the editorial rules of the ISO/IEC Directives, Part 2 (see www.iso.org/directives).

Attention is drawn to the possibility that some of the elements of this document may be the subject of patent rights. ISO shall not be held responsible for identifying any or all such patent rights. Details of any patent rights identified during the development of the document will be in the Introduction and/or on the ISO list of patent declarations received (see www.iso.org/patents).

Any trade name used in this document is information given for the convenience of users and does not constitute an endorsement.

For an explanation of the voluntary nature of standards, the meaning of ISO specific terms and expressions related to conformity assessment, as well as information about ISO's adherence to the World Trade Organization (WTO) principles in the Technical Barriers to Trade (TBT), see www.iso.org/iso/foreword.html.

This document was prepared by Technical Committee ISO/TC 10, *Technical product documentation*, in collaboration with the European Committee for Standardization (CEN) Technical Committee CEN/SS F01, *Technical drawings*, in accordance with the Agreement on technical cooperation between ISO and CEN (Vienna Agreement).

This second edition cancels and replaces the first edition (ISO 128-2:2020), of which it constitutes a minor revision. The changes are as follows:

- the term “line element” changed to “graphical basic element” throughout;
- in [Annex C, Table C.1](#), the right-hand cell in the header has been changed from “Example” to “Figure no.” to be consistent with [Table E.1](#);
- in [Annex D, Table D.1](#), item 04.2.1, duplicate text removed;
- in [Annex G, Table G.1](#), the third header cell from the left has been changed from “Example” to “Application” to be consistent with [Table C.1](#) and [Table E.1](#);
- in [Annex E, Table E.1](#) and in [Annex G, Table G.1](#), the right-hand cell in the header has been changed from “Figure” to “Example” to be consistent with the rest of the document;
- minor editorial changes.

A list of all parts in the ISO 128 series can be found on the ISO website.

Any feedback or questions on this document should be directed to the user's national standards body. A complete listing of these bodies can be found at www.iso.org/members.html.

Introduction

This document contains generally applicable rules for the presentation of lines in all kinds of technical product documentation.

All figures in this document have been drawn in first-angle projection. It should be understood that third-angle projection or other methods could have been used equally well without prejudice to the principles established.

The application of lines within drawings of special technical fields varies considerably. Therefore, rules of application specific to technical fields are given in [Annexes B](#) to [G](#).

[Annex A](#) provides information for the calculation of the most important basic types of non-continuous lines according to types of lines and their graphical basic elements.

iTeh STANDARD PREVIEW
(standards.iteh.ai)

ISO 128-2:2022

<https://standards.iteh.ai/catalog/standards/sist/ed38e2d0-844f-4eb5-97a9-8770b7a9acd6/iso-128-2-2022>

Technical product documentation (TPD) — General principles of representation —

Part 2: Basic conventions for lines

1 Scope

This document establishes the types of lines used in technical drawings (e.g. diagrams, plans or maps), their designations and their configurations, as well as general rules for the draughting of lines. In addition, this document specifies general rules for the representation of leader and reference lines and their components as well as for the arrangement of instructions on or at leader lines in technical documents. Annexes have been provided for specific information on mechanical, construction and shipbuilding technical drawings.

For the purposes of this document the term “technical drawing” is interpreted in the broadest possible sense, encompassing the total package of documentation specifying the product (workpiece, subassembly, assembly).

2 Normative references

The following documents are referred to in the text in such a way that some or all of their content constitutes requirements of this document. For dated references, only the edition cited applies. For undated references, the latest edition of the referenced document (including any amendments) applies.

ISO 128-3, *Technical product documentation (TPD) — General principles of representation — Part 3: Views, sections and cuts*

ISO 128-15, *Technical product documentation (TPD) — General principles of presentation — Part 15: Presentation of shipbuilding drawings*

ISO 129-1, *Technical product documentation (TPD) — Presentation of dimensions and tolerances — Part 1: General principles*

ISO 129-5, *Technical product documentation — Indication of dimensions and tolerances — Part 5: Dimensioning of structural metal work*

ISO 1101, *Geometrical product specifications (GPS) — Geometrical tolerancing — Tolerances of form, orientation, location and run-out*

ISO 2203, *Technical drawings — Conventional representation of gears*

ISO 2538-2, *Geometrical product specifications (GPS) — Wedges — Part 2: Dimensioning and tolerancing*

ISO 2553, *Welding and allied processes — Symbolic representation on drawings — Welded joints*

ISO 3040, *Geometrical product specifications (GPS) — Dimensioning and tolerancing — Cones*

ISO 3766, *Construction drawings — Simplified representation of concrete reinforcement*

ISO 4463-1, *Measurement methods for building — Setting-out and measurement — Part 1: Planning and organization, measuring procedures, acceptance criteria*

ISO 4463-3, *Measurement methods for building — Setting-out and measurement — Part 3: Check-lists for the procurement of surveys and measurement services*

ISO 5261, *Technical drawings — Simplified representation of bars and profile sections*

ISO 5455, *Technical drawings — Scales*

ISO 5456-4, *Technical drawings — Projection methods — Part 4: Central projection*

ISO 5459, *Geometrical product specifications (GPS) — Geometrical tolerancing — Datums and datum systems*

ISO 6410-1, *Technical drawings — Screw threads and threaded parts — Part 1: General conventions*

ISO 6428, *Technical drawings — Requirements for microcopying*

ISO 7437, *Technical drawings — Construction drawings — General rules for execution of production drawings for prefabricated structural components*

ISO 7519, *Technical drawings — Construction drawings — General principles of presentation for general arrangement and assembly drawings*

ISO 8560, *Technical drawings — Construction drawings — Representation of modular sizes, lines and grids*

ISO 10110-1, *Optics and photonics — Preparation of drawings for optical elements and systems — Part 1: General*

ISO 10135, *Geometrical product specifications (GPS) — Drawing indications for moulded parts in technical product documentation (TPD)*

ISO 10209, *Technical product documentation — Vocabulary — Terms relating to technical drawings, product definition and related documentation*

ISO 11091, *Construction drawings — Landscape drawing practice*

ISO 12671, *Thermal spraying — Thermally sprayed coatings — Symbolic representation on drawings*

ISO 15785, *Technical drawings — Symbolic presentation and indication of adhesive, fold and pressed joints*

ISO 15787, *Technical product documentation — Heat-treated ferrous parts — Presentation and indications*

ISO 16792, *Technical product documentation — Digital product definition data practices*

3 Terms and definitions

For the purposes of this document, the terms and definitions given in ISO 10209 and the following apply.

ISO and IEC maintain terminology databases for use in standardization at the following addresses:

- ISO Online browsing platform: available at <https://www.iso.org/obp>
- IEC Electropedia: available at <https://www.electropedia.org/>

3.1

graphical basic element

continuous graphical object with rounded or squared end shape which is represented in any way (e.g. straight, curved), which has a length and a width

Note 1 to entry: See [Figure A.1](#).







3.2

dot

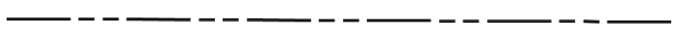
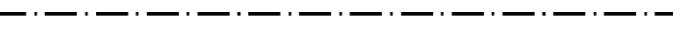
graphical basic element ([3.1](#)) having a length equal to the width, d

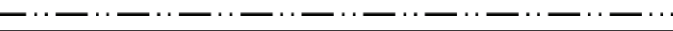
Note 1 to entry: See [Figure A.2](#).



Table 1 (continued)

No.	Representation	Description
09		Long-dashed double-short-dashed line
10		Dashed dotted line
11		Double-dashed dotted line
12		Dashed double-dotted line
13		Double-dashed double-dotted line
14		Dashed triplicate-dotted line
15		Double-dashed triplicate-dotted line

4.3 Line subtypes

The line subtypes are given in [Table 2](#).

Table 2 — Line subtypes



Subtype no. ^a	Representation	Description
.1		Narrow
.2		Wide
.3		Extra-wide

^a Line identification structure

4.4 Variations of the basic types of lines

The straight lines in [Table 1](#) and the line widths of [Table 2](#) can have variations as shown in [Table 3](#).

Table 3 — Line variations

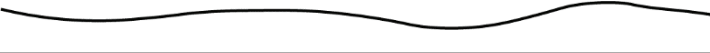
Representation	Description
	Uniform wavy continuous line
	Uniform spiral continuous line
	Uniform zigzag continuous line
	Freehand or freeform curve continuous line

NOTE This table contains only variations of the basic type of line no. 01. Variations of the basic types of no. 02 to no. 15 are possible and are presented in the same way.

4.5 Combinations of lines with the same length

4.5.1 Arrangement of two or more lines parallel to each other

For examples see [Figure 1](#).

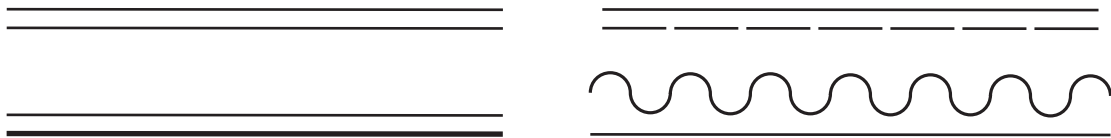

Figure 1 — Example of lines parallel to each other

4.5.2 Arrangement of two different types of lines

a) With different line widths superimposed. See Figure 2 a) and b) for examples.

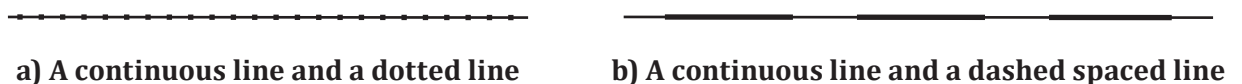

Figure 2 — Example of superimposed lines

b) Arranged next to each other. See Figure 3 for an example.



Figure 3 — Two continuous narrow lines either side of a wide dashed line

4.5.3 Arrangement of two continuous lines parallel to each other with regularly recurring connecting elements between them

See Figure 4 a) and b) for examples.



Figure 4 — Example of lines parallel to each other with regularly recurring connecting elements

4.5.4 Arrangement of regularly recurring geometric pictorial elements in association with continuous lines

a) Without interruption of a continuous line. See Figure 5 for examples.



Figure 5 — Without interruption of a continuous line

b) With interruption of a continuous line. See Figure 6 for examples.

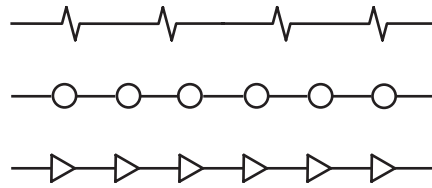

Figure 6 — With interruption of a continuous line

5 Line dimensions

5.1 Line width

The width, d , of all types of lines shall be one of the following depending on the type and size of the technical drawing. This series is based on a common ratio $1:\sqrt{2}$ ($\approx 1:1,4$).

0,13 mm; 0,18 mm; 0,25 mm; 0,35 mm; 0,5 mm; 0,7 mm; 1 mm; 1,4 mm; 2 mm.

The widths of extra-wide, wide and narrow lines are in the ratio 4:2:1.

The line width of any one line shall be constant throughout the whole line.

See Annexes B, D and F for information on line widths pertaining to construction, mechanical and shipbuilding technical drawings.

5.2 Deviation in line width

Line widths can deviate from those specified in 5.1 providing that it is possible to differentiate unambiguously between two adjacent lines with different widths. If technical drawing equipment which produces constant line width is used, the deviation in line width between two such lines shall not be greater than $\pm 0,1d$.

5.3 Configuration of lines

For the preparation of technical drawings, the lengths of graphical basic elements should conform to those of Table 4.

Table 4 — Lengths of graphical basic elements

Drawing element	Line type no.	Length
Dot	04 to 07 and 10 to 15	$\leq d$
Gap	02 and 04 to 15	$3d$
Short dash	08 and 09	$6d$
Dash	02, 03 and 10 to 15	$12d$
Long dash	04 to 06, 08 and 09	$\approx 24d$
Space	03	$18d$

NOTE The lengths shown in this table are valid for graphical basic elements with semi-circular and squared ends. In the case of graphical basic elements with semi-circular ends, the length of the graphical basic element corresponds to the distance covered by a technical pen (with a tubular tip and using India ink) from the origin up to the end of the graphical basic element. The total length of such a graphical basic element is the sum of the length shown in this table, plus d .

Formulae for the calculation of some of the basic types of lines and graphical basic elements are given in [Annex A](#). The formulae are intended to facilitate the preparation of technical drawings using computer-aided design (CAD) systems.

6 Draughting of lines

6.1 Spacing

The minimum space between parallel lines should not be less than 0,7 mm.

In certain cases when computer-aided technical drawing techniques are used, the spacing of lines on the technical drawing does not represent the actual spacing, for example for the representation of screw threads. This has to be considered when data sets are established, for example for the operation of machine tools.

6.2 Junctions

6.2.1 Types

The basic types of lines, no. 02 to no. 06 and no. 08 to no. 15, should meet at a dash to avoid ambiguity; see [Figures 7](#) to [12](#).

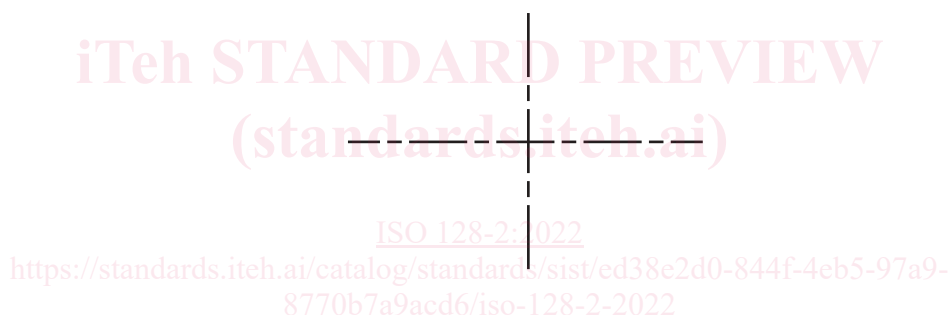

Figure 7 — Long-dashed short-dashed lines intersecting as a cross

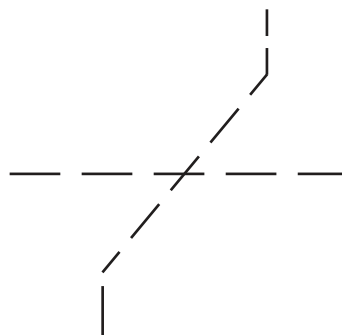

Figure 8 — Dashed lines intersecting as a cross

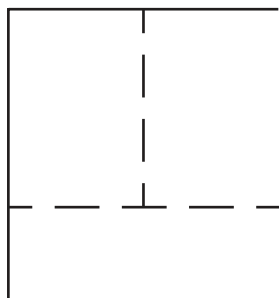

Figure 9 — Dashed lines intersecting as a partial cross

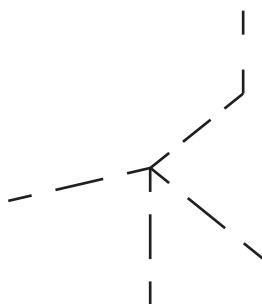
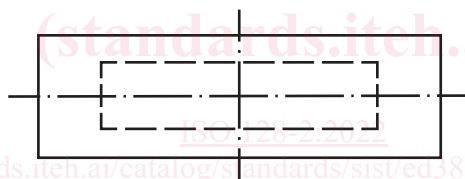

Figure 10 — Four dashed lines meeting at an intersection



<https://standards.iteh.ai/catalog/standards/sist/cd58e2d0-844f-4eb5-97a9-8770b7a9acd6/iso-128-2-2022>

Figure 11 — Dash dotted lines intersecting as a cross and dashed lines meeting at corners

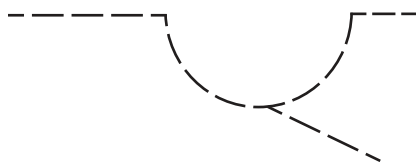

Figure 12 — Dashed lines meeting at corners and at intersection

Lines of basic type no. 07 should meet at a dot to avoid ambiguity, see [Figure 13](#).

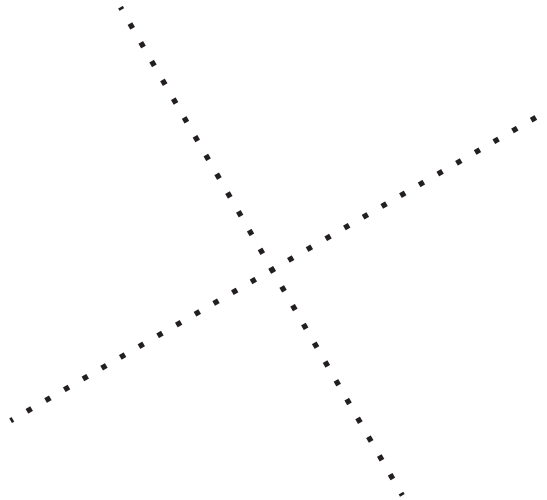

Figure 13 — Dotted lines intersecting at a dot

6.2.2 Representation

Techniques for applying the recommendations of [6.2.1](#) are to start the lines at the junction (see [Figure 14](#)) or by using a complete, or partial, cross or Y (see [Figures 15](#) and [16](#)).

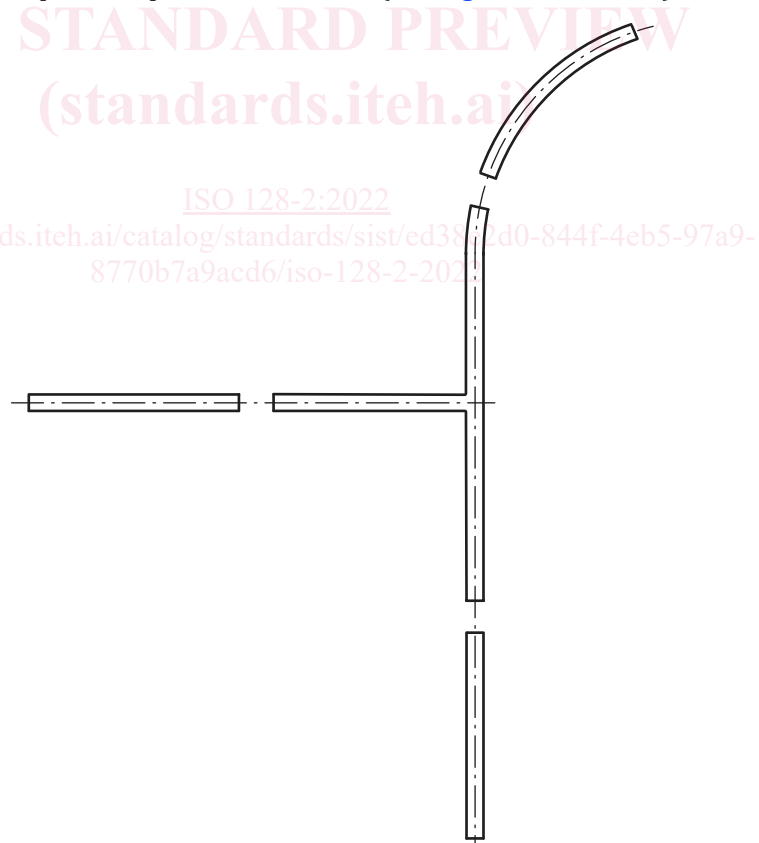

Figure 14 — Partial cross intersection