



Designation: **C1433—10 C1433 – 13**

# Standard Specification for Precast Reinforced Concrete Monolithic Box Sections for Culverts, Storm Drains, and Sewers<sup>1</sup>

This standard is issued under the fixed designation C1433; the number immediately following the designation indicates the year of original adoption or, in the case of revision, the year of last revision. A number in parentheses indicates the year of last reapproval. A superscript epsilon ( $\epsilon$ ) indicates an editorial change since the last revision or reapproval.

## 1. Scope

1.1 This specification covers single-cell precast reinforced concrete box sections cast monolithically and intended to be used for the construction of culverts and for the conveyance of storm water industrial wastes and sewage.

1.2 This specification is the companion to SI Specification C1433M; therefore, no SI equivalents are shown in this specification.

NOTE 1—This specification is primarily a manufacturing and purchasing specification. However, standard designs are included and the criteria used to develop these designs are given in **Appendix X1**. The successful performance of this product depends upon the proper selection of the box section, bedding, backfill, and care that the installation conforms to the construction specifications. The purchaser of the precast reinforced concrete box sections specified herein is cautioned that proper correlation of the loading conditions and the field requirements with the box section specified, and provision for inspection at the construction site, are required.

## 2. Referenced Documents

### 2.1 ASTM Standards:<sup>2</sup>

- A82/A82M Specification for Steel Wire, Plain, for Concrete Reinforcement
- A185/A185M Specification for Steel Welded Wire Reinforcement, Plain, for Concrete
- A496/A496M Specification for Steel Wire, Deformed, for Concrete Reinforcement
- A497/A497M Specification for Steel Welded Wire Reinforcement, Deformed, for Concrete
- A615/A615M Specification for Deformed and Plain Carbon-Steel Bars for Concrete Reinforcement
- C31/C31M Practice for Making and Curing Concrete Test Specimens in the Field
- C33 Specification for Concrete Aggregates
- C39/C39M Test Method for Compressive Strength of Cylindrical Concrete Specimens
- C150 Specification for Portland Cement
- C309 Specification for Liquid Membrane-Forming Compounds for Curing Concrete
- C497 Test Methods for Concrete Pipe, Manhole Sections, or Tile
- C595 Specification for Blended Hydraulic Cements
- C618 Specification for Coal Fly Ash and Raw or Calcined Natural Pozzolan for Use in Concrete
- C822 Terminology Relating to Concrete Pipe and Related Products
- C989 Specification for Slag Cement for Use in Concrete and Mortars
- C1116 Specification for Fiber-Reinforced Concrete and Shotcrete

### 2.2 AASHTO Standard:<sup>3</sup>

Standard Specifications for Highway Bridges

## 3. Terminology

3.1 *Definitions*—For definitions of terms relating to concrete pipe, see Terminology **C822**.

## 4. Types

4.1 Precast reinforced concrete box sections manufactured in accordance with this specification shall be one of two types identified in **Table 1** and **Table 2**, and shall be designated by type, span, rise, and design earth cover.

<sup>1</sup> This specification is under the jurisdiction of ASTM Committee **C13** on Concrete Pipe and is the direct responsibility of Subcommittee **C13.07** on Acceptance Specifications and Precast Concrete Box Sections.

Current edition approved March 15, 2010; Feb. 15, 2013. Published March 2010; March 2013. Originally approved in 1999. Last previous edition approved in 2008; 2010 as **C1433—08; C1433 – 10**. DOI: 10.1520/C1433-10; 10.1520/C1433-13.

<sup>2</sup> For referenced ASTM standards, visit the ASTM website, [www.astm.org](http://www.astm.org), or contact ASTM Customer Service at [service@astm.org](mailto:service@astm.org). For *Annual Book of ASTM Standards* volume information, refer to the standard's Document Summary page on the ASTM website.

<sup>3</sup> Available from American Association of State Highway and Transportation Officials (AASHTO), 444 N. Capitol St., NW, Suite 249, Washington, DC 20001.

## 5. Basis of Acceptance

5.1 Acceptability of the box sections produced in accordance with Section 7 shall be determined by the results of the concrete compressive strength tests described in Section 10, by the material requirements described in Section 6, and by inspection of the finished box sections.

5.2 Box sections shall be considered ready for acceptance when they conform to the requirements of this specification.

## 6. Material

6.1 *Reinforced Concrete*—The reinforced concrete shall consist of cementitious materials, mineral aggregates and water, in which steel has been embedded in such a manner that the steel and concrete act together.

6.2 *Cementitious Materials:*

6.2.1 *Cement*—Cement shall conform to the requirements for portland cement of Specification C150 or shall be portland blast-furnace slag cement or portland-pozzolan cement conforming to the requirements of Specification C595, except that the pozzolan constituent in the Type IP portland-pozzolan cement shall be fly ash.

6.2.2 *Fly Ash*—Fly ash shall conform to the requirements of Specification C618, Class F or Class C.

6.2.3 *Ground Granulated Blast-Furnace Slag (GGBFS)*—GGBFS shall conform to the requirements of Grade 100 or 120 of Specification C989.

6.2.4 *Allowable Combinations of Cementitious Materials*—The combination of cementitious materials used in concrete shall be one of the following:

6.2.4.1 Portland cement only,

6.2.4.2 Portland blast furnace slag cement only,

6.2.4.3 Slag modified portland cement only,

6.2.4.4 Portland pozzolan cement only,

6.2.4.5 A combination of portland cement and fly ash.

6.2.4.6 A combination of portland cement and ground granulated blast-furnace slag,

6.2.4.7 A combination of portland cement, ground granulated blast-furnace slag (not to exceed 25 % of the total cementitious weight), and fly ash (not to exceed 25 % of the total cementitious weight).

6.3 *Aggregates*—Aggregates shall conform to Specification C33, except that the requirements for gradation shall not apply.

6.4 *Admixtures and Blends*—Admixtures and blends shall be allowed to be used with the approval of the purchaser.

6.5 *Steel Reinforcement*—Reinforcement shall consist of welded wire reinforcement conforming to Specifications A185/A185M or A497/A497M. Circumferential reinforcement areas in Tables 1 and 2 are based solely on the use of welded wire reinforcement, refer to 11.6 if alternate steel designs utilizing steel bars, Grade 60, in conjunction with or in lieu of welded wire reinforcement are to be submitted for the owner's approval. Longitudinal distribution reinforcement shall be allowed to consist of welded wire reinforcement or deformed billet-steel bars conforming to Specification A615/A615M, Grade 60.

6.6 *Synthetic Fibers*—The manufacturer is not prohibited from using collated fibrillated virgin polypropylene fibers in precast box culverts as a nonstructural manufacturing material. Only Type III synthetic fibers designed and manufactured specifically for use in concrete and conforming to the requirements of Specification C1116 shall be accepted.

## 7. Design

7.1 *Design Tables*—The box section dimensions, compressive strength of the concrete, and reinforcement details shall be as prescribed in Table 1 or Table 2 and Figs. 1-4, subject to the provisions of Section 11. Table 1 sections are designed for combined earth dead load and AASHTO HS20 live load conditions. Table 2 sections are designed for combined earth dead load and interstate live load conditions when the interstate live loading exceeds the HS20 live loading. Criteria used to develop Tables 1 and 2 are given in Appendix XI.

NOTE 2—The tabular designs in this specification were prepared according to AASHTO Standard Specifications for Highway Bridges, 1997 Edition.

7.2 *Modified and Special Designs for Monolithic Structures*—The manufacturer shall request approval by the purchaser of modified designs that differ from the designs in Section 7.1; or special designs for sizes and loads other than those shown in Tables 1 and 2. When spans are required that exceed those prescribed in Table 1 or Table 2, the design shall be based on the criteria given in Appendix XI. In addition, the span shall be designed to have adequate stiffness to limit deflection as given in Section 8.9 of AASHTO Standard Specification for Highway Bridges (latest edition).

NOTE 3—Construction procedures, such as heavy equipment movement or stockpiling of material over or adjacent to a box structure, can induce higher loads than those used for the structure's final design. These construction and surcharge loads are approved as long as the final steel areas in the box are larger than those the box will experience in the final installation condition. The design engineer should take into consideration the potential for higher loads induced by construction procedures in determining the final design of the box structure.

7.3 *Placement of Reinforcement*—*Reinforcement*—The cover of concrete over the circumferential reinforcement shall be 1 in., subject to the provisions of Section 11. The inside circumferential reinforcement shall extend into the tongue portion of the joint and the outside circumferential reinforcement shall extend into the groove portion of the joint. The clear distance of the end

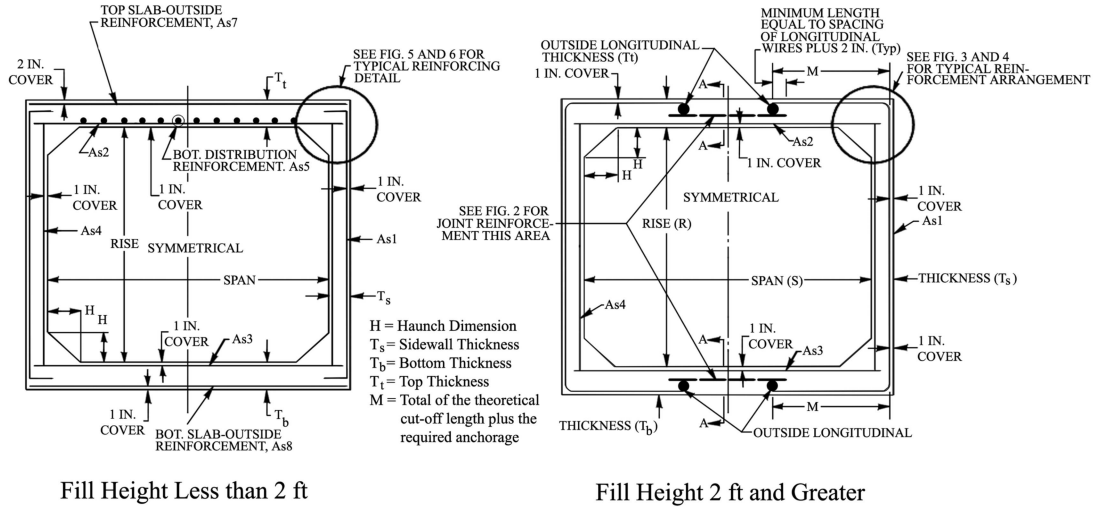

FIG. 1 Typical Box Sections

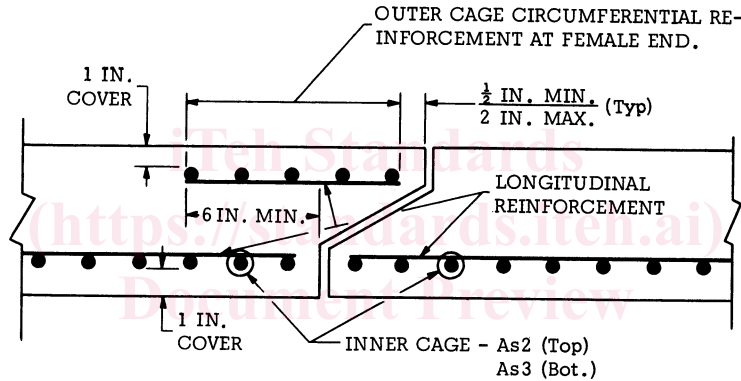

FIG. 2 Section A-A Top and Bottom Slab Joint Reinforcement

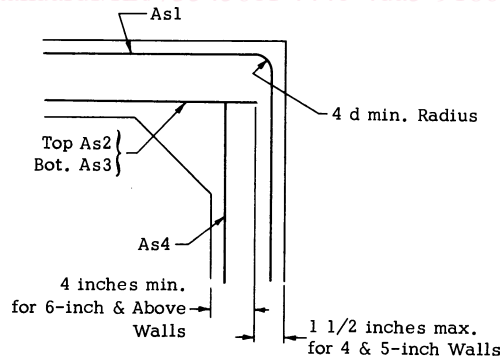

FIG. 3 Detail Inner Reinforcement

circumferential wires shall be not less than 1/2 in. nor more than 2 in. from the ends of the box section. Reinforcement shall be assembled utilizing any combination of single or multiple layers of welded-wire reinforcement. Multiple layers shall not be separated by more than the thickness of one longitudinal wire plus 1/4 in. The multiple layers shall be fastened together to form a single cage. All other specification requirements such as laps, welds, and tolerances of placement in the wall of the box section shall apply to this method of fabricating a reinforcement cage. A common reinforcement unit may be utilized for both As<sub>s2</sub> or (or As<sub>s3</sub>) and As<sub>s4</sub>, and also for both As<sub>s7</sub> (or As<sub>s8</sub>) and As<sub>s1</sub>, with the largest area requirement governing, bending the reinforcement at the corners and waiving the extension requirements of Fig. 3 (see Fig. 4). When a single cage of multiple circumferential steel areas is used for As<sub>s2</sub> (or As<sub>s3</sub>) and As<sub>s4</sub> reinforcement, the slab or wall requiring the larger steel area shall have this additional circumferential steel extending for the full length of the slab or wall. The welded-wire reinforcement shall be composed of

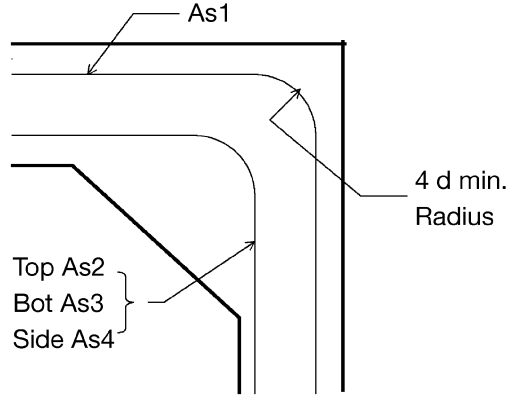

FIG. 4 Detail Option (see Fig. 3)

circumferential and longitudinal wires meeting the spacing requirements of 7.4 and shall contain sufficient longitudinal wires extending through the box section to maintain the shape and position of reinforcement. Longitudinal distribution reinforcement may be welded-wire reinforcement or deformed billet-steel bars and shall meet the spacing requirements of 7.4. The ends of the longitudinal distribution reinforcement shall not be more than 2 in. from the ends of the box section. The exposure of the ends of longitudinals, stirrups, and spacers used to position the reinforcement shall not be a cause for rejection.

7.4 Laps, Welds, and Spacing—Splices in the circumferential reinforcement shall be made by lapping. The overlap measured between the outermost longitudinal wires of each reinforcement sheet shall not be less than the spacing of the longitudinal wires plus 2 in. but not less than 10 in. If  $A_{s1}$  is extended to the middle of either slab and connected, welded splices are not prohibited in the connection. When used,  $A_{s7}$  and  $A_{s8}$  shall be lapped with  $A_{s1}$  as shown in Fig. 5 or Fig. 6 (see also Fig. 7 and Fig. 8). If welds are made to circumferential reinforcement, they shall be made only to selected circumferential wires that are not less than 18 in. apart along the longitudinal axis of the box section. Also, when spacers are welded to circumferential wires, they shall be welded only to these selected circumferential wires. There shall be no welding to other circumferential wires, except it is not prohibited for  $A_{s4}$  to be lapped and welded at any location or connected by welding at the corners to  $A_{s2}$  and  $A_{s3}$ . No welds shall be made to  $A_{s2}$  or  $A_{s3}$  circumferential wires in the middle third of the span. (See Fig. 9 for welding restrictions.) When distribution reinforcement is to be fastened to a cage by welding, it shall be welded only to longitudinal wires and only near the ends of the box section. The spacing center to center of the circumferential wires shall not be less than 2 in. nor more than 4 in. The spacing center to center of the longitudinal wires shall not be more than 8 in. -13

8. Joints <https://standards.iteh.ai/catalog/standards/sist/735456bf-444e-4da5-9186-85734787d1db/astm-c1433-13>

8.1 The precast reinforced concrete box sections shall be produced with tongue and groove ends. The ends shall be of such design and the ends of the box sections so formed that the sections can be laid together to make a continuous line of box sections compatible with the permissible variations given in Section 11.

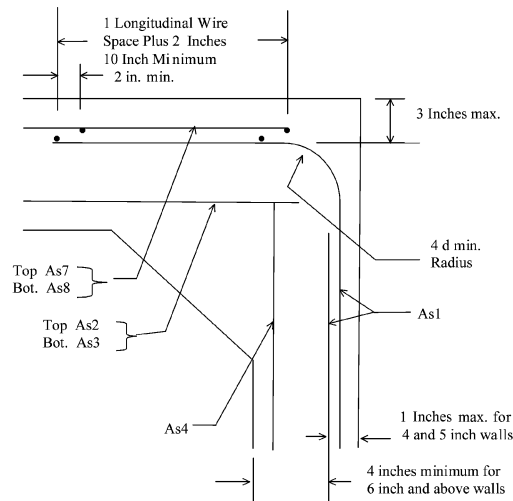

FIG. 5 Detailed Reinforcement Arrangement

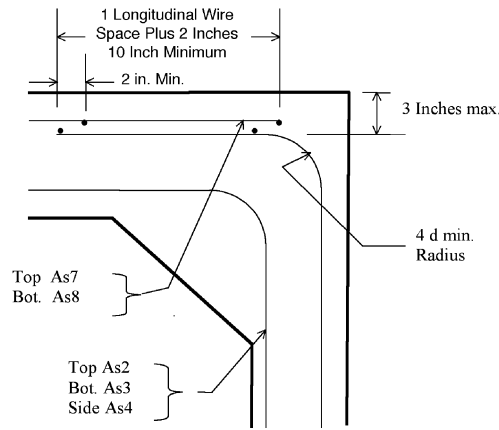

FIG. 6 Detail Option

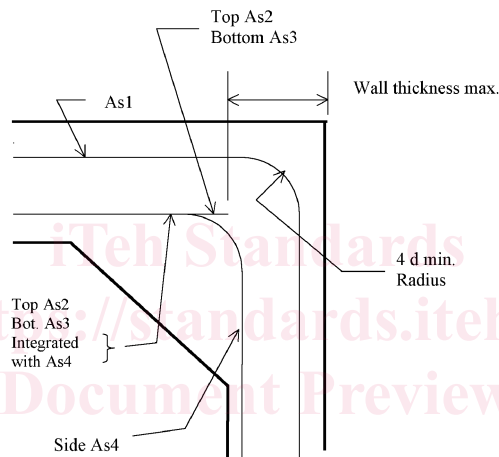

FIG. 7 Alternate Detail

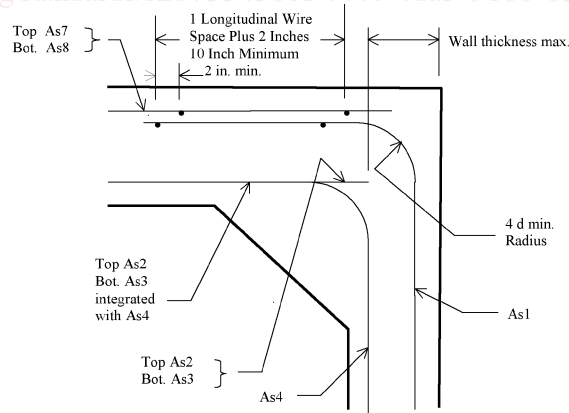

FIG. 8 Alternate Detail

8.2 Outer cage circumferential reinforcement as shown in Figs. 1 and 2 shall be placed in the top and bottom slabs at the groove portion of the joint when  $A_{s1}$  is not continuous over the span. The minimum area of such reinforcement in square inches per linear foot of box section length shall be the same as the areas specified for  $A_{s4}$  in Tables 1 and 2.

## 9. Manufacture

9.1 *Mixture*—The aggregates shall be sized, graded, proportioned, and mixed with such proportions of cementitious materials and water as will produce a homogeneous, thoroughly-mixed concrete mixture of such quality that the pipe will conform to the test

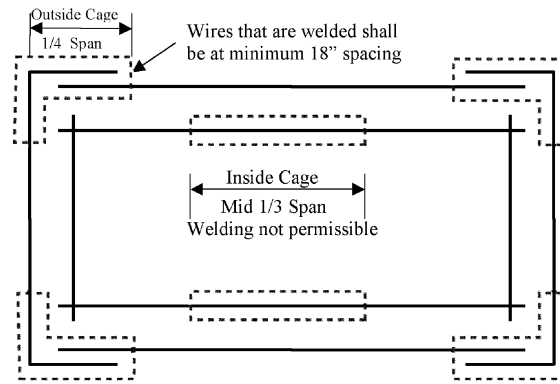

FIG. 9 Critical Zones of High Stress Where Welding is Restricted

and design requirements of this specification. All concrete shall have a water-cementitious materials ratio not exceeding 0.53 by weight. Cementitious materials shall be as specified in 6.2 and shall be added to the mix in a proportion not less than 470 lb/yd<sup>3</sup> unless mix designs with a lower cementitious materials content demonstrate that the quality and performance of the pipe meet the requirements of this specification.

9.2 *Curing*—The box sections shall be cured for a sufficient length of time so that the concrete will develop the specified compressive strength in 28 days or less. Any one of the following methods of curing or combinations thereof shall be allowed to be used:

9.2.1 *Steam Curing*—The box sections shall be allowed to be low pressure, steam-cured by a system that will maintain a moist atmosphere.

9.2.2 *Water Curing*—The box sections shall be allowed to be water-cured by any method that will keep the sections moist.

9.2.3 *Membrane Curing*—A sealing membrane conforming to the requirements of Specification C309 shall be allowed to be applied and shall be left intact until the required concrete compressive strength is attained. The concrete temperature at the time of application shall be within 10°F of the atmospheric temperature. All surfaces shall be kept moist prior to the application of the compounds and shall be damp when the compound is applied.

9.3 *Forms*—The forms used in manufacture shall be sufficiently rigid and accurate to maintain the box section dimensions within the permissible variations given in Section 11. All casting surfaces shall be of smooth nonporous material.

9.4 *Handling*—Handling devices or holes shall be permitted in each box section for the purpose of handling and laying.

## 10. Physical Requirements

10.1 *Type of Test Specimen*—Compression tests for determining concrete compressive strength shall be allowed to be made on either standard rodded concrete cylinders or concrete cylinders compacted and cured in like manner as the box sections, or on cores drilled from the box section.

### 10.2 *Compression Testing of Cylinders:*

10.2.1 Cylinders shall be obtained and tested for compressive strength in accordance with the provisions of Practice C31/C31M and Test Method C39/C39M, except that the cylinders may be prepared by methods comparable to those used to consolidate and cure the concrete in the actual box section manufactured. Cylindrical specimens of sizes other than 6 by 12 in. may be used provided all other requirements of Practice C31/C31M are met. If the concrete is of a consistency too stiff for compaction by rodding or internal vibration, the alternate method described in Section II of Test Methods C497 may be used. Cylinders shall be exposed to the same curing conditions as the manufactured box sections and shall remain with the sections until tested.

10.2.2 Prepare not less than three test cylinders from each concrete mix used within a group (one day's production) of box sections.

### 10.2.3 *Acceptability on the Basis of Cylinder Test Results:*

10.2.3.1 When the average compressive strength of all cylinders tested is equal to or greater than the design concrete strength, not more than 10 % of the cylinders tested have a compressive strength less than the design concrete strength, and no cylinder tested has a compressive strength less than 80 % of the design concrete strength, the lot shall be accepted.

10.2.3.2 When the compressive strength of the cylinders tested does not conform to the acceptance criteria stated in 10.2.3.1, the acceptability of the lot shall be determined in accordance with the provisions of 10.3.

### 10.3 *Compression Testing of Cores:*

10.3.1 Cores shall be obtained and tested for compressive strength in accordance with the provisions of Test Methods C497.

10.3.2 Three cores shall be cut from a section selected at random from each group of 15 box sections or fraction thereof, of a single size from each continuous production run.

### 10.3.3 Acceptability by Core Tests:

10.3.3.1 The compressive strength of the concrete in each group of box sections defined as the average of three cores taken at random from the subject group, is equal to or greater than 85 % of the required strength of the concrete with no one core less than 75 % of the required strength.

10.3.3.2 If the compressive strength of the three cores does not meet the requirements of 10.3.3.1, the sections from which the cores were taken shall be rejected. Two box sections from the remainder of the group shall be selected at random, and one core shall be taken from each. If both cores have a strength equal to or great than 85 % of the required strength of the concrete, the remainder of the group is acceptable. If the compressive strength of either of the two cores tested is less than 85 % of the required strength of the concrete, the remainder of the group of box sections shall be rejected or, at the option of the manufacturer, each box section of the entire group shall be cored and accepted individually, and any of these box sections that have cores with less than 85 % of the required strength of the concrete shall be rejected.

10.4 *Plugging Core Holes*—The core holes shall be plugged and sealed by the manufacturer in a manner such that the box section will meet all of the test requirements of this specification. Box sections so sealed shall be considered as satisfactory for use.

10.5 *Test Equipment*—Every manufacturer furnishing box sections under this specification shall furnish all facilities and personnel necessary to carry out the tests required.

## 11. Permissible Variations

11.1 *Internal Dimensions*—The internal dimension shall not vary more than 1 % from the design dimensions. The haunch dimensions shall not vary more than ¼ in. from the design dimensions.

11.2 *Slab and Wall Thickness*—The slab and wall thickness shall not be less than that shown in the design by more than 5 % or ⅜ in., whichever is greater. A thickness more than that required in the design shall not be a cause for rejection.

11.3 *Length of Opposite Surfaces*—Variations in laying lengths of two opposite surfaces of the box section shall not be more than ⅛ in./ft of internal span, with a maximum of ⅝ in. for all sizes through 7 ft internal span, and a maximum of ¾ in. for internal spans greater than 7 ft, except where beveled ends for laying of curves are specified by the purchaser.

11.4 *Length of Section*—The underrun in length of a section shall not be more than ⅛ in./ft of length with a maximum of ½ in. in any box section.

11.5 *Position of Reinforcement*—The maximum variation in the position of the reinforcement or 5-in. or less slab and wall thickness shall be ± ⅜ in., and for greater than 5-in. slab and wall thickness shall be ± ½ in. In no case, however, shall the cover over the reinforcement be less than ⅝ in., as measured to the internal surface or the external surface except the cover over the reinforcement for the external surface of the top slab for boxes with under 2 ft of cover shall not be less than 1⅝ in. The preceding minimum cover limitation does not apply at the mating surfaces of the joint.

11.6 *Area of Reinforcement*—The areas of steel reinforcement shall be the design steel areas as shown in **Tables 1 and 2**. Steel areas greater than those required shall not be cause for rejection. The permissible variation in diameter of any wire in finished reinforcement shall conform to the tolerances prescribed for the wire before fabrication by either Specification **A82/A82M** or **A496/A496M** as applicable. If steel bars (Grade 60) are used in lieu of welded wire reinforcement, the steel areas presented in **Tables 1 and 2** shall be increased to account for the difference in steel yield strength, steel spacing, concrete cover, and crack control between the welded wire reinforcement and steel bars.

11.7 *Haunch Dimensions*—The vertical and horizontal dimensions shall be equal to the side wall thickness. If haunches with other dimensions are used, a special reinforcement design for the actual dimensions shall be completed. In lieu of performing a special design, for the specific case where the actual haunch dimensions are larger than the standard dimensions and vertical and horizontal haunch dimensions are equal, the  $A_{s1}$  steel area shall be increased 1 % for every 5 % increase in the haunch dimension over that specified in **Table 1** or **Table 2** and  $A_{s2}$  and  $A_{s3}$  shall be reduced by an equal percentage.

## 12. Repairs

12.1 Box sections shall be repaired, if necessary, because of imperfections in manufacture or handling damage and will be acceptable if, in the opinion of the purchaser, the repaired box section conforms to the requirements of this specification.

## 13. Inspection

13.1 The quality of materials, the process of manufacture, and the finished box sections shall be subject to inspection by the purchaser.

## 14. Rejection

14.1 Box sections shall be subject to rejection on account of failure to conform to any of the specification requirements. Individual box sections shall be allowed to be rejected because of any of the following:

- 14.1.1 Fractures or cracks passing through the wall, except for a single end crack that does not exceed the depth of the joint,
- 14.1.2 Defects that indicate mixing and molding not in compliance with 9.1, or honeycombed or open texture that would adversely affect the function of the box sections,
- 14.1.3 Abnormalities in the ends of the box sections to the walls and center line of the box section, within the limits of variations given in Section 11, except where beveled ends are specified, and
- 14.1.4 Damaged ends, where such damage would prevent making a satisfactory joint.

**15. Marking**

15.1 The following information shall be legibly marked on each box section by indentation, waterproof paint, or other approved means:

- 15.1.1 Box section span, rise, table number, maximum and minimum design earth cover, and specification designation.
- 15.1.2 Date of manufacture, and
- 15.1.3 Name or trademark of the manufacturer.

15.2 Each section shall be clearly marked by indentation on either the inner or outer surface during the process of manufacture so that the location of the top will be evident immediately after the forms are stripped. In addition, the word “top” shall be lettered with waterproof paint on the inside top surface.

**TABLE 1 Design Requirements for Precast Concrete Box Sections Under Earth Dead and HS20 Live Load Conditions**

NOTE 1—Design earth covers and reinforcement areas are based on the weight of a column of earth over the width of the box section as defined in Appendix X1.

NOTE 2—Concrete design strength 5000 psi.

NOTE 3—The design earth cover indicated is the height of fill above the top of the box section. Design requirements are based on the material and soil properties, loading data, and typical section as included in Appendix X1. For alternative or special designs, see 7.2.

NOTE 4—Design steel area in square inches per linear foot of box section at those locations which are indicated on the typical section included in Fig. 1.

NOTE 5—The top section designation, for example, 3 ft by 2 ft by 4 in. indicates (interior horizontal span in feet) by (interior vertical rise in feet) by (wall and slab thickness in inches).

NOTE 6—In accordance with the acceptance criteria in 7.2, the manufacturer may interpolate the steel area requirements for fill heights between noted increments or may submit independent designs.

3 ft by 2 ft by 4 in.														
Span ft	Rise ft	Top in.	Bottom in.	Side in.	Haunch in.	Design Earth Cover ft	Circumferential Reinforcement Areas, in. <sup>2</sup> /ft							
							A <sub>s1</sub>	A <sub>s2</sub>	A <sub>s3</sub>	A <sub>s4</sub>	A <sub>s5</sub>	A <sub>s7</sub>	A <sub>s8</sub>	“M,” in.
3	2	7	6	4	4	0<2	0.17	0.38	0.21	0.10	0.19	0.17	0.14	
3	2	4	4	4	4	2<3	0.13	0.21	0.21	0.10				31
3	2	4	4	4	4	3-5	0.10	0.10	0.10	0.10				31
3	2	4	4	4	4	10	0.10	0.10	0.10	0.10				31
3	2	4	4	4	4	15	0.10	0.14	0.14	0.10				31
3	2	4	4	4	4	20	0.11	0.18	0.19	0.10				31
3	2	4	4	4	4	25	0.14	0.23	0.23	0.10				31
3	2	4	4	4	4	30	0.17	0.27	0.27	0.10				31
3	2	4	4	4	4	35	0.20	0.31	0.31	0.10				31
3 ft by 3 ft by 4 in.														
Span ft	Rise ft	Top in.	Bottom in.	Side in.	Haunch in.	Design Earth Cover ft	Circumferential Reinforcement Areas, in. <sup>2</sup> /ft							
							A <sub>s1</sub>	A <sub>s2</sub>	A <sub>s3</sub>	A <sub>s4</sub>	A <sub>s5</sub>	A <sub>s7</sub>	A <sub>s8</sub>	“M,” in.
3	3	7	6	4	4	0<2	0.17	0.40	0.23	0.10	0.20	0.17	0.14	
3	3	4	4	4	4	2<3	0.10	0.25	0.25	0.10				31
3	3	4	4	4	4	3-5	0.10	0.10	0.11	0.10				31
3	3	4	4	4	4	10	0.10	0.11	0.11	0.10				31
3	3	4	4	4	4	15	0.10	0.15	0.16	0.10				31
3	3	4	4	4	4	20	0.10	0.20	0.20	0.10				31
3	3	4	4	4	4	25	0.10	0.24	0.25	0.10				31
3	3	4	4	4	4	30	0.12	0.29	0.29	0.10				31
3	3	4	4	4	4	35	0.14	0.33	0.34	0.10				31
4 ft by 2 ft by 5 in.														
Span ft	Rise ft	Top in.	Bottom in.	Side in.	Haunch in.	Design Earth Cover ft	Circumferential Reinforcement Areas, in. <sup>2</sup> /ft							
							A <sub>s1</sub>	A <sub>s2</sub>	A <sub>s3</sub>	A <sub>s4</sub>	A <sub>s5</sub>	A <sub>s7</sub>	A <sub>s8</sub>	“M,” in.
4	2	7.5	6	5	5	0<2	0.18	0.40	0.20	0.12	0.20	0.18	0.14	
4	2	5	5	5	5	2<3	0.21	0.23	0.20	0.12				38
4	2	5	5	5	5	3-5	0.12	0.12	0.12	0.12				38
4	2	5	5	5	5	10	0.12	0.12	0.13	0.12				38
4	2	5	5	5	5	15	0.14	0.17	0.18	0.12				38
4	2	5	5	5	5	20	0.19	0.23	0.23	0.12				38
4	2	5	5	5	5	25	0.23	0.28	0.28	0.12				38



4	2	5	5	5	5	30	0.28	0.33	0.33	0.12	38
4	2	5	5	5	5	35	0.33	0.38	0.39	0.12	38

4 ft by 3 ft by 5 in.

Span ft	Rise ft	Top in.	Bottom in.	Side in.	Haunch in.	Design Earth Cover ft	Circumferential Reinforcement Areas, in. <sup>2</sup> /ft								"M," in.
							A <sub>s1</sub>	A <sub>s2</sub>	A <sub>s3</sub>	A <sub>s4</sub>	A <sub>s5</sub>	A <sub>s7</sub>	A <sub>s8</sub>		
4	3	7.5	6	5	5	0<2	0.18	0.45	0.23	0.12	0.22	0.18	0.14		
4	3	5	5	5	5	2<3	0.16	0.28	0.25	0.12				38	
4	3	5	5	5	5	3-5	0.12	0.12	0.13	0.12				38	
4	3	5	5	5	5	10	0.12	0.14	0.15	0.12				38	
4	3	5	5	5	5	15	0.12	0.20	0.20	0.12				38	
4	3	5	5	5	5	20	0.14	0.26	0.26	0.12				38	
4	3	5	5	5	5	25	0.17	0.32	0.32	0.12				38	
4	3	5	5	5	5	30	0.21	0.38	0.38	0.12				38	
4	3	5	5	5	5	35	0.25	0.44	0.44	0.12				38	

4 ft by 4 ft by 5 in.

Span ft	Rise ft	Top in.	Bottom in.	Side in.	Haunch in.	Design Earth Cover ft	Circumferential Reinforcement Areas, in. <sup>2</sup> /ft								"M," in.
							A <sub>s1</sub>	A <sub>s2</sub>	A <sub>s3</sub>	A <sub>s4</sub>	A <sub>s5</sub>	A <sub>s7</sub>	A <sub>s8</sub>		
4	4	7.5	6	5	5	0<2	0.18	0.47	0.25	0.12	0.23	0.18	0.14		
4	4	5	5	5	5	2<3	0.13	0.31	0.28	0.12				38	
4	4	5	5	5	5	3-5	0.12	0.14	0.15	0.12				38	
4	4	5	5	5	5	10	0.12	0.15	0.16	0.12				38	
4	4	5	5	5	5	15	0.12	0.21	0.22	0.12				38	
4	4	5	5	5	5	20	0.12	0.27	0.28	0.12				38	
4	4	5	5	5	5	25	0.14	0.33	0.34	0.12				38	
4	4	5	5	5	5	30	0.17	0.39	0.40	0.12				38	
4	4	5	5	5	5	35	0.20	0.45	0.46	0.12				38	

5 ft by 3 ft by 5 in.

Span ft	Rise ft	Top in.	Bottom in.	Side in.	Haunch in.	Design Earth Cover ft	Circumferential Reinforcement Areas, in. <sup>2</sup> /ft								"M," in.
							A <sub>s1</sub>	A <sub>s2</sub>	A <sub>s3</sub>	A <sub>s4</sub>	A <sub>s5</sub>	A <sub>s7</sub>	A <sub>s8</sub>		
5	3	8	7	6	6	0<2	0.19	0.44	0.22	0.14	0.21	0.19	0.17		
5	3	6	6	6	6	2<3	0.21	0.29	0.22	0.14				45	
5	3	6	6	6	6	3-5	0.14	0.14	0.14	0.14				36	
5	3	6	6	6	6	10	0.14	0.17	0.17	0.14				36	
5	3	6	6	6	6	15	0.17	0.24	0.24	0.14				35	
5	3	6	6	6	6	20	0.21	0.31	0.31	0.14				35	
5	3	6	6	6	6	25	0.26	0.38	0.38	0.14				35	
5	3	6	6	6	6	30	0.31	0.45	0.45	0.14				35	
5	3	6	6	6	6	35	0.37	0.52	0.53	0.14				35	

5 ft by 4 ft by 5 in.

Span ft	Rise ft	Top in.	Bottom in.	Side in.	Haunch in.	Design Earth Cover ft	Circumferential Reinforcement Areas, in. <sup>2</sup> /ft								"M," in.
							A <sub>s1</sub>	A <sub>s2</sub>	A <sub>s3</sub>	A <sub>s4</sub>	A <sub>s5</sub>	A <sub>s7</sub>	A <sub>s8</sub>		
5	4	8	7	6	6	0<2	0.19	0.48	0.24	0.14	0.22	0.19	0.17		
5	4	6	6	6	6	2<3	0.18	0.33	0.25	0.14				45	
5	4	6	6	6	6	3-5	0.14	0.16	0.16	0.14				45	
5	4	6	6	6	6	10	0.14	0.19	0.19	0.14				36	
5	4	6	6	6	6	15	0.14	0.26	0.27	0.14				35	
5	4	6	6	6	6	20	0.18	0.33	0.34	0.14				35	
5	4	6	6	6	6	25	0.21	0.41	0.42	0.14				35	
5	4	6	6	6	6	30	0.26	0.49	0.49	0.14				35	
5	4	6	6	6	6	35	0.30	0.56	0.57	0.14				35	

5 ft by 5 ft by 5 in.

Span ft	Rise ft	Top in.	Bottom in.	Side in.	Haunch in.	Design Earth Cover ft	Circumferential Reinforcement Areas, in. <sup>2</sup> /ft								"M," in.
							A <sub>s1</sub>	A <sub>s2</sub>	A <sub>s3</sub>	A <sub>s4</sub>	A <sub>s5</sub>	A <sub>s7</sub>	A <sub>s8</sub>		
5	5	8	7	6	6	0<2	0.19	0.50	0.26	0.14	0.24	0.19	0.17		
5	5	6	6	6	6	2<3	0.16	0.35	0.28	0.14				45	
5	5	6	6	6	6	3-5	0.14	0.17	0.18	0.14				45	
5	5	6	6	6	6	10	0.14	0.20	0.21	0.14				45	
5	5	6	6	6	6	15	0.14	0.27	0.28	0.14				36	
5	5	6	6	6	6	20	0.15	0.35	0.36	0.14				35	
5	5	6	6	6	6	25	0.19	0.42	0.44	0.14				35	
5	5	6	6	6	6	30	0.22	0.50	0.51	0.14				35	
5	5	6	6	6	6	35	0.26	0.58	0.59	0.14				35	

6 ft by 3 ft by 7 in.

Span ft	Rise ft	Top in.	Bottom in.	Side in.	Haunch in.	Design Earth Cover ft	Circumferential Reinforcement Areas, in. <sup>2</sup> /ft								"M," in.
							A <sub>s1</sub>	A <sub>s2</sub>	A <sub>s3</sub>	A <sub>s4</sub>	A <sub>s5</sub>	A <sub>s7</sub>	A <sub>s8</sub>		
6	3	8	7	7	7	0<2	0.23	0.45	0.20	0.17	0.19	0.19	0.17		
6	3	7	7	7	7	2<3	0.24	0.30	0.20	0.17				43	
6	3	7	7	7	7	3-5	0.17	0.17	0.17	0.17				40	
6	3	7	7	7	7	10	0.17	0.20	0.20	0.17				39	
6	3	7	7	7	7	15	0.23	0.27	0.28	0.17				38	

6	3	7	7	7	7	20	0.30	0.35	0.36	0.17						38
6	3	7	7	7	7	25	0.36	0.44	0.44	0.17						38
6	3	7	7	7	7	30	0.43	0.52	0.52	0.17						38
6	3	7	7	7	7	35	0.50	0.60	0.60	0.17						38

**6 ft by 4 ft by 7 in.**

Span ft	Rise ft	Top in.	Bottom in.	Side in.	Haunch in.	Design Earth Cover ft	Circumferential Reinforcement Areas, in. <sup>2</sup> /ft								"M," in.	
							A <sub>s1</sub>	A <sub>s2</sub>	A <sub>s3</sub>	A <sub>s4</sub>	A <sub>s5</sub>	A <sub>s7</sub>	A <sub>s8</sub>			
6	4	8	7	7	7	0<2	0.19	0.49	0.23	0.17	0.21	0.19	0.17			
6	4	7	7	7	7	2<3	0.21	0.33	0.23	0.17						43
6	4	7	7	7	7	3-5	0.17	0.17	0.17	0.17						40
6	4	7	7	7	7	10	0.17	0.22	0.23	0.17						39
6	4	7	7	7	7	15	0.20	0.30	0.31	0.17						38
6	4	7	7	7	7	20	0.25	0.39	0.40	0.17						38
6	4	7	7	7	7	25	0.30	0.48	0.49	0.17						38
6	4	7	7	7	7	30	0.36	0.57	0.58	0.17						38
6	4	7	7	7	7	35	0.42	0.66	0.67	0.17						38

**6 ft by 5 ft by 7 in.**

Span ft	Rise ft	Top in.	Bottom in.	Side in.	Haunch in.	Design Earth Cover ft	Circumferential Reinforcement Areas, in. <sup>2</sup> /ft								"M," in.	
							A <sub>s1</sub>	A <sub>s2</sub>	A <sub>s3</sub>	A <sub>s4</sub>	A <sub>s5</sub>	A <sub>s7</sub>	A <sub>s8</sub>			
6	5	8	7	7	7	0<2	0.19	0.52	0.25	0.17	0.22	0.19	0.17			
6	5	7	7	7	7	2<3	0.19	0.36	0.26	0.17						52
6	5	7	7	7	7	3-5	0.17	0.19	0.19	0.17						43
6	5	7	7	7	7	10	0.17	0.23	0.24	0.17						39
6	5	7	7	7	7	15	0.17	0.32	0.33	0.17						38
6	5	7	7	7	7	20	0.22	0.41	0.43	0.17						38
6	5	7	7	7	7	25	0.26	0.51	0.52	0.17						38
6	5	7	7	7	7	30	0.31	0.60	0.61	0.17						38
6	5	7	7	7	7	35	0.36	0.69	0.71	0.17						38

**6 ft by 6 ft by 7 in.**

Span ft	Rise ft	Top in.	Bottom in.	Side in.	Haunch in.	Design Earth Cover ft	Circumferential Reinforcement Areas, in. <sup>2</sup> /ft								"M," in.	
							A <sub>s1</sub>	A <sub>s2</sub>	A <sub>s3</sub>	A <sub>s4</sub>	A <sub>s5</sub>	A <sub>s7</sub>	A <sub>s8</sub>			
6	6	8	7	7	7	0<2	0.19	0.54	0.27	0.17	0.23	0.19	0.17			
6	6	7	7	7	7	2<3	0.17	0.38	0.28	0.17						52
6	6	7	7	7	7	3-5	0.17	0.20	0.20	0.17						52
6	6	7	7	7	7	10	0.17	0.24	0.26	0.17						43
6	6	7	7	7	7	15	0.17	0.33	0.35	0.17						39
6	6	7	7	7	7	20	0.19	0.43	0.44	0.17						38
6	6	7	7	7	7	25	0.23	0.52	0.54	0.17						38
6	6	7	7	7	7	30	0.27	0.61	0.63	0.17						38
6	6	7	7	7	7	35	0.32	0.71	0.73	0.17						38

**7 ft by 4 ft by 8 in.**

Span ft	Rise ft	Top in.	Bottom in.	Side in.	Haunch in.	Design Earth Cover ft	Circumferential Reinforcement Areas, in. <sup>2</sup> /ft								"M," in.	
							A <sub>s1</sub>	A <sub>s2</sub>	A <sub>s3</sub>	A <sub>s4</sub>	A <sub>s5</sub>	A <sub>s7</sub>	A <sub>s8</sub>			
7	4	8	8	8	8	0<2	0.26	0.49	0.21	0.19	0.19	0.19	0.19			
7	4	8	8	8	8	2<3	0.24	0.33	0.22	0.19						47
7	4	8	8	8	8	3-5	0.19	0.19	0.19	0.19						43
7	4	8	8	8	8	10	0.19	0.25	0.25	0.19						43
7	4	8	8	8	8	15	0.26	0.34	0.35	0.19						41
7	4	8	8	8	8	20	0.33	0.44	0.45	0.19						41
7	4	8	8	8	8	25	0.40	0.54	0.55	0.19						41
7	4	8	8	8	8	30	0.47	0.64	0.65	0.19						41
7	4	8	8	8	8	35	0.55	0.75	0.75	0.19						41

**7 ft by 5 ft by 8 in.**

Span ft	Rise ft	Top in.	Bottom in.	Side in.	Haunch in.	Design Earth Cover ft	Circumferential Reinforcement Areas, in. <sup>2</sup> /ft								"M," in.	
							A <sub>s1</sub>	A <sub>s2</sub>	A <sub>s3</sub>	A <sub>s4</sub>	A <sub>s5</sub>	A <sub>s7</sub>	A <sub>s8</sub>			
7	5	8	8	8	8	0<2	0.23	0.52	0.24	0.19	0.21	0.19	0.19			
7	5	8	8	8	8	2<3	0.22	0.36	0.25	0.19						59
7	5	8	8	8	8	3-5	0.19	0.20	0.20	0.19						43
7	5	8	8	8	8	10	0.19	0.27	0.28	0.19						43
7	5	8	8	8	8	15	0.23	0.37	0.38	0.19						41
7	5	8	8	8	8	20	0.29	0.48	0.49	0.19						41
7	5	8	8	8	8	25	0.35	0.58	0.59	0.19						41
7	5	8	8	8	8	30	0.41	0.69	0.70	0.19						41
7	5	8	8	8	8	35	0.47	0.80	0.81	0.19						41

**7 ft by 6 ft by 8 in.**

Span ft	Rise ft	Top in.	Bottom in.	Side in.	Haunch in.	Design Earth Cover ft	Circumferential Reinforcement Areas, in. <sup>2</sup> /ft								"M," in.	
							A <sub>s1</sub>	A <sub>s2</sub>	A <sub>s3</sub>	A <sub>s4</sub>	A <sub>s5</sub>	A <sub>s7</sub>	A <sub>s8</sub>			
7	6	8	8	8	8	0<2	0.21	0.54	0.26	0.19	0.22	0.19	0.19			
7	6	8	8	8	8	2<3	0.20	0.39	0.27	0.19						59
7	6	8	8	8	8	3-5	0.19	0.22	0.22	0.19						47
7	6	8	8	8	8	10	0.19	0.28	0.30	0.19						43
7	6	8	8	8	8	15	0.20	0.39	0.40	0.19						41