



Designation: **E2491—08 E2491 – 13**

Standard Guide for Evaluating Performance Characteristics of Phased-Array Ultrasonic Testing Instruments and Systems¹

This standard is issued under the fixed designation E2491; the number immediately following the designation indicates the year of original adoption or, in the case of revision, the year of last revision. A number in parentheses indicates the year of last reapproval. A superscript epsilon (ϵ) indicates an editorial change since the last revision or reapproval.

1. Scope—Scope*

1.1 This guide describes procedures for evaluating some performance characteristics of phased-array ultrasonic examination instruments and systems.

1.2 Evaluation of these characteristics is intended to be used for comparing instruments and systems or, by periodic repetition, for detecting long-term changes in the characteristics of a given instrument or system that may be indicative of impending failure, and which, if beyond certain limits, will require corrective maintenance. Instrument characteristics measured in accordance with this guide are expressed in terms that relate to their potential usefulness for ultrasonic examinations. Other electronic instrument characteristics in phased-array units are similar to non-phased-array units and may be measured as described in Guide E1065 or E1324.

1.3 Ultrasonic examination systems using pulsed-wave trains and A-scan presentation (rf or video) may be evaluated.

1.4 This guide establishes no performance limits for examination systems; if such acceptance criteria are required, these must be specified by the using parties. Where acceptance criteria are implied herein they are for example only and are subject to more or less restrictive limits imposed by customer's and end user's controlling documents.

1.5 The specific parameters to be evaluated, conditions and frequency of test, and report data required, must also be determined by the user.

1.6 This guide may be used for the evaluation of a complete examination system, including search unit, instrument, interconnections, scanner fixtures and connected alarm and auxiliary devices, primarily in cases where such a system is used repetitively without change or substitution. This guide is not intended to be used as a substitute for calibration or standardization of an instrument or system to inspect any given material.

1.7 Required test apparatus includes selected test blocks and position encoders in addition to the instrument or system to be evaluated.

1.8 Precautions relating to the applicability of the procedures and interpretation of the results are included.

1.9 Alternate procedures, such as examples described in this document, or others, may only be used with customer approval.

1.10 The values stated in SI units are to be regarded as standard. No other units of measurement are included in this standard.

1.11 *This standard does not purport to address all of the safety concerns, if any, associated with its use. It is the responsibility of the user of this standard to establish appropriate safety and health practices and determine the applicability of regulatory limitations prior to use.*

2. Referenced Documents

2.1 *ASTM Standards:*²

[E317 Practice for Evaluating Performance Characteristics of Ultrasonic Pulse-Echo Testing Instruments and Systems without the Use of Electronic Measurement Instruments](#)

[E494 Practice for Measuring Ultrasonic Velocity in Materials](#)

[E1065 Guide for Evaluating Characteristics of Ultrasonic Search Units](#)

¹ This guide is under the jurisdiction of ASTM Committee E07 on Nondestructive Testing and is the direct responsibility of Subcommittee E07.06 on Ultrasonic Method. Current edition approved July 1, 2008; June 1, 2013. Published August 2008; June 2013. Originally approved in 2006. Last previous edition approved in 2006 as E2491—06; E2491—08. DOI: 10.1520/E2491-08; 10.1520/E2491-13.

² For referenced ASTM standards, visit the ASTM website, www.astm.org, or contact ASTM Customer Service at service@astm.org. For *Annual Book of ASTM Standards* volume information, refer to the standard's Document Summary page on the ASTM website.

*A Summary of Changes section appears at the end of this standard

3. Terminology

3.1 Refer to Terminology [E1316](#) for definitions of terms in this ~~guide~~guide.

3.2 ~~Definitions:~~

3.2.1 *angle corrected gain*—also called ACG. Is compensation applied to focal laws in an S-scan to correct for the effects of echo-transmittance variation at different angles. This may be accomplished by equalizing the amplitude response in the far field from a uniform reflector at a constant sound path through the range of angles used in the S-scan. An “infinite radius” such as that provided by the 100 mm radius of the HW block is a convenient target for this function. A series of side drilled holes arranged in a radiused pattern may also present uniform reflectors at a constant sound path but the corrections are then in angular increments. Note that there are technical limits to ACG, that is, beyond a certain angular range, compensation is not possible.

3.2.2 *annular array probes*—phased-array probes that have the transducers configured as a set of concentric rings. They allow the beam to be focused to different depths along an axis. The surface area of the rings is in most cases constant, which implies a different width for each ring.

3.2.3 *array (phased)*—a patterned arrangement of elements. Typical arrangements include linear, annular, two dimensional matrix, and “rho-theta”.

3.2.4 *electronic scan*—also termed an E-scan. The same focal law is multiplexed across a group of active elements; electronic raster scanning is performed at a constant angle and along the phased-array probe length. This is equivalent to a conventional ultrasonic probe performing a raster scan. Also called electronic scanning.

3.2.5 *focal law*—the entire set of hardware and software parameters affecting the acoustic sensitivity field of a phased array search unit, whether a pulse-echo or a pitch-catch configuration. Within focal laws, there are included delay laws in transmitter and delay laws in receiver, as well as apodization laws, and element activation laws.

3.2.6 *linear array probes*—probes made using a set of elements juxtaposed and aligned along a linear axis. They enable a beam to be moved, focused, and deflected along a single azimuthal plane.

3.2.7 *matrix array probes*—these probes have an active area divided in two dimensions in different elements. This division can, for example, be in the form of a checkerboard, or sectorized rings. These probes allow the ultrasonic beam steering in more than one plane.

3.2.8 *sectorial scan*—also termed an S-scan or azimuthal scan. This may refer to either the beam movement or the data display. As a data display it is a 2D view of all A-scans from a specific set of elements corrected for delay and refracted angle. When used to refer to the beam movement it refers to the set of focal laws that sweeps a defined range of angles using the same set of elements.

3.2.9 *S-scan*—(q.v. sectorial scan)

4. Summary of Guide

4.1 Phased-array instruments and systems have similar individual components as are found in traditional ultrasonic systems that are based on single channel or multiplexed pulse-echo units. These include pulsers, receivers, probes and interconnecting cables. The most significant difference is that phased-array systems form the transmitted ultrasonic pulse by constructive phase interference from the wavelets formed off the individually pulsed elements of the phased-array probes.

4.2 Each phased-array probe consists of a series of individually wired elements that are activated separately using a programmable time delay pattern. Varying the number of elements used and the delay time between the pulses to each element allows control of the beam. Depending on the probe design, it is possible to electronically vary the angle (incident or skew), or the focal distance, or the beam dimensions, or a combination of the three. In the receiving mode, acoustic energy is received by the elements and the signals undergo a summation process utilizing the same type of time delay process as was used during transmission.

4.3 The degree of beam steering available is dependent on several parameters including; number of elements, pitch of the element spacing, element dimensions, element array shape, resonant frequency of the elements, the material into which the beam is directed, the minimum delay possible between firing of adjacent pulsers and receivers and the pulser voltage characteristics.

4.4 Pulser and receiver parameters in phased-array systems are generally computer controlled and the received signals are typically displayed on computer monitors via computer data acquisition systems and may be stored to computer files.

4.5 Although most systems use piezo-electric materials for the elements, electro-magnetic acoustic transducer (EMAT) devices have also been designed and built using phased-array instrumentation.

4.6 Most phased array systems can use encoders for automated and semi-automated scanning.

4.7 Side Drilled Holes used as targets in this document should have diameters less than the wavelength of the pulse being assessed and long enough to avoid end effects from causing interfering signals. This will typically be accomplished when the hole diameter is between about 1.5 mm and 2.5 mm and 20 mm to 25 mm in length.

5. Significance and Use

5.1 This guide is intended to evaluate performance assessment of combinations of phased-array probes and instruments. It is not intended to define performance and acceptance criteria, but rather to provide data from which such criteria may be established.

5.2 Recommended procedures described in this guide are intended to provide performance-related measurements that can be reproduced under the specified test conditions using simple targets and the phased-array test system itself. It is intended for phased-array flaw detection instruments operating in the nominal frequency range of 1 MHz to 20 MHz, but the procedures are applicable to measurements on instruments utilizing significantly higher frequency components.

5.3 This guide is not intended for service calibration, or maintenance of circuitry for which the manufacturer's instructions are available.

5.4 Implementation of specific assessments may require more detailed procedural instructions in a format of the using facility.

5.5 The measurement data obtained may be employed by users of this guide to specify, describe, or provide a performance criteria for procurement and quality assurance, or service evaluation of the operating characteristics of phased-array systems.

5.6 Not all assessments described in this guide are applicable to all systems. All or portions of the guide may be used as determined by the user.

6. Procedure

6.1 Procedures for assessment of several parameters in phased-array systems are described in Annexes A1 to A7.

6.1.1 These include; determination of beam profile, beam steering capability, element activity, focusing capability, software calculations (controls and display of received signals), compensation for wedge attenuation, receiver gain linearity.

7. Keywords

7.1 characterization; focal point; phased-array; phased-array probe; sound beam profile; ultrasound

ANNEXES

(Mandatory Information)

A1. DETERMINATION OF PHASED-ARRAY BEAM PROFILE

A1.1 Introduction

A1.1.1 This annex describes procedures to determine beam profiles of phased-array probes. Either immersion or contact probe applications can be addressed using these procedures. However, it should be cautioned that assessments of contact probes may suffer from variability greater than imposed tolerances if proper precautions are not taken to ensure constant coupling conditions.

A1.2 Test Setup

A1.2.1 For single focal laws where the beam is fixed (that is, not used in an electronic or sectorial scan mode) and the probe is used in an immersion setup, the ball-target or hydrophone options described in **E1065** may be used. For phased array probes used in a dynamic fashion where several focal laws are used to produce sectorial or electronic scanning it may be possible to make beam-profile assessments with no or little mechanical motion. Where mechanical motion is used it shall be encoded to relate signal time and amplitude to distance moved. Encoder accuracy shall be verified to be within tolerances appropriate for the measurements made. Descriptions made for electronic scan and sectorial scan beam profile assessments will be made for contact probes; however, when assessment in water is required the machined targets may be replaced with rods or balls as appropriate.

A1.2.2 *Linear-Array Probes*—Linear-array probes have an active plane and an inactive or passive plane. Assessment of the beam in the active plane should be made by use of an electronic scan sequence for probes with sufficient number of elements to electronically advance the beam past the targets of interest. For phased array probes using a large portion of the available elements

to form the beam the number of remaining elements for the electronic raster may be too small to allow the beam to pass over the target. In this case it will be necessary to have encoded mechanical motion and assess each focal law along the active plane separately.

A1.2.3 Side-drilled holes should be arranged at various depths in a flaw-free sample of the test material in which focal laws have been programmed for. Using the linear scan feature of the phased-array system the beam is passed over the targets at the various depths of interest. The electronic scan is illustrated schematically in Fig. A1.1.

A1.2.4 Data collection of the entire waveform over the range of interest shall be made. The display shall represent amplitude as a color or grayscale. Time or equivalent distance in the test material shall be presented along one axis and distance displaced along the other axis. This is a typical B-scan as illustrated in Fig. A1.2.

A1.2.5 Data display for an electronic scan using a phased-array probe mounted on a wedge can be similarly made using simple orthogonal representation of time versus displacement or it can be angle corrected as illustrated in Fig. A1.3.

A1.2.6 Resolution along the displacement axis will be a function of the step size of the electronic scan or, if the scan uses an encoded mechanical fixture the resolution will be dependent on the encoder step-size used for sampling.

A1.2.7 Resolution along the beam axis will be a function of the intervals between the target paths. For highly focused beams it may be desirable to have small differences between the sound paths to the target paths (for example, 1 mm or 2 mm).

A1.2.8 Beam profiling in the passive plane can also be made. The passive plane in a linear-array probe is perpendicular to the active plane and refers to the plane in which no beam steering is possible by phasing effects. Beam profiling in the passive direction will require mechanical scanning.

A1.2.9 Waveform collection of signals using a combination of electronic scanning in the active plane and encoded mechanical motion in the passive plane provides data that can be projection-corrected to provide beam dimensions in the passive plane. Fig. A1.4 illustrates a method for beam assessment in the passive plane. This technique uses a corner reflection from an end-drilled hole at depths established by a series of steps.

A1.2.10 Fig. A1.5 illustrates an alternative to the stepped intervals shown in Fig. A1.4. A through hole may be arranged perpendicular to the required refracted angle to provide a continuous transition of path length to the target.

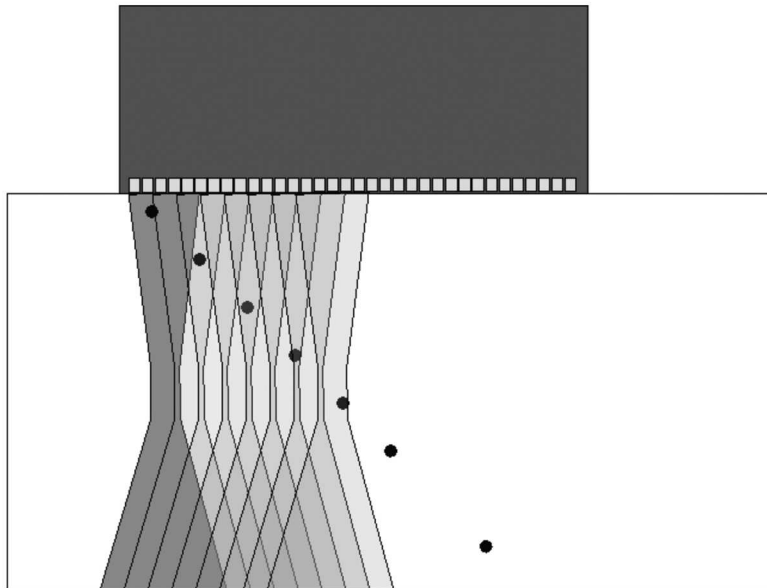

FIG. A1.1 Electronic Scan of Side Drilled Holes

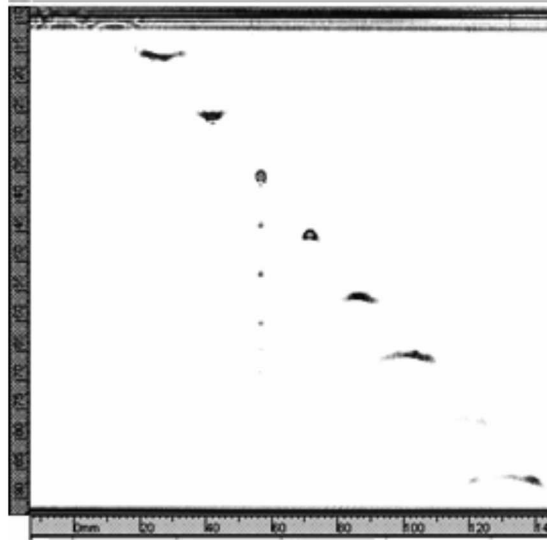

FIG. A1.2 B-Scan Display of Electronic Scan Represented in Fig. A1.1 (Depth is in the vertical axis and electronic-scan distance is represented along the horizontal axis.)

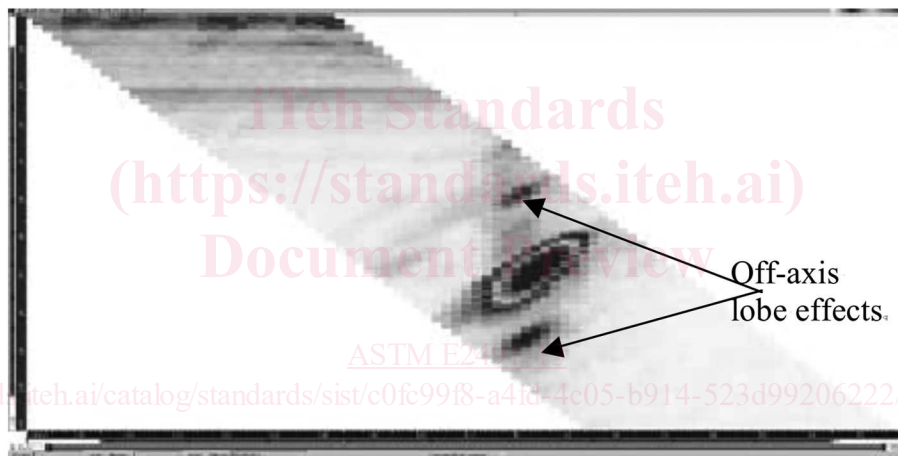

FIG. A1.3 Angle-Corrected B-Scan of a Phased-Array Beam (in Shear Wave Mode) from a Side Drilled Hole (Off-axis lobe effects can be seen in the display.)

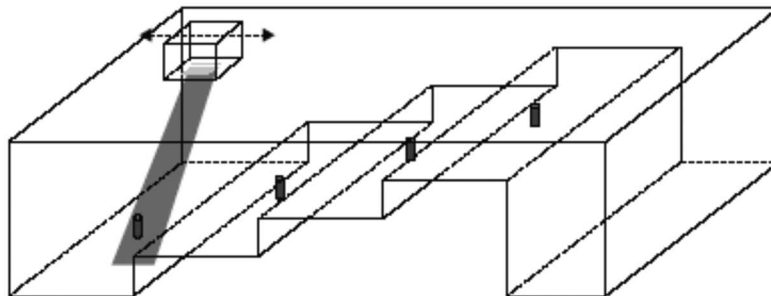

FIG. A1.4 Scanning End-Drilled Holes to Obtain Beam Dimensions in Passive Plane

A1.2.11 A projected C-scan can be used to size the beam based on either color or grayscale indicating amplitude drop or a computer display that plots amplitude with respect to displacement. The projected C-scan option is schematically represented in Fig. A1.6.

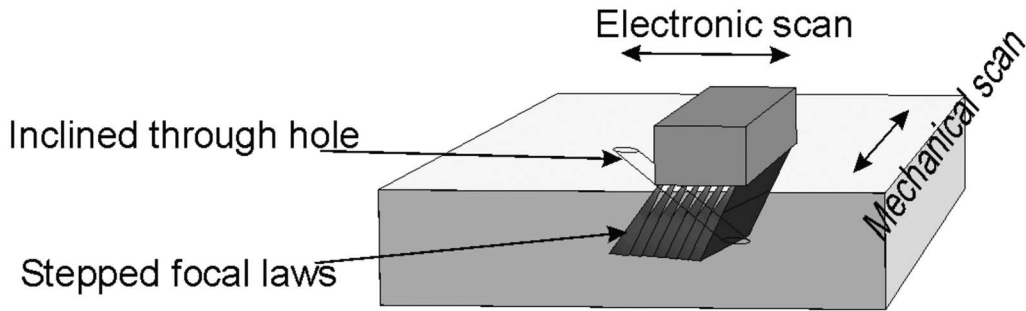

FIG. A1.5 Representation of an Inclined Hole for Beam Characterization in the Passive Plane

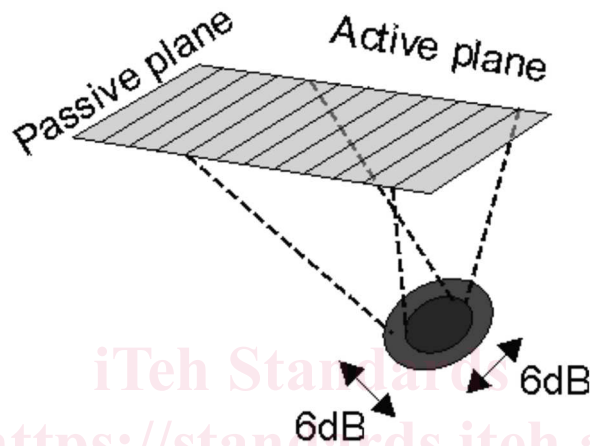

FIG. A1.6 Representation of Projected C-Scan of Corner Effect Scan Seen in Fig. A1.4

ASTM E2491-13 A2. DETERMINATION OF PHASED-ARRAY BEAM STEERING LIMITS

A2.1 Introduction

A2.1.1 This annex describes procedures to determine practical limits for beam steering capabilities of a phased-array probe and as such applies to the active plane(s) only. Either immersion or contact probe applications can be addressed using these procedures. However, it should be cautioned that assessments of contact probes may suffer from variability greater than imposed tolerances if proper precautions are not taken to ensure constant coupling conditions.

A2.1.2 Recommended limits to establish the working range of angular sweep of a phased-array probe relate to the divergence of the beam of each element in the probe array. When used in pulse-echo mode the steering limit is considered to be within the 6-dB divergence envelope of the individual elements. It is therefore possible to calculate a theoretical limit based on nominal frequency and manufacturer provided information on the element dimensions. However, several parameters can affect the theoretical calculations. These are primarily related to the nominal frequency of the probe. Some parameters affecting actual frequency include; pulse length, damping, use of a delay-line or refracting wedge and variations in manufacturing processes on thickness lapping and matching layers.

A2.1.3 For the purposes of this procedure, assessment of beam steering capability will be based on a comparison of signal to noise ratios at varying angular displacements. Beam steering capability will also be affected by project requirements of the beam. Applications where focusing is necessary may not achieve the same limits as applications where the beam is not focused as well as steered.

A2.1.4 Steering capability may be specific to a sound path distance, aperture and material.

A2.2 *Test Set-Up*—Configure the probe focal laws for the conditions of the test. This will include immersion or contact, refracting wedge or delay-line, unfocused or a defined focal distance and the test material to be used.

A2.2.1 Prepare a series of side drilled holes in the material to be used for the application at the distance or distances to be used in the application. The side-drilled-hole pattern should be as illustrated in Fig. A2.1. Holes indicated in Fig. A2.1 are at 5° intervals at a 25-mm and 50-mm distance from a center where the probe is located.

A2.2.2 Similar assessments are possible for different applications. When a set of focal laws is arranged to provide resolution in a plane instead of a sound path distance, the plane of interest may be used to assess the steering limits of the beam. The block used for assessment would be arranged with side drilled holes in the plane of interest. Such a plane-specific block is illustrated in Fig. A2.2 where a series of holes is made in a vertical and horizontal plane at a specified distance from the nominal exit point. Side drilled holes may be arranged in other planes (angles) of interest.

A2.2.3 Assessments are made placing the probe such that the center of beam ray enters the block at the indicated centerline. For analysis of a probe where all the elements in a single plane are used without a delay line or refracting wedge the midpoint of the element array shall be aligned with the centerline. For focal laws using only a portion of the total available elements the midpoint of the element aperture shall be aligned with the centerline. When delay lines, refracting wedges or immersion methods are used corrections will be required to compensate for movement of the “apparent” exit point along the block entry surface. When a probe is used in direct contact with a verification block as illustrated in Fig. A2.2 the lack of symmetry either side of the centerline prevents both positive and negative sweep angles being assessed simultaneously. To assess the sweep limit in the two directions when using this style of block requires that the probe be assessed in one direction first and then rotated 180° and the opposite sweep assessed.

A2.2.4 Angular steps between A-scan samples will have an effect on the perceived sweep limits. A maximum of 1° between S-scan samples is recommended for steering assessment. Angular steps are limited by the system timing-delay capabilities between pulses and element pitch characteristics. Most of the targets illustrated in Fig. A2.1 and Fig. A2.2 are separated by 5°; however, greater or lesser intervals may be used depending on the required resolution.

A2.2.5 Assessment of steering limits shall be made using the dB difference between the maximum and minimum signal amplitudes between two adjacent side drilled holes. For example, when a phased array probe is configured to sweep +45° on a

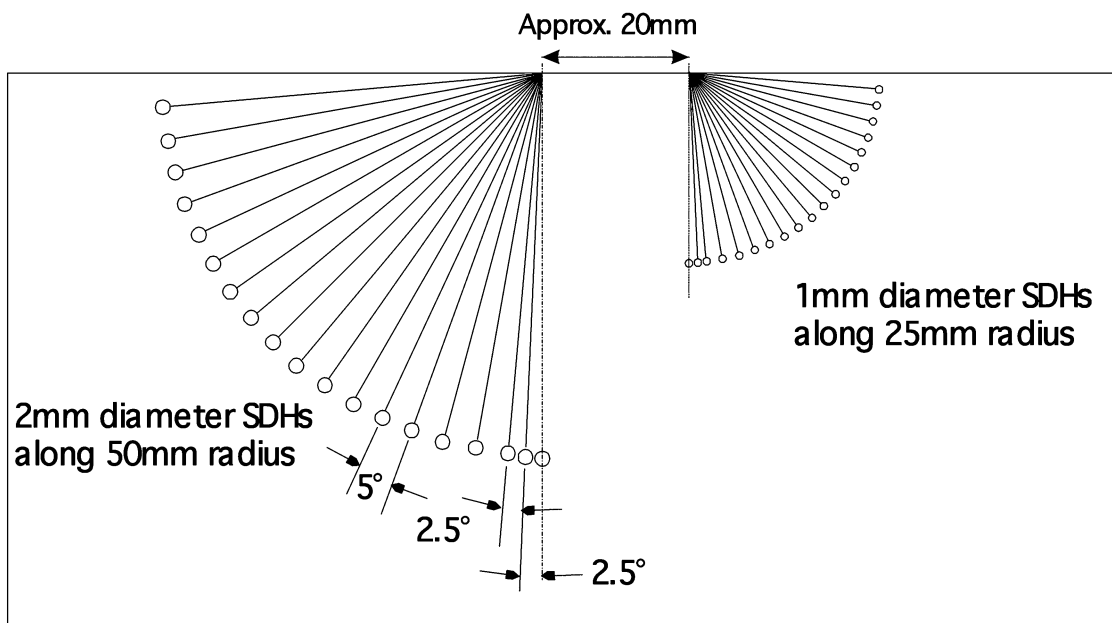

NOTE 1—Block dimensions 150 by 75 by 25 mm (typical)
FIG. A2.1 Beam Steering Assessment Block—Constant Sound Path

Vertical plane 50mm from exit point

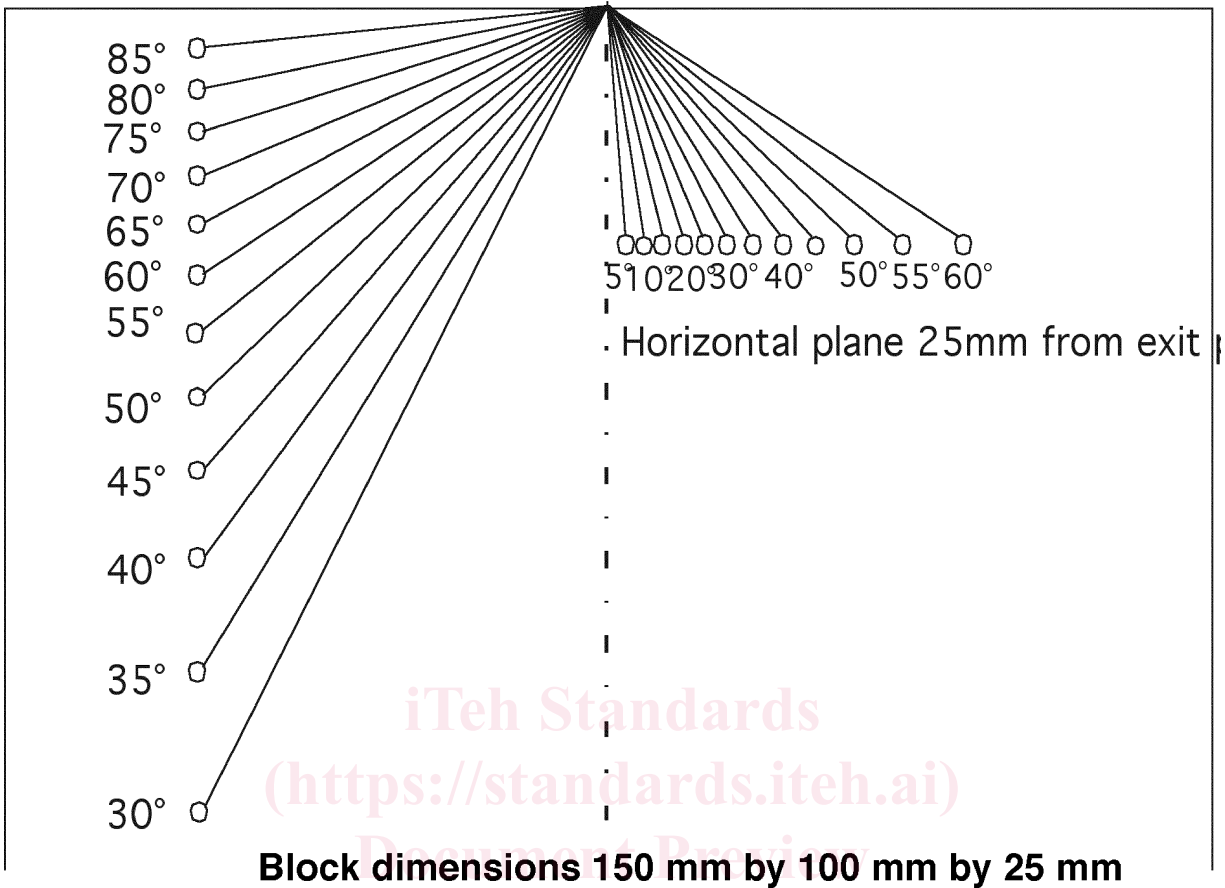

FIG. A2.2 Beam Steering Assessment Block—Single Plane

block such as illustrated in Fig. A2.1, the higher of the pair of the SDHs which achieves a 6-dB separation shall be considered the maximum steering capability of the probe configuration.

A2.2.6 Acceptable limits of steering may be indicated by the maximum and minimum angles that can achieve a pre-specified separation between adjacent holes. Depending on the application a 6dB-6dB or 20 dB-20dB (or some other value) may be specified as the required separation.

A2.2.7 Steering capabilities may be used as a prerequisite; for example, a phased array system is required to achieve a minimum steering capability for 5° resolution of 2-mm diameter side drilled holes of plus and minus 20° from a nominal mid-angle. Conversely, a system may be limited to S-scans not exceeding the angles assessed to achieve a specified signal separation, for example, -20 dB between 2-mm diameter SDHs separated by 5°.

A2.3 An alternative assessment may use a single SDH at a specified depth or sound path distance. Displaying the A-scan for the maximum and minimum angles used would assess the steering capability by observing the S/N ratio at the peaked response. Steering limit would be a pre-defined S/N ratio being achieved. Caution must be taken when using this method so as to not peak on grating lobe signals. This method will also require confirmation that the SDH is positioned at the calculated refracted angle.

A3. DETERMINATION OF PHASED-ARRAY ELEMENT ACTIVITY

A3.1 Introduction

A3.1.1 This assessment is used to determine that all elements of the phased array probe are active and of uniform acoustic energy. Because, during normal operation in a timed sequence, each of the elements is addressed by a separate pulser and receiver, a method must be used that ensures the electronic performance of the phased-array instrument is identical from element to element and any differences are attributable to the probe itself. To ensure that any variation of element performance is due only to probe construction, a single pulser-receiver channel is selected to address each element.

A3.2 Test Set-Up

A3.2.1 Connect the phased array probe to be tested to the phased-array ultrasonic instrument and remove any delay line or refracting wedge from the probe.

A3.2.2 Acoustically couple the probe to the 25-mm thickness of an IIW (International Institute of Welding) block with a uniform layer of couplant. This may be accomplished by a contact-gap technique such that the probe-to-block interface is under water (to ensure uniform coupling). Alternatively an immersion method using a fixed water path may be used and the water-steel interface signal monitored instead of the steel wall thickness.

A3.2.3 Configure an electronic scan consisting of one element that is stepped along one element at a time for the total number of elements in the array. (This should ensure that the pulser-receiver number 1 is used in each focal law or if the channel is selectable it should be the same channel used for each element). Set the pulser parameters to optimize the response for the nominal frequency of the probe array and establish a pulse-echo response from the block backwall or waterpath to 80 % display height for each element in the probe.

A3.2.4 Observe the A-scan display for each element in the array and record the receiver gain required to achieve the 80 % signal amplitude for each element. Results may be recorded on a table similar to that in **Table A3.1**.

A3.2.5 Note and record any elements that do not provide a backwall or waterpath signal (inactive elements). Results may be recorded on a table similar to that in **Table A3.1**.

A3.2.6 If a prepackaged program is available for checking element activity, this can be used as an alternative.

A3.2.7 Data collected is used to assess probe uniformity and functionality. Comparison to previous assessments is made using the same instrument settings (including gain) that were saved to file. The receiver gain to provide an 80 % response should be within a range of ± 2 dB of any previous assessments and within ± 2 dB of each other.

A3.2.8 The total number of inactive elements and number of adjacent inactive elements in a probe should be agreed upon and identified in a written procedure. This number may be different for baseline and in-service verifications. Some phased array probes may have several hundred elements and even new phased-array probes may be found to have inactive elements as a result of manufacturing difficulties ensuring the electrical connections to elements with dimensions on the order of a fraction of a millimetre.

A3.2.9 The number of inactive elements allowed should be based on performance of other capabilities such as focusing and steering limits of the focal laws being used. No simple rule for the number of inactive elements can be made for all phased-array probes. Typically, if more than 25 % of the elements in a probe are inactive, sensitivity and steering capabilities may be

TABLE A3.1 Probe Element Activity Chart: Enter Receiver Gain for 80 % FSH

Element	1	2	3	4	5	6	7	8	9	10	11	12	13	14	15	16
Gain																
Active (□)																
Inactive (x)																

compromised. Similarly, the number of adjacent elements allowed to be inactive should be determined by the steering and electronic raster resolution required by the application.

A3.2.10 Stability of coupling is essential for the comparison assessment. If using a contact method and the assessment of elements produces signals outside the ± 2 -dB range the coupling should be checked and the test run again. If still outside the acceptable range the probe should be removed from service and corrected prior to further use. The test using a fixed water path to a water/steel interface will reduce coupling variations.

A3.2.11 Prior to removing the probe from service the cable used for the test should be exchanged with another cable, when possible, to verify that the inactive elements are not due to a bad cable.

A3.2.12 Cable continuity adapters can be made that allow the multi-strand connectors to be tested independently. These adaptors can be connected to the phased array instrument directly to verify that all output channels are active or they can be connected to the probe-end of the cable to indicate the continuity of the individual co-axial connectors in the inter-connecting cable. Fig. A3.1 illustrates an example of a display used to identify inactive channels in a phased array instrument or cable.

A4. ASSESSMENT OF PHASED-ARRAY FOCUSING ABILITY

A4.1 Introduction

A4.1.1 Focusing of ultrasonic beams is based on well known principles. However, unlike single element probes, phased-array systems can be configured to focus over a range of sound paths and in both transmit and receive modes. Effectiveness of the focusing algorithms can be assessed by determining the beam response dimensions. This is similar to the beam profiling described in Annex A1. Limits of focusing are intrinsic in the probe parameters and subject to the minimum timing-delay capabilities of the phased-array ultrasonic instrument.

Document Preview

ASTM E2491-13

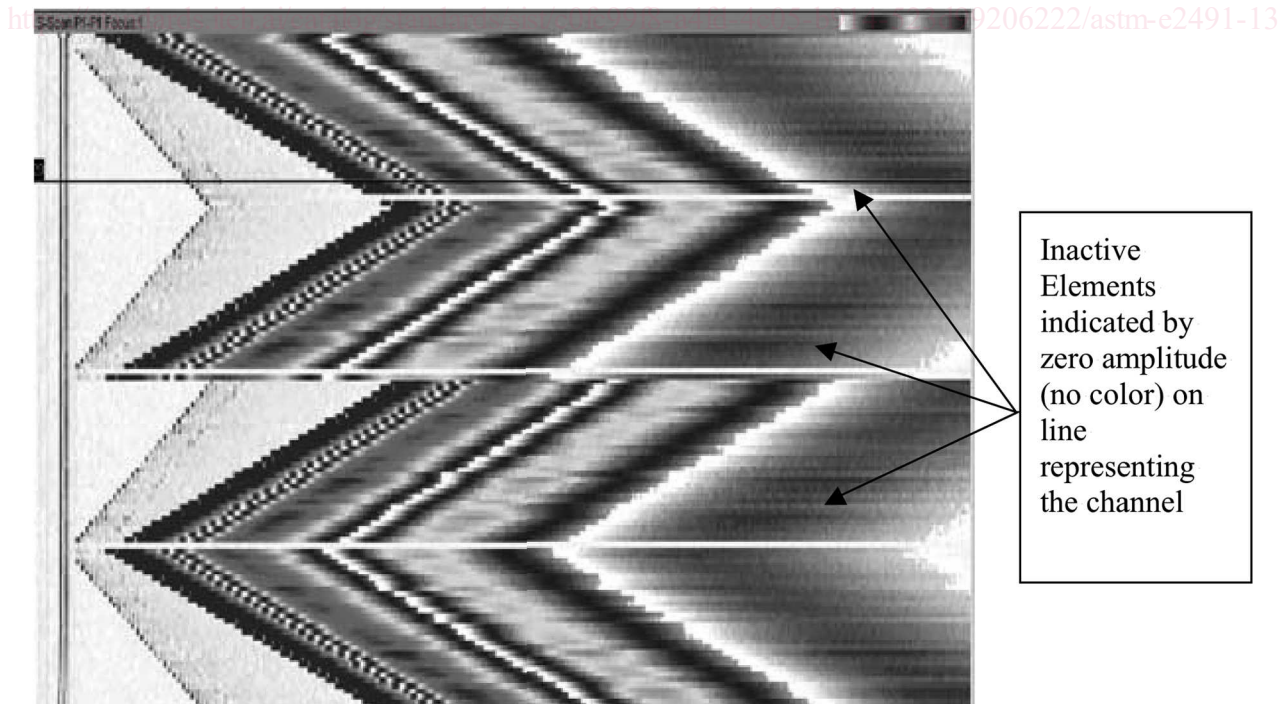

FIG. A3.1 Continuity Display for Phased-Array Instrument or Cable