



Designation: **F1667–13** **F1667 – 15**

Standard Specification for Driven Fasteners: Nails, Spikes, and Staples¹

This standard is issued under the fixed designation F1667; the number immediately following the designation indicates the year of original adoption or, in the case of revision, the year of last revision. A number in parentheses indicates the year of last reappraisal. A superscript epsilon (ϵ) indicates an editorial change since the last revision or reappraisal.

*This standard has been approved for use by agencies of the U.S. Department of Defense.
The Commercial and Government Entity (Cage) Code for ASTM: 81346.*

1. Scope*

1.1 This specification covers nails, spikes, staples, and other driven fasteners, as listed in **Table 1**.

NOTE 1—Fastener ductility information is presented in **Table 2** and dimensional information in Tables 3–65.

1.2 Fasteners described in this specification are driven by hand tool, power tool, or mechanical device in single or multiple strikes and are positioned by hand, tool, or machine.

1.3 The values stated in inch-pound units are to be regarded as standard. No other units of measurement are included in this standard.

1.4 Fasteners in this specification are sold in bulk (loose) form and are collated for loading into the magazine of an application tool. Other than as covered in Section 9, Workmanship, cohering materials (including, but not limited to, plastic, adhesive bond, paper tape, plastic strip, plastic carrier, wire, etc.) and relative orientation of collated fasteners are not within the scope of this standard.

1.5 *This standard does not purport to address all of the safety concerns, if any, associated with its use. It is the responsibility of the user of this standard to establish appropriate safety and health practices and determine the applicability of regulatory limitations prior to use.*

2. Referenced Documents

2.1 *ASTM Standards:*²

A153/A153M Specification for Zinc Coating (Hot-Dip) on Iron and Steel Hardware

A510M Specification for General Requirements for Wire Rods and Coarse Round Wire, Carbon Steel (Metric) (Withdrawn 2011)³

A641/A641M Specification for Zinc-Coated (Galvanized) Carbon Steel Wire

B695 Specification for Coatings of Zinc Mechanically Deposited on Iron and Steel

F547 Terminology of Nails for Use with Wood and Wood-Base Materials

F592 Terminology of Collated and Cohered Fasteners and Their Application Tools

F680 Test Methods for Nails

F1575 Test Method for Determining Bending Yield Moment of Nails

3. Terminology

3.1 *Definitions*—The definitions used in this specification are those of common commercial acceptance and usage and also appear in Terminologies **F547** and **F592**.

4. Classification

4.1 The fasteners and their **Table 1** classification are identified as follows:

NOTE 2—The identification of fasteners, classified by style and type (alpha indicators) followed by a dash number (numerical code) based on Tables

¹ This specification is under the jurisdiction of ASTM Committee F16 on Fasteners and is the direct responsibility of Subcommittee F16.05 on Driven and Other Fasteners. Current edition approved Dec. 1, 2013; Sept. 1, 2015. Published February 2014; October 2015. Originally approved in 1995. Last previous edition approved in 2011 as **F1667–11** and **F1667–13**.¹ DOI: 10.1520/F1667-13.10.1520/F1667-15.

² For referenced ASTM standards, visit the ASTM website, www.astm.org, or contact ASTM Customer Service at service@astm.org. For *Annual Book of ASTM Standards* volume information, refer to the standard's Document Summary page on the ASTM website.

³ The last approved version of this historical standard is referenced on www.astm.org.

*A Summary of Changes section appears at the end of this standard

TABLE 1 Classification and Identification Index

Type	Style	Style Identification	Table	
I—Nails (NL)	1. Brads	BR	3	
	2. Barrel	BL	4	
	3. Boat	BTH/BTL	5	
	4. Box A		BXA	6
		Box B	BXB	7
	5. Broom	BM	8	
	6. Casing	CN	9	
	7. Cooler	CL	10	
	8. Sinker	SK	11	
	9. Corker	CK	12	
	10. Common		CMA	13
		Common	CMC	14
		Common	CMS	15
		Common	CMM	16
	11. Concrete	CTS/CTM	17	
	12. Double-headed	DH	18	
	13. Fine	FN	19	
	14. Finishing	FH	20	
	15. Flooring	FL	21	
	16. Lath		LHF	22
			LHH	23
	17. Masonry	MR/MRH	24	
	18. Pallet	PL	25	
	19. Gypsum wallboard		GWS	26
			GWM	27
	20. Roofing		RFA	28
			RFS	29
			RFC	30
			RFL	31
			RFR	32
			RFD	33
21. Shingle		RFNS/RFND	34	
		SHAD/SHAS	35	
	SHSS/SHNSB	36		
22. Siding	SDF/SDC/SDK	37		
23. Slating	SLA/SLC/SLS	38		
24. Rubber heel	RH	39		
25. Underlayment	UL	40		
26. Square-barbed	SB	41		
27. Masonry drive	MD	42		
28. Escutcheon	ES	43		
29. Glulam rivet	GR	44		
30. Post frame	PF	45		
31. Roof Sheathing		RSRS	46	
	Ring Shank			
II—Cut nails (CN)	Common	CM	46	
II—Cut nails (CN)	1. Common	CM	47	
	2. Basket	BK	47	
	3. Basket	BK	48	
	4. Clout	CL	48	
	5. Clout	CL	49	
	6. Trunk	TR	49	
	7. Trunk	TR	50	
	8. Gobblers	GB	50	
	9. Cobblers	CB	51	
	10. Extra-iron clinching	EG	51	
	11. Extra-iron clinching	EC	52	
	12. Hob	HB	52	
	13. Hob	HB	53	
	III—Spikes (SP)	Common	GM	53
III—Spikes (SP)	1. Common	CM	54	
	2. Gutter	GRF/GRO	54	
	3. Gutter	GRF/GRO	55	
	4. Round	RDC/RDF	55	
	5. Round	RDC/RDF	56	
	6. Barge and boat	BB	56	
	7. Barge and boat	BB	57	
	8. Fence	FN	57	
IV—Staples (ST)	Fence	FN	58	
IV—Staples (ST)	1. Fence	FN	58	
	2. Poultry netting	PN	58	
	3. Poultry netting	PN	59	
	4. Flat top crown	FG	59	
	5. Flat top crown	FC	60	
	Flat top crown	FGG	60	
	Flat top crown	FCC	61	

Type	Style	Style Identification	Table
	-4. Round or V crown	RC	61
	4. Round or V crown	RC	62
	-5. Preformed	PG	62
	5. Preformed	PC	63
	-6. Electrical	RE	63
	6. Electrical	RE	64
	-7. Preformed hoop	PH	64
	7. Preformed hoop	PH	65
	-8. Cap	STC	65
	8. Cap	STC	66

**TABLE 2 Bend Angles for Fasteners Using the Test Methods
F680 Bend Test**

Fastener Material	Bend Angle, °
1. Steel wire: (low-carbon, medium-low carbon, medium-carbon) (unhardened)	180
2. Stainless steel wire	180
3. Hardened steel fasteners	20
4. Sheet steel for cut nails, Type II, and cut spikes, Type III	90
5. Copper (min 98 %)	180
6. Copper clad wire (min 20 %)	180
7. Aluminum alloy wire	90
8. Brass wire	180

3–65, identifies dimensions specifically and establishes a PIN (part identifying number) system when preceded by the F1667 ASTM designator of this specification. For example:

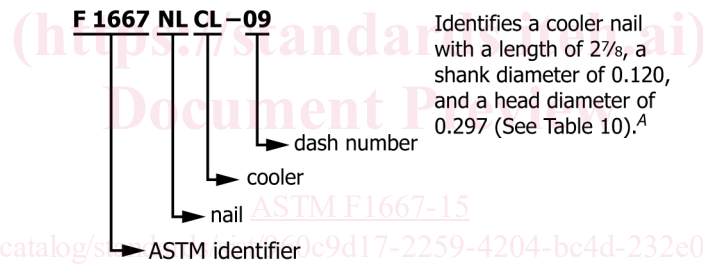

^A All dimensions are given in inches.

4.2 The trade designation, S, pennyweight, used in commercial practice is referenced in Tables 3–64 wherever it applies.

5. Ordering Information

5.1 Orders for driven fasteners under this specification shall include the following information:

- 5.1.1 Quantity or weight;
- 5.1.2 Part identifying number (PIN) or product description (see 4.1 and appropriate table);
- 5.1.3 Special material requirements, if specified, including coatings or finishes;
- 5.1.4 ASTM designation;
- 5.1.5 Packaging requirements;
- 5.1.6 A producer’s or supplier’s certification that the material and the finished fastener are in compliance with this specification, furnished only when specified in the purchase order;
- 5.1.7 Supplementary requirements, if any; and
- 5.1.8 Any additions agreed upon between the purchaser and the supplier.

6. Material Requirements

- 6.1 Steel wire used in the manufacture of driven fasteners shall be of low carbon, medium-low carbon, or medium-high carbon.
- 6.2 Stainless steel wire used in the manufacture of driven fasteners shall be of Types 302, 304, 305, or 316.
- 6.3 Carbon steel wire for the manufacture of hardened steel nails shall be suitable for heat treatment to a minimum hardness of 37 HRC.
- 6.4 Sheet steel used in the manufacture of cut nails (Type II) and cut spikes (Type III) shall be a medium-carbon sheet steel.

6.5 Copper used in the manufacture of driven fasteners shall contain a minimum of 98 % pure copper.

6.6 Copper-clad steel wire used in the manufacture of driven fasteners shall contain not less than 20 % copper by weight. The average thickness of copper on the steel wire shall be not less than 10 % of the radius of the clad wire; the minimum thickness of copper on the steel wire shall be not less than 8 % of the radius of the clad wire.

6.7 Aluminum alloy wire used in the manufacture of fasteners shall conform to Alloy 2024, 5056, 6061, or 6110 and have a minimum ultimate tensile strength of 60 000 psi.

NOTE 3—Smooth shank nails are sometimes chemically treated to remove grease, oil, and foreign matter and to roughen the surface microscopically. Mechanically deformed nails are sometimes cleaned to remove grease and foreign matter.

6.8 Brass wire used in the manufacture of fasteners shall be of good commercial quality suitable for the purpose.

7. Physical Properties

7.1 *Ductility*—The fasteners shall be sufficiently ductile to withstand cold bending without fracture, as specified in Table 2 for various materials used in the manufacture of fasteners utilizing the conventional bend test described in Test Methods F680. Mandrel diameter used in this test shall not exceed nail/wire diameter. The cold bend test shall not apply to unhardened nails with deformed shanks.

7.2 *Tensile Strength*—Finished driven fasteners are not normally subject to tension testing. However, the wire or sheet used to manufacture the fastener is tested as required for control in the production process during manufacture.

7.3 *Number per pound*—Number per pound figures are not requirements. Number per pound varies (1) as actual dimensions vary within tolerance ranges, (2) between bright and coated nails, and (3) with zinc coating thickness for galvanized nails. No tolerances have been established for these figures. They are for reference only and shall not be used as product acceptance/rejection criteria.

8. Dimensions and Tolerances

8.1 Nominal dimensions of nails and spikes shall be as shown in Tables 3–56. The following dimensional designations shall apply:

S = trade designation (reference in penny weight),
L = length, in.,
H = head diameter or width, in.,
D = shank diameter, in.,
B = head separation, in. (Table 18), and
No./lb = approximate count per pound.

8.1.1 The lengths, *L*, of nails and spikes with flat heads or parallel shoulders under the head shall be measured from under the head or shoulder to the tip of the point. All other nails and spikes shall be measured overall.

8.1.2 The diameter, *D*, of smooth shank nails and spikes shall be measured away from the gripper marks. The diameter, *D*, of formed or deformed shanks shall be measured before deformation, or, if specified, the thread crest diameter after deformation, or both. All diameter dimensions shall be taken prior to the application of or after the removal of any coatings or finish.

8.2 Tolerances on Nominal Dimensions for Nails and Spikes:

8.2.1 Length tolerances shall be $\pm 1/32$ in. for lengths up to and including 1 in.; $\pm 1/16$ in. for lengths over 1 in., up to and including $2\frac{1}{2}$ in.; $\pm 3/32$ for lengths over $2\frac{1}{2}$ in., up to and including 7 in.; and $\pm 1/8$ in. for all lengths over 7 in.

8.2.2 Shank diameter tolerances shall be ± 0.002 in. for diameters smaller than 0.076 in. and ± 0.004 in. for diameters 0.076 in. and larger.

8.2.3 Head Diameter Tolerances:

8.2.3.1 *Hand Driven*—Tolerances on head diameters of roofing nails shall be +0, –10 % of the nominal head diameter (the mean of two readings 90° apart). For other brads, nails, and spikes, the tolerance shall be ± 10 % of the nominal head diameter (individual measurement). The difference in diameter across the long axis of a roofing nail shall not exceed that across the short axis by more than 20 %. For other brads, nails, and spikes, the difference in diameter across the long axis shall not exceed that across the short axis by more than 10 %. A fillet shall be provided under the head if not otherwise specified.

8.2.3.2 *Power Driven*—Tolerances on head diameters of power-driven nails shall comply with the manufacturer's specifications and shall be suitable for use in the make and model of the tool specified.

8.3 Nominal dimensions of staples shall be as shown in Tables 57–65, and the following dimensional designations shall apply:

8.3.1 Hand Tool–Driven Nominal Dimensions:

L = leg length, inside, in.,
D = round leg diameter, in.,
C = crown width, inside, in., and

No./lb = approximate count per pound.

8.3.2 Power Tool–Driven Nominal Dimensions:

D = round leg diameter, in.,
L = leg length, outside, in.,
T = leg thickness, in. (see Tables 59 and 60),
W = leg width, in. (see Tables 59 and 60),
C = crown width, outside, in., and
G = steel wire gage.

8.4 Tolerances on Nominal Dimensions for Staples:

8.4.1 Leg length, *L*, tolerances shall be $+1/32$, $-1/64$ in. for both hand tool–driven and power tool–driven staples.

8.4.2 Diameter tolerances for hand tool–driven round staples shall be ± 0.002 in. for diameters smaller than 0.076 in. and ± 0.004 in. for diameters 0.076 in. and larger.

8.4.3 Thickness and width tolerances on power-driven staples shall comply with the manufacturer’s specification and shall be suitable for use in the make and model tool specified (see Tables 59 and 60).

8.4.4 Crown width tolerances are $\pm 1/32$ in. unless otherwise specified.

8.5 *Nominal Dimensions for Cut Nails, Type II*—Unless otherwise specified, cut nails shall be sheared from medium carbon sheet steel and shall have a wedge-shaped shank with a sheared square point end narrower than the upset head end. The designation *T* in Tables 46–51 refers to sheet thickness in finished product. Other designations shall be the same as those for nails in 8.1.

8.6 When gage is used for a nominal diameter dimension in the application of this specification, it shall be in accordance with the decimal equivalents as shown in Specification **A510M**, unless otherwise specified.

9. Workmanship

9.1 Fasteners covered by this specification shall be true to shape, well-finished, free from imperfections, clean, and free of corrosion. Mechanically driven collated items shall be uniform and aligned properly in their assembled form for use in power tools.

10. Protective Coatings and Finishes

10.1 Zinc Coating:

10.1.1 Driven fasteners required to be zinc coated shall be cut and formed from hot-dip, hard-wiped, galvanized steel wire, electrogalvanized steel wire, or zinc flake/chromate dispersion-coated steel wire; or they shall be cut from uncoated (bright) steel wire and shall be hot-dip galvanized, electrodeposited zinc coated, mechanically deposited zinc coated, or zinc flake/chromate dispersion coated after forming. Power-driven staples are not normally zinc coated after forming.

10.1.2 Hot-dip galvanized or electrogalvanized steel wire for the manufacture of fasteners shall have a coating weight in accordance with Specification **A641/A641M**, Supplementary Requirements, Class 1.

10.1.3 Hot-dip galvanized steel fasteners coated after forming shall have a coating weight in accordance with Specification **A153/A153M**, Class D, when a heavier coating for exterior use is specified. If not otherwise specified, the coating weight shall be in accordance with Specification **A641/A641M**, Supplementary Requirements, Class 1.

10.1.4 Mechanically deposited zinc coatings applied to fasteners after forming shall have a thickness in accordance with Specification **B695**, Class 40, unless otherwise specified.

10.2 Other Coatings and Finishes (When Specified):

10.2.1 Cement coating shall be applied by tumbling, mechanical dispensing device, or immersion in resin or other similar material and shall not be tacky or gummy. Cement coatings on power-driven fasteners shall be uniform and applied before, during, or after the fasteners are cohered into strips, clips, or coils.

NOTE 4—Cement coatings increase the holding strength in withdrawal of a driven fastener, depending on the fastener size, amount of cement coating applied, and method of driving.

10.2.2 Chemical etching shall remove the polish of fabrication and roughen the surface microscopically.

10.2.3 Blued nails shall be heated to form a thin, colored oxide on the surface.

10.2.4 Miscellaneous finishes, such as tin plating, liquor, brass plating, copper plating, phosphate coating, or oil coating shall be applied.

10.3 Altered Shapes and Deformations:

10.3.1 Mechanically formed or deformed nail shanks shall have barbs, flutes, threads, or angular serrations formed onto the wire from which the nail is manufactured. Mechanically deformed shanks shall have vertical or helical flutes or screw-type or annular (ring)-type deformations rolled onto the shank. Symmetrical helical shank deformations shall be obtained by twisting square wire. The deformations shall pass entirely around the shank body, resulting in expanded ridges and depressions. Interruptions in shank deformation to facilitate attachment of materials for collating nails is permitted.

10.3.2 Mechanically formed or deformed nail heads shall be round or T-headed; or they shall be altered round for suitable use in a given make and model of a power-driving fastening system.

10.3.3 Staples manufactured for intended use in power tools shall comply with the tool manufacturer’s specification or Type IV, Style 3 (Table 59 or Table 60).

11. Certification

11.1 When specified in the purchase order, a producer’s or supplier’s certification shall be furnished to the purchaser, indicating that the fasteners are in compliance with this specification and the purchase order.

12. Packaging and Package Marking

12.1 Unless otherwise specified, fasteners shall be in substantial commercial containers of the type, size, and kind commonly used for the purpose, so constructed as to preserve the contents in good condition and to ensure acceptance and safe delivery by common or other carriers to the point of delivery. In addition, the containers shall be so made that the contents can be removed partially without destroying the container’s ability to serve as a receptacle for the remainder of the contents.

12.2 When specified, individual packages and shipping containers shall be marked with the part-identifying number and type, length, diameter (or gage, as applicable) of the fastener, the name of the manufacturer or distributor, and the quantity or net weight.

13. Keywords

13.1 diameter; driven fasteners; head; length; nails; point; spikes; staples

TABLE 3 Type I, Style 1—Brads^A

NOTE 1—Steel wire, brad head, diamond point, round smooth shank, bright finish. When specified, brads shall have a modified brad head with a blunt or chiseled point for use with mechanical drivers.

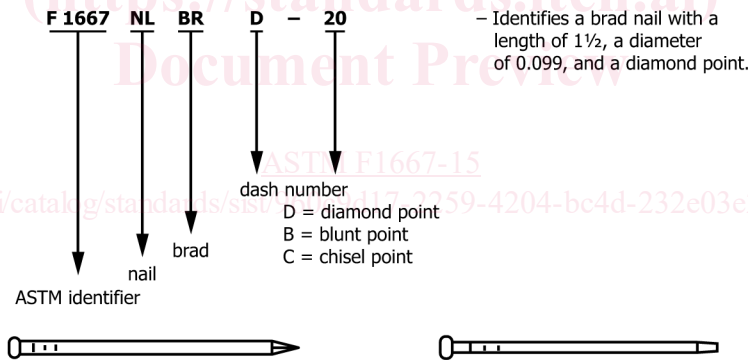

Dash No.	L	D	S	No./lb	Dash No.	L	D	S	No./lb
01	3/8	0.035	...	9520	21	1 3/4	0.062	...	670
02	1/2	0.035	...	7060	22	1 3/4	0.080	...	400
03	1/2	0.048	...	3990	23	1 3/4	0.099	5d	270
04	5/8	0.035	...	5680	24	2	0.062	...	580
05	5/8	0.048	...	3200	25	2	0.080	...	350
06	3/4	0.035	...	4800	26	2	0.113	6d	180
07	3/4	0.048	...	2620	27	2 1/4	0.080	...	320
08	3/4	0.062	...	1550	28	2 1/4	0.113	7d	160
09	7/8	0.035	...	4220	29	2 1/2	0.080	...	290
10	7/8	0.048	...	2220	30	2 1/2	0.131	8d	110
11	7/8	0.062	...	1280	31	2 3/4	0.131	9d	97
12	1	0.054	...	1500	32	3	0.148	10d	70
13	1	0.062	...	1120	33	3 1/4	0.148	12d	65
14	1	0.072	...	904	34	3 1/2	0.162	16d	50
15	1 1/4	0.054	...	1210	35	4	0.192	20d	31
16	1 1/4	0.062	...	940	36	4 1/2	0.207	30d	24
17	1 1/4	0.080	3d	560	37	5	0.225	40d	18
18	1 1/2	0.054	...	1040	38	5 1/2	0.244	50d	14
19	1 1/2	0.080	...	470	39	6	0.262	60d	11
20	1 1/2	0.099	4d	320

^AAll dimensions are given in inches.

TABLE 4 Type I, Style 2—Barrel Nails^A

NOTE 1—Steel wire, flat head, diamond point, round smooth shank, bright, zinc or cement coated as specified.

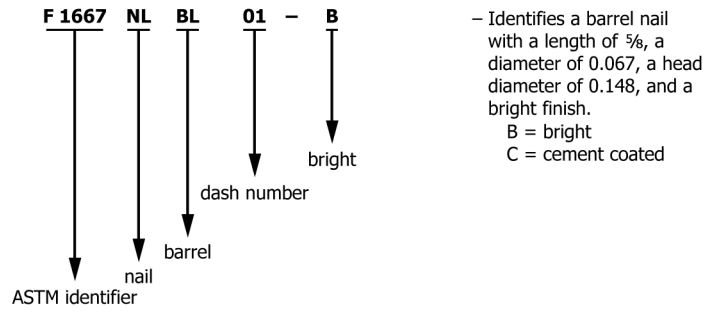

- Identifies a barrel nail with a length of 5/8, a diameter of 0.067, a head diameter of 0.148, and a bright finish.
 B = bright
 C = cement coated

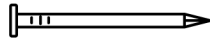

Dash No.	L	D	H	No./lb	Dash No.	L	D	H	No./lb
01	5/8	0.067	0.148	1.550	05	1 1/8	0.076	0.177	670
02	3/4	0.067	0.148	1.300	06	1 1/4	0.080	0.188	540
03	7/8	0.076	0.177	850	07	1 3/8	0.092	0.219	380
04	1	0.076	0.177	750	08	1 1/2	0.092	0.219	350

^AAll dimensions are given in inches.

TABLE 5 Type I, Style 3—Boat nails^A

NOTE 1—Steel wire, oval countersunk head, chisel point, round smooth shank, bright or zinc coated as specified.

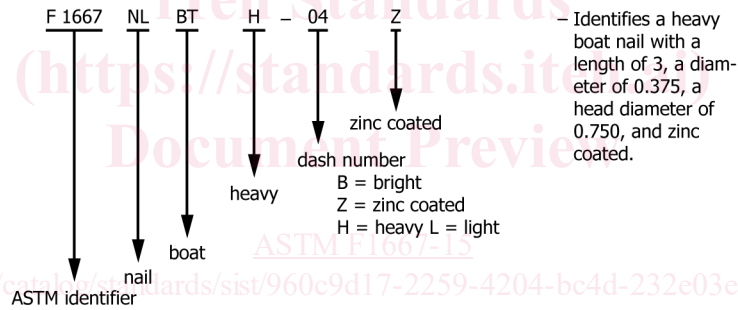

- Identifies a heavy boat nail with a length of 3, a diameter of 0.375, a head diameter of 0.750, and zinc coated.
 B = bright
 Z = zinc coated
 H = heavy L = light

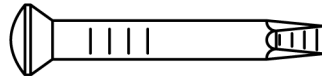

F 1667 NLBTL						F 1667 NLBTH					
Dash No.	S	L	D	H	No./lb	Dash No.	S	L	D	H	No./lb
01	4d	1 1/2	0.188	0.406	82	01	4d	1 1/2	0.250	0.500	47
02	6d	2	0.188	0.406	62	02	6d	2	0.250	0.500	36
03	8d	2 1/2	0.188	0.406	50	03	8d	2 1/2	0.250	0.500	29
04	10d	3	0.250	0.500	24	04	10d	3	0.375	0.750	11
05	12d	3 1/4	0.250	0.500	22	05	12d	3 1/4	0.375	0.750	10
06	16d	3 1/2	0.250	0.500	20	06	16d	3 1/2	0.375	0.750	9
07	20d	4	0.250	0.500	18	07	20d	4	0.375	0.750	8

^AAll dimensions are given in inches.

TABLE 6 Type I, Style 4A—Box Nails^A

NOTE 1—Steel wire, flat head, diamond point, round, barbed or smooth shank, bright or cement coated as specified. When specified, box nails shall have an altered or T-head with a diamond, blunt, or chisel point for use with mechanical drivers.

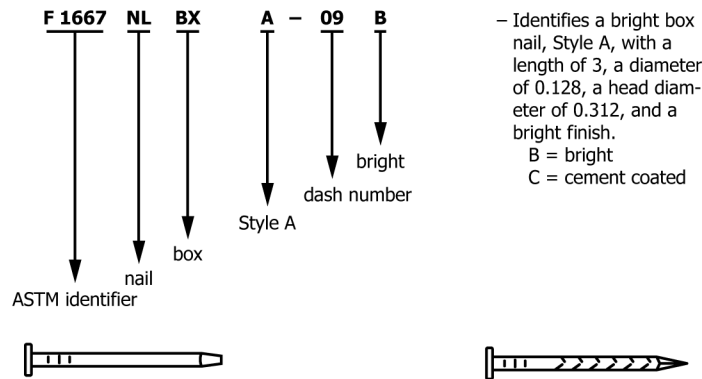

F 1667 NLBXA											
Dash No.	S	L	D	H	No./lb	Dash No.	S	L	D	H	No./lb
01	2d	1	0.067	0.188	940	08	9d	2¾	0.113	0.297	120
02	3d	1¼	0.076	0.219	590	09	10d	3	0.128	0.312	90
03	4d	1½	0.080	0.219	450	10	12d	3¼	0.128	0.312	83
04	5d	1¾	0.080	0.219	390	11	16d	3½	0.135	0.344	69
05	6d	2	0.099	0.266	220	12	20d	4	0.148	0.375	50
06	7d	2¼	0.099	0.266	200	13	30d	4½	0.148	0.375	45
07	8d	2½	0.113	0.297	140	14	40d	5	0.162	0.406	34

^AAll dimensions are given in inches.

iTeh Standards

TABLE 7 Type I, Style 4B—Box Nails^A

NOTE 1—Steel wire, flat head, diamond point, round smooth shank, cement coated.

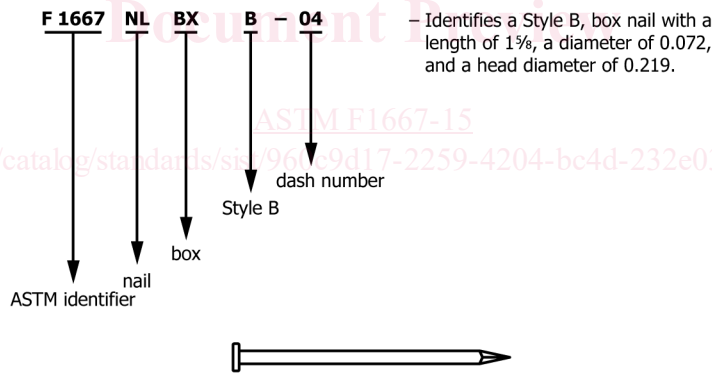

F 1667 NLBxB											
Dash No.	S	L	D	H	No./lb	Dash No.	S	L	D	H	No./lb
01	2d	1	0.058	0.172	1250	06	7d	2½	0.086	0.250	280
02	3d	1⅛	0.062	0.188	980	07	8d	2¾	0.099	0.266	190
03	4d	1⅜	0.067	0.203	680	08	9d	2⅝	0.099	0.266	170
04	5d	1⅝	0.072	0.219	510	09	10d	2⅞	0.113	0.297	120
05	6d	1⅞	0.086	0.250	315

^AAll dimensions are given in inches.

TABLE 8 Type I, Style 5—Broom Nails^A

NOTE 1—Steel wire, flat or star head, diamond point, round smooth shank, bright finish, as specified.

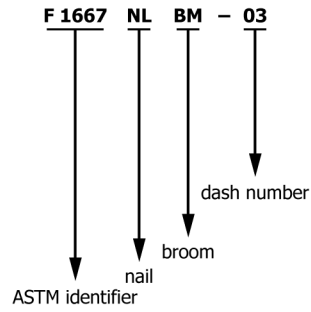

– Identifies a broom nail with a length of $\frac{3}{4}$, a diameter of 0.072, and a head diameter of 0.203.

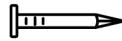

Dash No.	<i>L</i>	<i>D</i>	<i>H</i>	No./lb
01	$\frac{5}{8}$	0.072	0.203	1480
02	$\frac{5}{8}$	0.080	0.219	990
03	$\frac{3}{4}$	0.072	0.203	1170
04	$\frac{3}{4}$	0.080	0.219	840

^AAll dimensions are given in inches.

TABLE 9 Type I, Style 6—Casing Nails^A

NOTE 1—Steel wire, flat countersunk cupped head, diamond point, round smooth shank, bright finish.

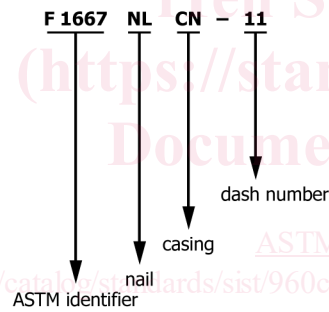

– Identifies a casing nail with a length of $3\frac{1}{2}$, a diameter of 0.135, and a head diameter of 0.177.

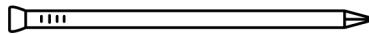

Dash No.	<i>S</i>	<i>L</i>	<i>D</i>	<i>H</i>	No./lb	Dash No.	<i>S</i>	<i>L</i>	<i>D</i>	<i>H</i>	No./lb
01	2d	1	0.067	0.099	1090	07	8d	2½	0.113	0.155	150
02	3d	1¼	0.076	0.113	650	08	9d	2¾	0.113	0.155	135
03	4d	1½	0.080	0.120	490	09	10d	3	0.128	0.170	95
04	5d	1¾	0.080	0.120	415	10	12d	3¼	0.128	0.170	90
05	6d	2	0.099	0.142	245	11	16d	3½	0.135	0.177	75
06	7d	2¼	0.099	0.142	215

^AAll dimensions are given in inches.

TABLE 10 Type I, Style 7—Cooler Nails^A

NOTE 1—Steel wire, flat head, diamond point, round smooth shank, cement coated. When specified, coolers shall have an altered or T-head for use with mechanical drivers.

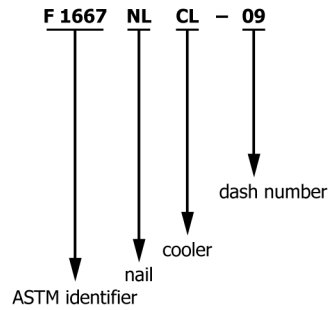

– Identifies a cooler nail with a length of 2⁷/₈, a diameter of 0.120, and a head diameter of 0.297.

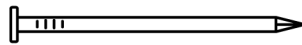

Dash No.	S	L	D	H	No./lb	Dash No.	S	L	D	H	No./lb
01	2d	1	0.062	0.172	1110	06	7d	2 ¹ / ₈	0.099	0.266	210
02	3d	1 ¹ / ₈	0.067	0.188	840	07	8d	2 ³ / ₈	0.113	0.281	140
03	4d	1 ³ / ₈	0.080	0.219	490	08	9d	2 ⁵ / ₈	0.113	0.281	130
04	5d	1 ⁵ / ₈	0.086	0.234	370	09	10d	2 ⁷ / ₈	0.120	0.297	100
05	6d	1 ⁷ / ₈	0.092	0.250	280

^AAll dimensions are given in inches.

TABLE 11 Type I, Style 8—Sinker Nails^A

NOTE 1—Steel wire, flat countersunk head, diamond point, round smooth shank, bright or cement coated. When specified, sinkers shall have an altered or T-head for use with mechanical drivers.

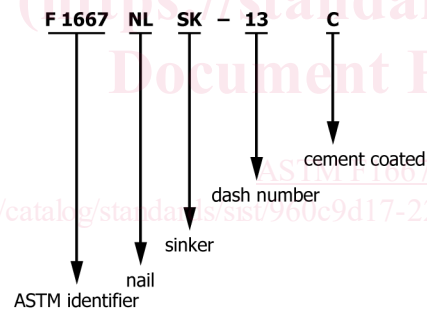

– Identifies a sinker nail with a length of 5³/₄, a diameter of 0.244, a head diameter of 0.500, and cement coated.
B = bright
C = cement coated

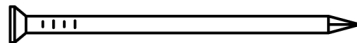

Dash No.	S	L	D	H	No./lb	Dash No.	S	L	D	H	No./lb
01	3d	1 ¹ / ₈	0.067	0.172	940	08	12d	3 ¹ / ₈	0.135	0.312	81
02	4d	1 ³ / ₈	0.080	0.203	530	09	16d	3 ¹ / ₄	0.148	0.344	64
03	5d	1 ⁵ / ₈	0.086	0.219	390	10	20d	3 ³ / ₄	0.177	0.375	40
04	6d	1 ⁷ / ₈	0.092	0.234	290	11	30d	4 ¹ / ₄	0.192	0.406	30
05	7d	2 ¹ / ₈	0.099	0.250	220	12	40d	4 ³ / ₄	0.207	0.438	23
06	8d	2 ³ / ₈	0.113	0.266	150	13	60d	5 ³ / ₄	0.244	0.500	14
07	10d	2 ⁷ / ₈	0.120	0.281	110

^AAll dimensions are given in inches.

TABLE 12 Type I, Style 9—Corker Nails^A

NOTE 1—Steel wire, flat countersunk head, diamond point, round smooth shank, cement coated. When specified, corkers shall have an altered or T-head for use with mechanical drivers.

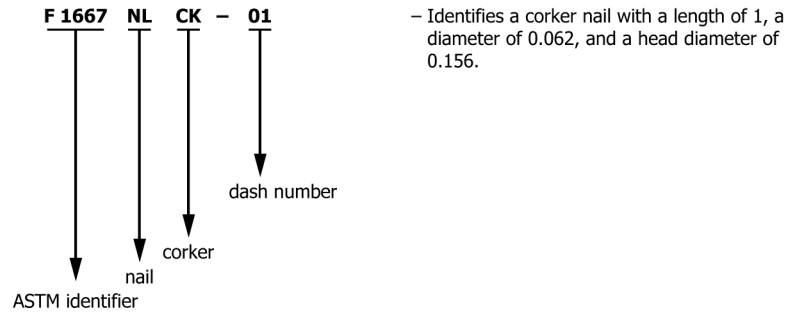

– Identifies a corker nail with a length of 1, a diameter of 0.062, and a head diameter of 0.156.

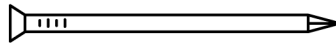

Dash No.	S	L	D	H	No./lb	Dash No.	S	L	D	H	No./lb
01	2d	1	0.062	0.156	1220	09	10d	27/8	0.135	0.312	89
02	3d	1¼	0.072	0.188	720	10	12d	3½	0.135	0.312	81
03	4d	1½	0.086	0.219	420	11	16d	3¾	0.148	0.344	62
04	5d	1⅝	0.086	0.219	320	12	20d	3⅞	0.177	0.375	38
05	6d	1⅞	0.099	0.250	250	13	30d	4¾	0.192	0.406	29
06	7d	2⅛	0.099	0.250	220	14	40d	4⅞	0.207	0.438	22
07	8d	2¾	0.120	0.281	130	15	50d	5⅞	0.226	0.469	17
08	9d	2⅞	0.120	0.281	120	16	60d	5⅞	0.244	0.500	13

^AAll dimensions are given in inches.

TABLE 13 Type I, Style 10—Common Nails^A

NOTE 1—Aluminum alloy wire, flat head, diamond point, round smooth shank, or, when specified, square barbed shank.

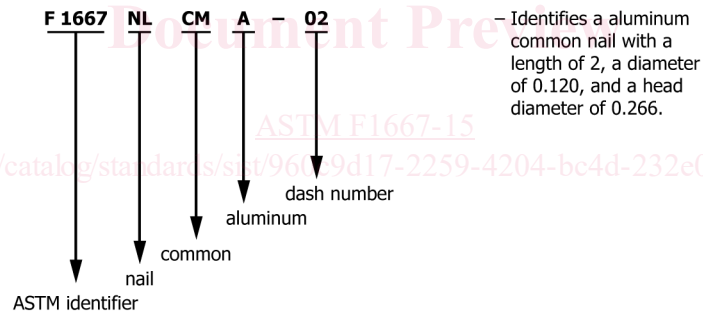

– Identifies a aluminum common nail with a length of 2, a diameter of 0.120, and a head diameter of 0.266.

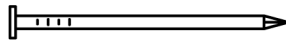

F 1667 NLCMA											
Dash No.	S	L	D	H	No./lb	Dash No.	S	L	D	H	No./lb
01	4d	1½	0.099	0.250	830	04	10d	3	0.162	0.312	170
02	6d	2	0.120	0.266	430	05	16d	3½	0.177	0.344	120
03	8d	2½	0.148	0.281	220	06	20d	4	0.199	0.406	78

^AAll dimensions are given in inches.

TABLE 14 Type I, Style 10—Common Nails^A

NOTE 1—Copper wire, flat head, diamond point, round smooth shank.

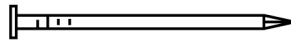
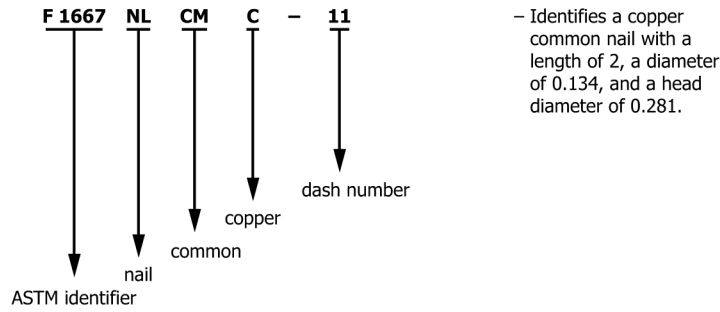

F 1667 NLCMC									
Dash No.	L	D	H	No./lb	Dash No.	L	D	H	No./lb
01	5/8	0.065	0.156	1380	10	2	0.120	0.266	130
02	3/4	0.065	0.156	1160	11	2	0.134	0.281	...
03	3/4	0.072	0.172	960	12	2 1/2	0.134	0.281	86
04	7/8	0.072	0.172	810	13	3	0.148	0.312	56
05	1	0.072	0.172	700	14	3 1/2	0.165	0.344	40
06	1 1/4	0.083	0.203	420	15	4	0.203	0.406	23
07	1 1/2	0.109	0.250	210	16	4 1/2	0.220	0.438	18
08	1 3/4	0.109	0.250	180	17	5	0.238	0.469	14
09	1 3/4	0.120	0.266	140	18	6	0.284	0.531	8

^AAll dimensions are given in inches.

TABLE 15 Type I, Style 10—Common Nails^A

NOTE 1—Steel wire, flat head, diamond point, round smooth shank, bright, zinc or cement coated as specified.

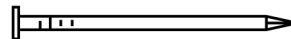
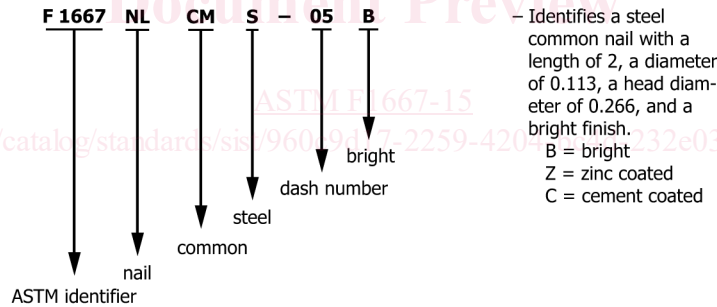

F 1667 NLCMS											
Dash No.	S	L	D	H	No./lb	Dash No.	S	L	D	H	No./lb
01	2d	1	0.072	0.172	850	09	10d	3	0.148	0.312	66
02	3d	1 1/4	0.080	0.203	540	10	12d	3 1/4	0.148	0.312	61
03	4d	1 1/2	0.099	0.250	290	11	16d	3 1/2	0.162	0.344	47
04	5d	1 3/4	0.099	0.250	250	12	20d	4	0.192	0.406	30
05	6d	2	0.113	0.266	170	13	30d	4 1/2	0.207	0.438	23
06	7d	2 1/4	0.113	0.266	150	14	40d	5	0.226	0.469	17
07	8d	2 1/2	0.131	0.281	100	15	50d	5 1/2	0.244	0.500	14
08	9d	2 3/4	0.131	0.281	92	16	60d	6	0.262	0.531	11

^AAll dimensions are given in inches.

TABLE 17 Type I, Style 11—Concrete Nails^A

NOTE 1—Hardened steel, flat countersunk head, diamond point, smooth or mechanically deformed shank formed from round or square stock, as specified, bright finish.

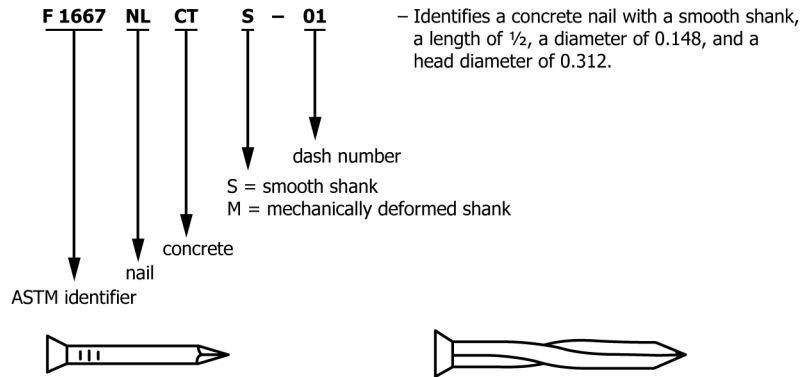

F 1667 NLCTS				
Dash No.	L	D	H	No./lb
01	1/2	0.148	0.312	450
02	5/8	0.148	0.312	350
03	3/4	0.148	0.312	290
04	7/8	0.148	0.312	250
05	1	0.148	0.312	210

F 1667 NLCTM									
Dash No.	L	D	H	No./lb	Dash No.	L	D	H	No./lb
01	3/4	0.181	0.284	240	05	2	0.181	0.284	93
02	1	0.181	0.284	204	06	2 1/2	0.181	0.284	68
03	1 1/2	0.181	0.284	116	07	2 3/4	0.181	0.284	60
04	1 3/4	0.181	0.284	112	08	3	0.181	0.284	52

^AAll dimensions are given in inches.

TABLE 18 Type I, Style 12—Double-Headed Nails^A

NOTE 1—Steel wire, flat heads, diamond point, round smooth shank, bright finish or cement coated.

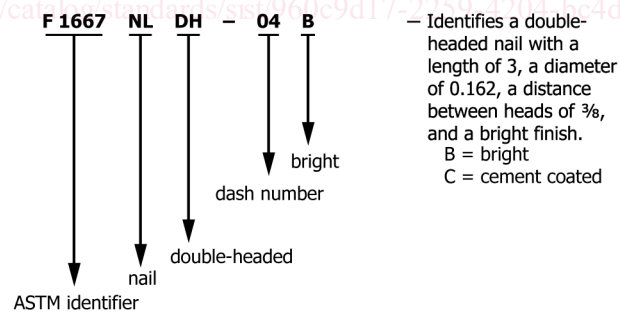

Dash No.	S	L	D	B	No./lb	Dash No.	S	L	D	B	No./lb
01	6d	1 3/4	0.113	1/4	160	04	16d	3	0.162	3/8	45
02	8d	2 1/4	0.131	1/4	90	05	20d	3 1/2	0.192	3/8	28
03	10d	2 3/4	0.148	5/16	59	06	30d	4	0.207	7/16	22

^AAll dimensions are given in inches.