



Standard Test Methods for Notched Bar Impact Testing of Metallic Materials¹

This standard is issued under the fixed designation E23; the number immediately following the designation indicates the year of original adoption or, in the case of revision, the year of last revision. A number in parentheses indicates the year of last reapproval. A superscript epsilon (ϵ) indicates an editorial change since the last revision or reapproval.

This standard has been approved for use by agencies of the U.S. Department of Defense.

1. Scope*

1.1 These test methods describe notched-bar impact testing of metallic materials by the Charpy (simple-beam) test and the Izod (cantilever-beam) test. They give the requirements for: test specimens, test procedures, test reports, test machines (see [Annex A1](#)) verifying Charpy impact machines (see [Annex A2](#)), optional test specimen configurations (see [Annex A3](#)), designation of test specimen orientation (see Terminology [E1823](#)), and determining the percent of shear fracture on the surface of broken impact specimens (see [Annex A4](#)). In addition, information is provided on the significance of notched-bar impact testing (see [Appendix X1](#)), and methods of measuring the center of strike (see [Appendix X2](#)).

1.2 These test methods do not address the problems associated with impact testing at temperatures below $-196\text{ }^{\circ}\text{C}$ (77 K).

1.3 The values stated in SI units are to be regarded as standard. No other units of measurement are included in this standard.

1.3.1 *Exception*—Section [8](#) and [Annex A4](#) provide inch-pound units for information only.

1.4 *This standard does not purport to address all of the safety concerns, if any, associated with its use. It is the responsibility of the user of this standard to establish appropriate safety and health practices and determine the applicability of regulatory limitations prior to use.* Specific precautionary statements are given in Section [5](#).

2. Referenced Documents

2.1 ASTM Standards:²

[B925 Practices for Production and Preparation of Powder Metallurgy \(PM\) Test Specimens](#)

¹ These test methods are under the jurisdiction of ASTM Committee [E28](#) on Mechanical Testing and are the direct responsibility of Subcommittee [E28.07](#) on Impact Testing.

Current edition approved April 1, 2016. Published May 2016. Originally approved in 1933. Last previous edition approved 2016 as E23 – 16. DOI: 10.1520/E0023-16A.

² For referenced ASTM standards, visit the ASTM website, www.astm.org, or contact ASTM Customer Service at service@astm.org. For *Annual Book of ASTM Standards* volume information, refer to the standard's Document Summary page on the ASTM website.

[E177 Practice for Use of the Terms Precision and Bias in ASTM Test Methods](#)

[E691 Practice for Conducting an Interlaboratory Study to Determine the Precision of a Test Method](#)

[E1823 Terminology Relating to Fatigue and Fracture Testing](#)

[E2298 Test Method for Instrumented Impact Testing of Metallic Materials](#)

3. Summary of Test Method

3.1 The essential features of an impact test are: a suitable specimen (specimens of several different types are recognized), a set of anvils, and specimen supports on which the test specimen is placed to receive the blow of the moving mass, a moving mass that has sufficient energy to break the specimen placed in its path, and a device for measuring the energy absorbed by the broken specimen.

4. Significance and Use

4.1 These test methods of impact testing relate specifically to the behavior of metal when subjected to a single application of a force resulting in multi-axial stresses associated with a notch, coupled with high rates of loading and in some cases with high or low temperatures. For some materials and temperatures the results of impact tests on notched specimens, when correlated with service experience, have been found to predict the likelihood of brittle fracture accurately. Further information on significance appears in [Appendix X1](#).

5. Precautions in Operation of Machine

5.1 Safety precautions should be taken to protect personnel from the swinging pendulum, flying broken specimens, and hazards associated with specimen warming and cooling media.

6. Apparatus

6.1 General Requirements:

6.1.1 The testing machine shall be a pendulum type of rigid construction.

6.1.2 The testing machine shall be designed and built to conform with the requirements given in [Annex A1](#).

6.2 Inspection and Verification:

6.2.1 Inspection procedures to verify impact machines directly are provided in [A2.2](#) and [A2.3](#). The items listed in [A2.2](#) must be inspected annually.

*A Summary of Changes section appears at the end of this standard

6.2.2 The procedures to verify Charpy machines indirectly, using verification specimens, are given in A2.4. Charpy impact machines must be verified directly and indirectly annually.

7. Test Specimens

7.1 Configuration and Orientation:

7.1.1 Specimens shall be taken from the material as specified by the applicable specification.

7.1.2 The type of specimen chosen depends largely upon the characteristics of the material to be tested. A given specimen may not be equally satisfactory for soft nonferrous metals and hardened steels; therefore, many types of specimens are recognized. In general, sharper and deeper notches are required to distinguish differences in very ductile materials or when using low testing velocities.

7.1.3 The specimens shown in Figs. 1 and 2 are those most widely used and most generally satisfactory. They are particularly suitable for ferrous metals, excepting cast iron.³ The Charpy specimen designations are V-notch and U-notch.

NOTE 1—Keyhole notch specimen is similar to U-notch, except the notch width is 1.6 mm or less.

³ Report of Subcommittee XV on Impact Testing of Committee A-3 on Cast Iron, Proceedings, ASTM, Vol 33 Part 1, 1933.

7.1.4 The specimens commonly found suitable for powder metallurgy materials are shown in Figs. 3 and 4. Powder metallurgy impact test specimens shall be produced following the procedure in Practices B925. The impact test results of these materials are affected by specimen orientation. Therefore, unless otherwise specified, the position of the specimen in the machine shall be such that the pendulum will strike a surface that is parallel to the compacting direction. For powder metallurgy materials the impact test results are reported as unnotched absorbed impact energy.

7.1.5 Sub-size and supplementary specimen recommendations are given in Annex A3.

7.2 Specimen Machining:

7.2.1 When heat-treated materials are being evaluated, the specimen shall be finish machined, including notching, after the final heat treatment, unless it can be demonstrated that the impact properties of specimens machined before heat treatment are identical to those machined after heat treatment.

7.2.2 Notches shall be smoothly machined, but polishing has proven generally unnecessary. However, since variations in notch dimensions will seriously affect the results of the tests, adhering to the tolerances given in Fig. 1 is necessary (Appendix X1.2 illustrates the effects from varying notch dimensions on V-notch specimens).

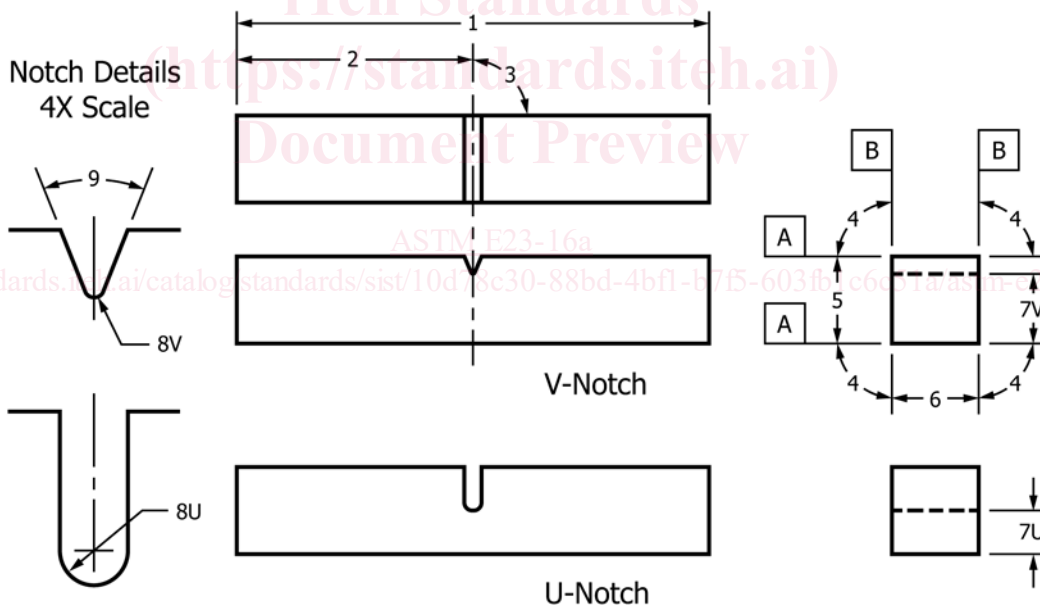

ID Number	Description	Dimension	Tolerance
1	Length of specimen	55 mm	+0/-2.5 mm
2	Centering of notch		±1 mm
3	Notch length to edge	90°	±2°
4	Adjacent sides angle	90°	±0.17°
5	Width	10 mm	±0.075 mm
6	Thickness	10 mm	±0.075 mm
7V	Ligament length, Type V	8 mm	±0.025 mm
7U	Ligament length, Type U	5 mm	±0.075 mm
8V	Radius of notch, Type V	0.25 mm	±0.025 mm
8U	Radius of notch, Type U	1 mm	±0.025 mm
9	Angle of notch	45°	±1°
A	Surface finish requirements	2 μm (Ra)	≤
B	Surface finish requirements	4 μm (Ra)	≤

FIG. 1 Charpy (Simple-Beam) Impact Test Specimens, V-Notch and U-Notch

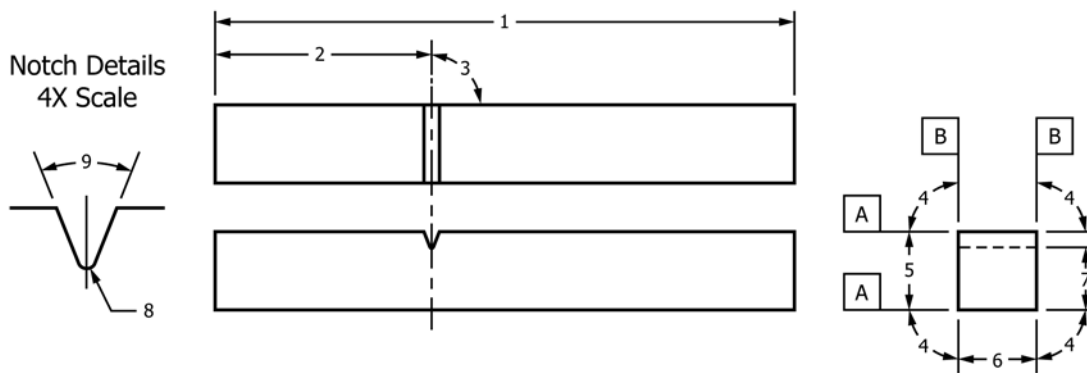

ID Number	Description	Dimension	Tolerance
1	Length of specimen	75 mm	+0/-2.5 mm
2	Notch to top	28 mm	
3	Notch length to edge	90°	±2°
4	Adjacent sides angle	90°	±0.17°
5	Width	10 mm	±0.025 mm
6	Thickness	10 mm	±0.025 mm
7	Ligament length	8 mm	±0.025 mm
8	Radius of notch	0.25 mm	±0.025 mm
9	Angle of notch	45°	±1°
A	Surface finish requirement	2 μm (Ra)	≦
B	Surface finish requirement	4 μm (Ra)	≦

FIG. 2 Izod (Cantilever-Beam) Impact Test Specimen

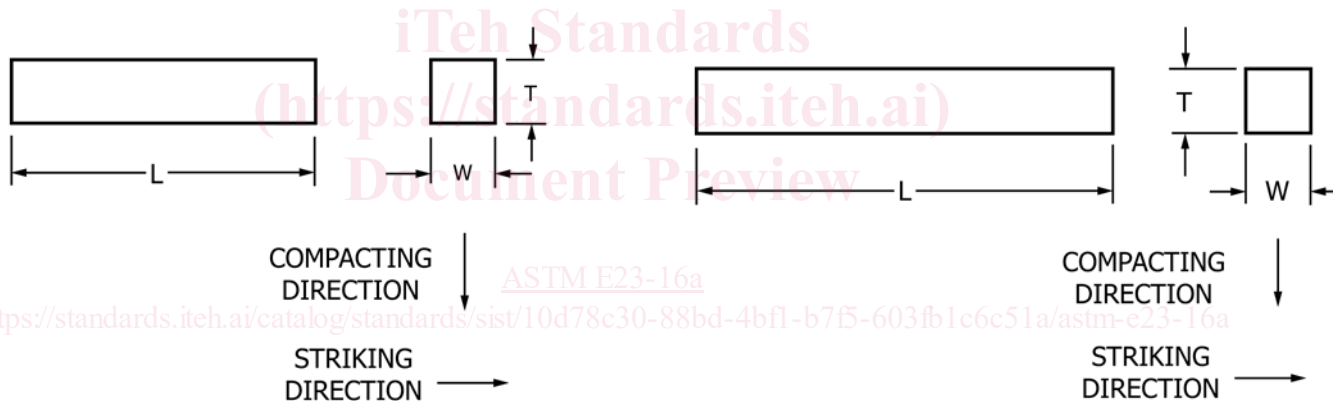

	Dimensions mm
L- Overall Length	55.0 ± 1.0
W-Width	10.00 ± 0.13
T-Thickness	10.00 ± 0.13

NOTE 1—Adjacent sides shall be at 90° ± 10 min.

FIG. 3 Unnotched Charpy (Simple Beam) Impact Test Specimen for Metal Powder Structural Materials

NOTE 2—In keyhole notch specimens, the round hole shall be carefully drilled with a slow feed rate. The slot may be cut by any feasible method, but care shall be exercised in cutting the slot to ensure that the surface of the drilled hole opposite the slot is not damaged.

7.2.3 Identification marks shall only be placed in the following locations on specimens: either of the 10-mm square ends; the side of the specimen that faces up when the specimen is positioned in the anvils (see Note 3); or the side of the specimen opposite the notch. No markings, on any side of the specimen, shall be within 10 mm of the center line of the notch. Permanent markers, laser engraving, scribes, electrostatic

	Dimensions mm
L- Overall Length	75.0 ± 1.5
W-Width	10.00 ± 0.13
T-Thickness	10.00 ± 0.13

NOTE 1—Adjacent sides shall be at 90° ± 10 min.

FIG. 4 Izod (Cantilever-Beam) Impact Test Specimen for P/M Structural Materials

pencils, and other reasonable marking methods may be used for identification purposes. However, some marking methods can result in damage to the specimens if not used correctly. For example, excessive heat from electrostatic pencils or deformation to the specimen from stamping can change the mechanical properties of the specimen. Therefore, care shall always be taken to avoid damage to the specimen. Stamping and other marking processes that result in deformation of the specimen should only be used on the ends of the specimens, prior to notching.

NOTE 3—Careful consideration should be given before placing identification marks on the side of the specimen to be placed up when positioned

in the anvils. If the test operator is not careful, the specimen can be placed in the machine with the identification marking resting on the specimen supports (that is, facing down). Under these circumstances, the absorbed energy value obtained may be unreliable.

8. Procedure

8.1 Preparation of the Apparatus:

8.1.1 Perform a routine procedure for checking impact machines at the beginning of each day, each shift, or just prior to testing on a machine used intermittently. It is recommended that the results of these routine checks be kept in a log book for the machine. After the testing machine has been ascertained to comply with [Annex A1](#) and [Annex A2](#), carry out the routine check as follows:

8.1.1.1 Visually examine the striker and anvils for obvious damage and wear.

8.1.1.2 Check the zero position of the machine by using the following procedure: raise the pendulum to the latched position, move the pointer to near the maximum capacity of the range being used, release the pendulum, and read the indicated value. The pointer should indicate zero on machines reading directly in energy. On machines reading in degrees, the reading should correspond to zero on the conversion chart furnished by the machine manufacturer.

NOTE 4—On machines that do not compensate for windage and friction losses, the pointer will not indicate zero. In this case, the indicated values, when converted to energy, shall be corrected for frictional losses that are assumed to be proportional to the arc of swing.

8.1.1.3 The friction and windage loss shall not exceed 0.4 % of the scale range being tested and should not change by more than 10 % of the percent friction and windage loss measurements previously recorded on the machine. If the percent friction and windage loss does exceed 0.4 % or is significantly different from previous measurements, check the indicating mechanism, the latch height, and the bearings for wear and damage. However, if the machine has not been used recently, let the pendulum swing for 50 to 100 cycles, and repeat the percent friction and windage test before undertaking repairs to the machine. To ensure that friction and windage losses are within allowable tolerances, use one of the following evaluation procedures:

(1) For a machine equipped with an analog scale:

Raise the pendulum to the latched position;
 Move the pointer to the maximum scale value being used;
 Release the pendulum (without a specimen in the machine);
 Allow the pendulum to cycle five times (a forward and a backward swing together count as one cycle);
 Prior to the sixth forward swing set the pointer to between 5 and 10 % of the maximum scale value being used;
 After the sixth forward swing record the value indicated by the pointer (convert to energy if necessary);
 Divide the energy reading by 10;
 Divide by the maximum scale value being used, and
 Multiply by 100 to get the percent friction and windage loss.

(2) A machine equipped with a digital display:

Determine the percent friction and windage loss per manufacturer's procedure.

(3) For machine equipped with both an analog scale and digital display:

Determine the friction and windage loss using the same indicating device used to report absorbed energy ([10.2.5](#) and [A2.4](#)).

NOTE 5—Prior to the 2012 version, the percent friction and windage was based on 11 (half) swings and the pointer was not engaged on the first swing. Now the pointer is engaged on the first swing. The difference is that the friction, windage, and pointer losses associated with the first swing are no longer assumed to be zero. On the 1st swing the pointer should go to 0.00, so any friction that will be recorded will only show up on the following 10 (half) swings.

8.2 Test Temperature Considerations:

8.2.1 The temperature of testing affects the impact properties of most materials. For materials with a body centered cubic structure, a transition in fracture mode occurs over a temperature range that depends on the chemical composition and microstructure of the material. Test temperatures may be chosen to characterize material behavior at fixed values, or over a range of temperatures to characterize the transition region, lower shelf, or upper shelf behavior, or all of these. The choice of test temperature is the responsibility of the user of this test method and will depend on the specific application. For tests performed at room temperature, a temperature of $20^{\circ}\text{C} \pm 5^{\circ}\text{C}$ is recommended.

8.2.2 The temperature of a specimen can change significantly during the interval it is removed from the temperature conditioning environment, transferred to the impact machine, and the fracture event is completed (see [Note 8](#)). When using a heating or cooling medium near its boiling point, use data from the references in [Note 8](#) or calibration data with thermocouples to confirm that the specimen is within the stated temperature tolerances when the striker contacts the specimen. If excessive adiabatic heating is expected, monitor the specimen temperature near the notch during fracture.

8.2.3 Verify temperature-measuring equipment at least every six months. If liquid-in-glass thermometers are used, an initial verification shall be sufficient, however, the device shall be inspected for problems, such as the separation of liquid, at least twice annually.

8.2.4 Hold the specimen at the desired temperature within $\pm 1^{\circ}\text{C}$ ($\pm 2^{\circ}\text{F}$) in the temperature conditioning environment. Any method of heating or cooling or transferring the specimen to the anvils may be used provided the temperature of the specimen immediately prior to fracture is essentially the same as the holding temperature (see [Note 8](#)). The maximum change in the temperature of the specimen allowed for the interval between the temperature conditioning treatment and impact is not specified here, because it is dependent on the material being tested and the application. The user of nontraditional or lesser used temperature conditioning and transfer methods (or specimen sizes) shall show that the temperature change for the specimen prior to impact is comparable to or less than the temperature change for a standard size specimen of the same material that has been thermally conditioned in a commonly used medium (oil, air, nitrogen, acetone, methanol), and transferred for impact within 5 s (see [Note 8](#)). Three temperature conditioning and transfer methods used in the past are: liquid bath thermal conditioning and transfer to the specimen supports with centering tongs; furnace thermal conditioning and robotic transfer to the specimen supports; placement of the specimen on the supports followed by in situ heating and cooling.

8.2.4.1 For liquid bath cooling or heating use a suitable container, which has a grid or another type of specimen positioning fixture. Cover the specimens, when immersed, with at least 25 mm (1 in.) of the liquid, and position so that the notch area is not closer than 25 mm to the sides or bottom of the container, and no part of the specimen is in contact with the container. Place the device used to measure the temperature of the bath in the center of a group of the specimens. Agitate the bath and hold at the desired temperature within $\pm 1^\circ\text{C}$ ($\pm 2^\circ\text{F}$). Thermally condition the specimens for at least 5 min before testing, unless a shorter thermal conditioning time can be shown to be valid by measurements with thermocouples. Leave the device (tongs, for example) used to handle the specimens in the bath for at least 5 min before testing, and return the device to the bath between tests.

8.2.4.2 When using a gas medium, position the specimens so that the gas circulates around them and hold the gas at the desired temperature within $\pm 1^\circ\text{C}$ ($\pm 2^\circ\text{F}$) for at least 30 min. Leave the device used to remove the specimen from the medium in the medium except when handling the specimens.

NOTE 6—Temperatures up to $+260^\circ\text{C}$ may be obtained with certain oils, but “flash-point” temperatures must be carefully observed.

NOTE 7—For testing at temperatures down to -196°C (77°K), standard testing procedures have been found to be adequate for most metals.

NOTE 8—A study has shown that a specimen heated to 100°C in water can cool 10°C in the 5 s allowed for transfer to the specimen supports.⁴ Other studies, using cooling media that are above their boiling points at room temperature have also shown large changes in specimen temperature during the transfer of specimens to the machine anvils. In addition, some materials change temperature dramatically during impact testing at cryogenic temperatures due to adiabatic heating.⁵

8.3 Charpy Test Procedure:

8.3.1 The Charpy test procedure may be summarized as follows: the test specimen is thermally conditioned and positioned on the specimen supports against the anvils; the pendulum is released without vibration, and the specimen is impacted by the striker. Information is obtained from the machine and from the broken specimen.

8.3.1.1 The 8 mm striker shall be used, unless the 2 mm striker is specified.

NOTE 9—For some materials, the striker radius can significantly affect the results.

8.3.2 To position a test specimen in the machine, it is recommended that self-centering tongs similar to those shown in Fig. 5 be used (see A1.10.1). The tongs illustrated in Fig. 5 are for centering V-notch specimens. If non V-notch specimens are used, modification of the tong design may be necessary. If an end-centering device is used, caution must be taken to ensure that low-energy high-strength specimens will not rebound off this device into the pendulum and cause erroneously high recorded values. Many such devices are permanent fixtures of machines, and if the clearance between the end of a

specimen in the test position and the centering device is not approximately 13 mm, the broken specimens may rebound into the pendulum.

8.3.3 To conduct the test, prepare the machine by raising the pendulum to the latched position, set the energy indicator at the maximum scale reading, or initialize the digital display, or both, position the specimen on the anvils, and release the pendulum. If a liquid bath or gas medium is being used for thermal conditioning, perform the following sequence in less than 5 s (for $10 \times 10 \times 55$ mm specimens, see 8.2.4). Remove the test specimen from its cooling (or heating) medium with centering tongs that have been temperature conditioned with the test specimen, place the specimen in the test position, and release the pendulum smoothly. If a test specimen has been removed from the temperature conditioning bath and it is questionable that the test can be conducted within the 5 s time frame, return the specimen to the bath for the time required in 8.2 before testing.

8.3.3.1 If a fractured impact specimen does not separate into two pieces, report it as unbroken (see 9.2.2 for separation instructions). Unbroken specimens with absorbed energies of less than 80 % of the machine capacity may be averaged with values from broken specimens. If the individual values are not listed, report the percent of unbroken specimens with the average. If the absorbed energy exceeds 80 % of the machine capacity and the specimen passes completely between the anvils, report the value as approximate (see 10.1) and do not average it with other values. If an unbroken specimen does not pass between the machine anvils, (for example, it stops the pendulum), the result shall be reported as exceeding the machine capacity. A specimen shall never be struck more than once.

8.3.3.2 If a specimen jams in the machine, disregard the results and check the machine thoroughly for damage or misalignment, which would affect its calibration.

8.3.3.3 To prevent recording an erroneous value, caused by jarring the indicator when locking the pendulum in its upright (ready) position, read the value for each test from the indicator prior to locking the pendulum for the next test.

8.4 Izod Test Procedure:

8.4.1 The Izod test procedure may be summarized as follows: the test specimen is positioned in the specimen-holding fixture and the pendulum is released without vibration. Information is obtained from the machine and from the broken specimen. The details are described as follows:

8.4.2 Testing at temperatures other than room temperature is difficult because the specimen-holding fixture for Izod specimens is often part of the base of the machine and cannot be readily cooled (or heated). Consequently, Izod testing is not recommended at other than room temperature.

8.4.3 Clamp the specimen firmly in the support vise so that the centerline of the notch is in the plane of the top of the vise within 0.125 mm. Set the energy indicator at the maximum scale reading, and release the pendulum smoothly. Sections 8.3.3.1 – 8.3.3.3, also apply when testing Izod specimens.

⁴ Nanstad, R. K., Swain, R. L. and Berggren, R. G., “Influence of Thermal Conditioning Media on Charpy Specimen Test Temperature,” *Charpy Impact Test: Factors and Variables*, ASTM STP 1072, ASTM, 1990, pp. 195-210.

⁵ Tobler R. L. Et al., “Charpy Impact Tests Near Absolute Zero,” *Journal of Testing and Evaluation*, Vol 19, 1 1992.

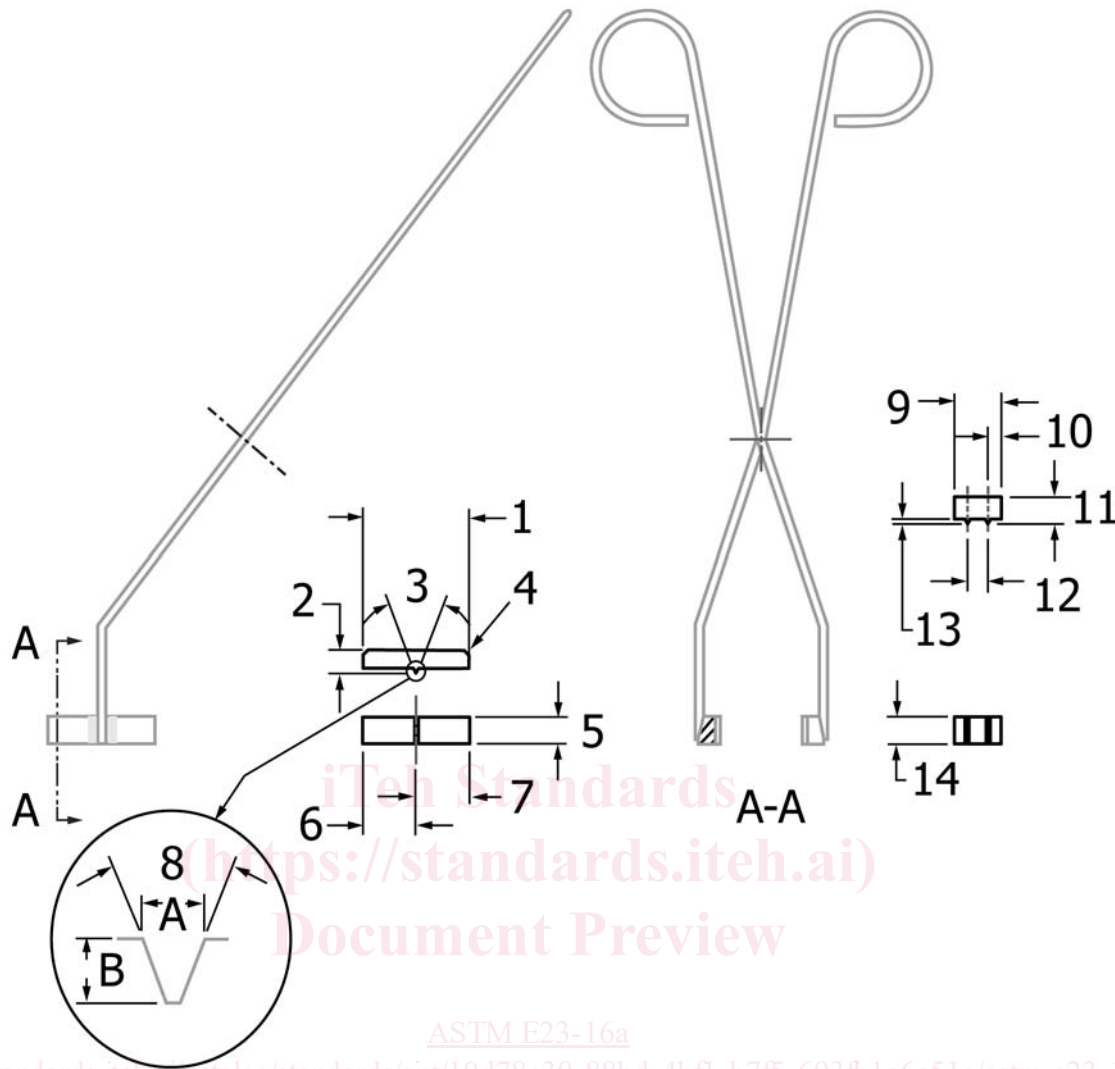

iteh Standards
<https://standards.iteh.ai>
 Document Preview

ASTM E23-16a

<https://standards.iteh.ai/catalog/standards/sist/10d78c30-88bd-4bfl-b7f5-603fb1c6c51a/astm-e23-16a>

ID Number	Designation	Dimension, mm	ID Number	Designation	Dimension, mm
1	Support (notch side) length	39.93 + 0 -0.051	8B	10 mm specimen width	1.52 to 1.65
2	Support (notch side) height	7.94 ± 1		5 mm specimen width	0.69 to 0.81
3	Insert angle	44.5 ± 0.5°	9	3 mm specimen width	0.36 to 0.48
4	Radius on support	2 ± 1	10	Solder pad length	17.46 ± 1
5	Support width	9.5 ± 1	11	Solder pad extension	4.76 ± 1
6	Notch center	19.96	12	Solder pad height	9.5 ± 1
7	Notch center	19.96	13	rod	7.94 ± 1
8A	10 mm specimen width	1.60 to 1.70	14	Solder pad width	1.588 ± 1
	5 mm specimen width	0.74 to 0.80			9.5 ± 1
	3 mm specimen width	0.45 to 0.51			

FIG. 5 Centering Tongs for V-Notch Charpy Specimens

9. Information Obtainable from Impact Tests

9.1 *The absorbed energy* shall be taken as the difference between the energy in the striking member at the instant of impact with the specimen and the energy remaining after breaking the specimen. This value is determined by the machine's scale reading which has been corrected for windage and friction losses.

NOTE 10—Alternative means for energy measurement are acceptable

provided the accuracy of such methods can be demonstrated. Methods used include optical encoders and strain-gaged strikers.

9.2 *Lateral expansion measurement* methods must take into account the fact that the fracture path seldom bisects the point of maximum expansion on both sides of a specimen. One half of a broken specimen may include the maximum expansion for both sides, one side only, or neither. Therefore, the expansion on each side of each specimen half must be measured relative

to the plane defined by the undeformed portion on the side of the specimen, as shown in Fig. 6. For example, if A_1 is greater than A_2 , and A_3 is less than A_4 , then the lateral expansion is the sum of $A_1 + A_4$.

9.2.1 Before making any lateral expansion measurements, it is essential that the two specimen halves are visually examined for burrs that may have formed during impact testing; if the burrs will influence the lateral expansion measurements, they must be removed (by rubbing on emery cloth or any other suitable method), making sure that the protrusions to be measured are not rubbed during the removal of the burr. Then, examine each fracture surface to ascertain that the protrusions have not been damaged by contacting an anvil, a machine mounting surface, etc. Lateral expansion shall not be measured on a specimen with this type of damage.

9.2.2 Lateral expansion measurements shall be reported as follows. An unbroken specimen can be reported as broken if the specimen can be separated by pushing the hinged halves together once and then pulling them apart without further fatiguing the specimen, and the lateral expansion measured for the unbroken specimen (prior to bending) is equal to or greater than that measured for the separated halves. In the case where a specimen cannot be separated into two halves, the lateral expansion can be measured as long as the shear lips can be accessed without interference from the hinged ligament that has been deformed during testing. The specimen should be reported as unbroken.

9.2.3 Lateral expansion may be measured easily by using a gage like the one shown in Fig. 7 (assembly and details shown in Fig. 8). Using this type of gage the measurement is made with the following procedure: orient the specimen halves so that the compression sides are facing each other, take one half of the fractured specimen and press it against the anvil and dial gage plunger and record the reading, make a similar measurement on the other half (same side) of the fractured specimen and disregard the lower of the two values, do the same for the other side of the fractured specimen, report the sum of the maximum expansions for the 2 sides as the lateral expansion for the specimen.

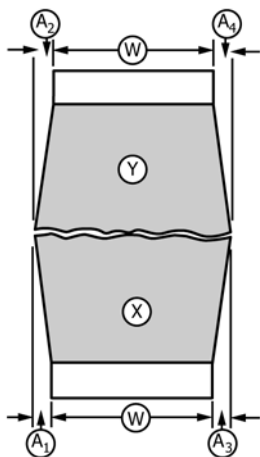

FIG. 6 Halves of Broken Charpy V-Notch Impact Specimen Illustrating the Measurement of Lateral Expansion, Dimensions A_1 , A_2 , A_3 , A_4 and Original Thickness, Dimension W

9.3 The percentage of shear fracture on the fracture surfaces of impact specimens may be determined using a variety of methods. The approach and the acceptable methods are defined in Annex A4. For each method, the user must distinguish between regions formed by stable crack growth mechanisms, and regions formed by unstable crack growth mechanisms. For purposes of this Test Method, the “shear area” consists of those portions of the fracture surface that form by stable crack growth (Fracture Initiation Region, Shear Lips, and Final Fracture Region), as shown in Fig. 9.

The percent shear area on the fracture surface of a Charpy impact specimen is typically calculated as the difference between the total fractured area (Fracture Initiation Region, Shear Lips, Unstable Fracture region, and Final Fracture Region) and the area of unstable fracture region, divided by the total fractured area, times 100. The measurement methods described in Annex A4 provide estimates for the area of the unstable fracture region (directly or indirectly), but do not consider details of the fracture mode for the unstable region. The unstable fracture region could be 100 % cleavage, a mixture of cleavage and ductile-dimple fracture morphologies, a mixture of intergranular and ductile-dimple fracture morphologies, or a mixture of other fracture morphologies.

NOTE 11—Carbon steels often exhibit a classic cleavage region that identifies the unstable fracture region with a well-defined area of shiny fracture that is easy to recognize and measure. Other steels, such as quenched and tempered SAE 4340, alloys have a region of unstable fracture that consists of an intimate mixture of cleavage facets and ductile dimples (only apparent at high magnifications). Some embrittled steels can exhibit partially intergranular fracture, as well. In these cases the area of unstable fracture may not be as easy to identify.

10. Report

10.1 Absorbed energy values above 80 % of the scale range are inaccurate and shall be reported as approximate. Ideally an impact test would be conducted at a constant impact velocity. In a pendulum-type test, the velocity decreases as the fracture progresses. For specimens that have impact energies approaching 80 % of the capacity of the pendulum, the velocity of the pendulum decreases (to about 45 % of the initial velocity) during fracture to the point that accurate impact energies are no longer obtained.

10.2 For commercial acceptance testing, report the following information (for each specimen tested):

- 10.2.1 Specimen type,
- 10.2.2 Specimen size (if sub-size specimen),
- 10.2.3 Test temperature,
- 10.2.4 For Charpy testing specify the striker radius as 8 mm or 2 mm,
- 10.2.5 Absorbed energy, and
- 10.2.6 Any other contractual requirements.

10.3 For other than commercial acceptance testing the following information is often reported in addition to the information in 10.2:

- 10.3.1 Lateral expansion,
- 10.3.2 Unbroken specimens,
- 10.3.3 Fracture appearance (% shear, See Note A4.1),
- 10.3.4 Specimen orientation, and
- 10.3.5 Specimen location.

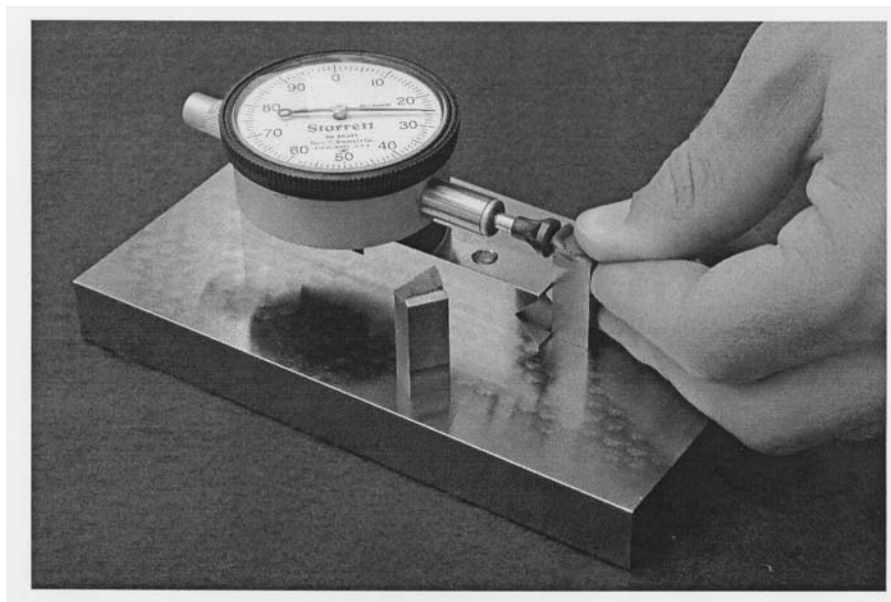

FIG. 7 Lateral Expansion Gage for Charpy Impact Specimens

NOTE 12—Even when the test temperature is specified as room temperature, report the actual temperature.

11. Precision and Bias

11.1 *An Interlaboratory study* used CVN specimens of low energy and of high energy to find sources of variation in the CVN absorbed energy. Data from 29 laboratories were included with each laboratory testing one set of five specimens of each energy level. Except being limited to only two energy levels (by availability of reference specimens), Practice E691 was followed for the design and analysis of the data; the details are given in ASTM Research Report No. RR:E28-1014.⁶

11.2 *Precision*—The *Precision* information given below is for the average CVN absorbed energy of five test determinations at each laboratory for each material.

Material	Low Energy J	High Energy J
Absorbed Energy	15.9	96.2
95 % Repeatability Limit	2.4	8.3
95 % Reproducibility Limits	2.7	9.2

The terms repeatability and reproducibility limit are used as defined in Practice E177. The respective standard deviations among test results may be obtained by dividing the above limits by 2.8.

11.3 *Bias*—*Bias cannot be defined* for CVN absorbed energy. The physical simplicity of the pendulum design is complicated by complex energy loss mechanisms within the machine and the specimen. Therefore, there is no absolute standard to which the measured values can be compared.

12. Keywords

12.1 Charpy test; fracture appearance; impact test; Izod test; notched specimens; pendulum machine

⁶ Supporting data have been filed at ASTM International Headquarters and may be obtained by requesting Research Report RR: E28-1014.

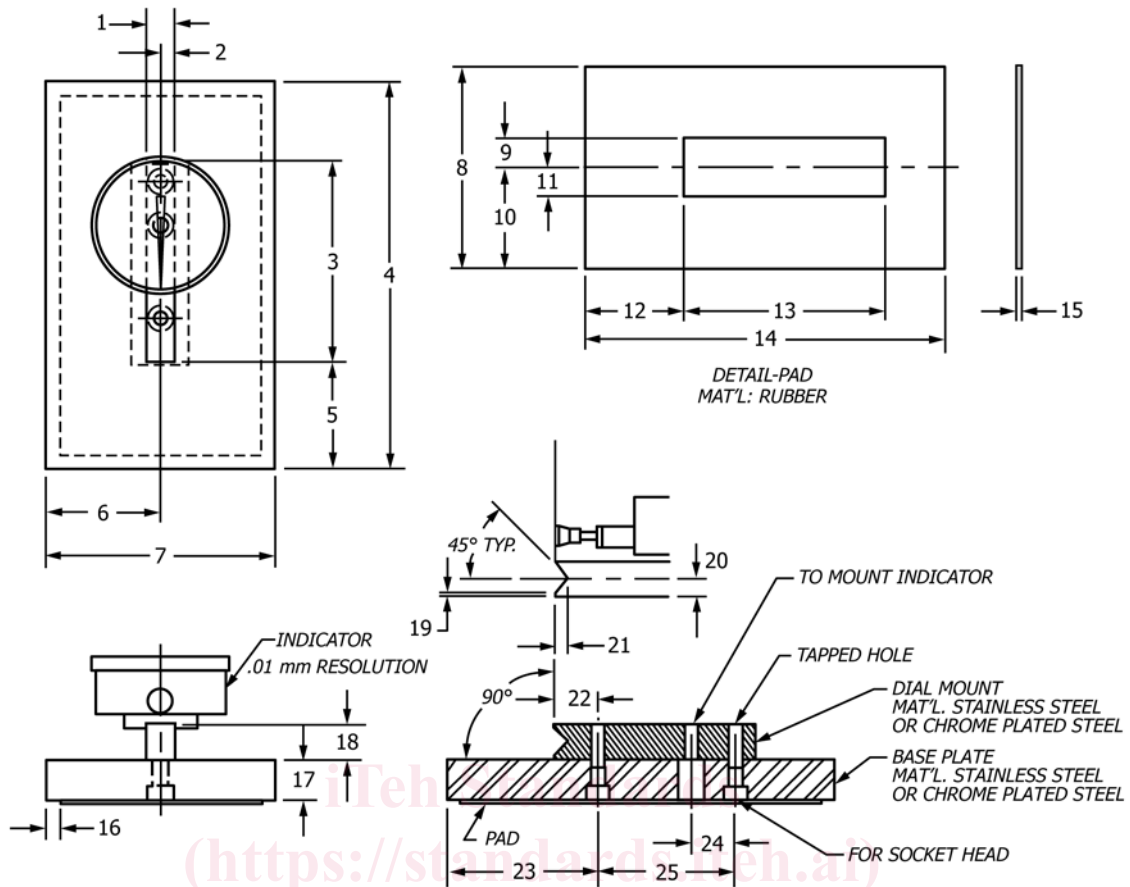

ID Num	Dimension, mm	ID Num	Dimension, mm
1	12.7	15	1.59
2	6.4	16	6.4
3	88.9	17	17.5
4	171.5	18	15.9
5	47.6	19	1.7
6	50.8	20	0.5
7	101.6	21	8.3
8	88.9	22	3.2
9	12.7	23	6.1
10	44.5	24	19.1
11	12.7	25	66.7
12	43.2	26	19.1
13	88.9	27	60.3
14	158.8		

FIG. 8 Assembly and Details for Lateral Expansion Gage

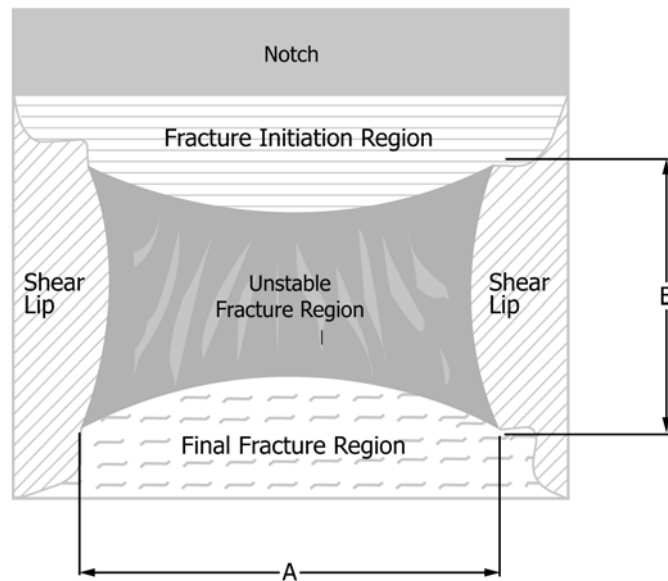

NOTE 1—Measure average dimensions A and B to the nearest 0.5 mm. Determine the percent shear fracture using Table A4.1 or Table A4.2.
FIG. 9 Schematic of the Fracture Surface of a Charpy V-Notch Impact Test Specimen Showing the Various Region of Fracture

ANNEXES

(Mandatory Information)

A1. GENERAL REQUIREMENTS FOR IMPACT MACHINES

A1.1 *The machine frame* shall be equipped with a bubble level or a machined surface suitable for establishing levelness of the axis of pendulum bearings or, alternatively, the levelness of the axis of rotation of the pendulum may be measured directly. The machine shall be level to within 3:1000 and securely bolted to a concrete floor not less than 150 mm thick or, when this is not practical, the machine shall be bolted to a foundation having a mass not less than 40 times that of the pendulum. The bolts shall be tightened as specified by the machine manufacturer.

A1.2 *A scale or digital display*, graduated in degrees or energy, on which readings can be estimated in increments of 0.25 % of the energy range or less shall be furnished for the machine.

A1.2.1 The scales and digital displays may be compensated for windage and pendulum friction. The error in the scale reading at any point shall not exceed 0.2 % of the range or 0.4 % of the reading, whichever is larger. (See A2.3.8.)

A1.3 *The total friction and windage losses* of the machine during the swing in the striking direction shall not exceed 0.75 % of the scale range capacity, and pendulum energy loss

from friction in the indicating mechanism shall not exceed 0.25 % of scale range capacity. See A2.3.8 for friction and windage loss calculations.

A1.4 *The position of the pendulum*, when hanging freely, shall be such that the striker is within 2.5 mm from the test specimen. When the indicator has been positioned to read zero energy in a free swing, it shall read within 0.2 % of the scale range when the striker of the pendulum is held against the test specimen. The plane of swing of the pendulum shall be perpendicular to the transverse axis of the Charpy specimen anvils or Izod vise within 3:1000.

A1.5 *Transverse play of the pendulum* at the striker shall not exceed 0.75 mm under a transverse force of 4 % of the effective weight of the pendulum applied at the center of strike. Radial play of the pendulum bearings shall not exceed 0.075 mm.

A1.6 *The impact velocity* (tangential velocity) of the pendulum at the center of strike shall not be less than 3 nor more than 6 m/s.